

A black and white photograph of a swimming pool lane. A lane line with white buoys runs diagonally from the top left towards the bottom left. The water is rippled. At the top of the pool, there are depth markers: "5FT" on the left and "7FT" on the right. The company name "Hatchik Supply Co." is overlaid in large, bold, black letters with a white outline at the top center.

Hatchik Supply Co.

**5260 Port Royal Road
Springfield, Virginia 22151**

(703) 321-7699

Fax:(703) 321-8478

**4050 Penn-Belt Place
Forestville, Maryland 20747**

(301) 420-5960

Fax:(301) 420-1141

**Toll Free Fax
800-321-8479**

WWW.HATCHIKSUPPLY.COM

TERMS & CONDITIONS

- Ordering:** To insure prompt and proper shipment, please order by catalog number and description. When ordering items not fully covered, please furnish sufficient information to allow us to properly fill your order.
- Terms:** Net 30 days to established and approved accounts. A service charge of 1-1/2% per month will be made on all accounts 30 days or more past due.
- New Accounts:** When placing initial order, give 3 credit references and name of bank along with Tax Exemption Certificate for sales tax.
- Minimum Order:** All orders less than \$50.00 will be shipped freight collect and a \$5.00 service charge will be added.
- Returnable Containers:** All returnable containers remain our property and must be returned within 90 days in good condition to receive credit. Charges will be made for containers damaged through abuse and for closures that are missing.
- Shortages:** Shortages must be reported within 5 days from receipt of goods. No Exceptions. No credit will be issued after this time has expired.
- Warranty:** All products carry manufacturer warranties and their warranties are the sole responsibility of the manufacturer. There are no other warranties valid, neither expressed nor implied and we cannot be held responsible for damages.
- Returns:** No returns allowed without permission of billing office. Returns are subject to 20% restocking charge and must be accompanied by invoice and date of purchase. Leftover merchandise will not be taken back at the end of season. Special orders of non-stocking items are non-returnable. All freight charges will apply.
- Prices:** Prices are subject to change without notice.
- Quotes:** We stock and/or have access to many parts and products not included in this catalog. We would appreciate the opportunity to quote on your requirements. For your convenience, please use our 1-800-321-8479 toll free fax number and we'll be happy to get back to you.
- Special Orders:** Certain items in this catalog are not in stock and are considered a special order. On all special orders we require a 50% deposit when order is placed. Subsequent cancellations or returns will be dealt with at the customer's expense. All special orders are F.O.B. factory.

POSSESSION OF THIS CATALOG DOES NOT CONSTITUTE AN OFFER TO SELL

Table of Contents

iii

Above Ground Pools & Equipment...	272-284	Main Drains	195-197
Alarms	257-258	Maintenance Pumps	76-77
Alternative Pool Care	20, 21, 22	Misc. Service Equipment.....	220-221
Automated Controllers	38	Motors & Parts	151-156
Automatic Pool Cleaners	53-62	Multiport & Push-Pull Valves	120-121
Brass Fittings	209	New Water System	23
Brick Coping & Pavers	248-251	Ozonators	33-34
Brushes	74-75	Paint & Paint Accessories	223-225
Bulk Sanitizers	12	Patio Accessories	255-256
Bulk Water Treatment.....	13	Plaster and Cement	226-228
Cartridge Filters & Cartridges	122-131	Polaris & Letro Common Parts (Appendix A)	293
Cement & Plaster	226-228	Poles & Pole Accessories	72-73
Ceramic Pool Tile	243-247	Poly & Vinyl Tubing	45
Chemical Feeders	39-41	Pool Fittings	191-193
Chemicals	1,12-30	Pool Repair	229-234
Chlorinators	42-44	Portable Vacuum Systems.....	63
Chlorine Systems	31, 32	Pump Repair Kits & Accessories	150
Chlorine Generators & Supplies	35-37	Pumps	135-149
Cleaning Products.....	14	Pump Seals & Gaskets	158
Commercial Dive Stands	95, 96	PVC: Cement & Unions	210
Commercial Filters	100-102	PVC: Fittings	204-210, 216
Commercial Heaters	103-104	PVC: Pipe.....	203
Commercial Pumps, Strainers	105-109	Racing Lanes & Reels	86-87
Control Systems	181-183	Rail Goods	81-85
Deck: Drains, Forms, Control Joints .	238-242	Replacement Cartridges	126-131
D.E. Filters & Grids	114-119	Replacement D.E. Grids.....	118-119
Diving Boards & Stands	92-98	Replacement Liners	284
Fiber Optic Lighting	170-171	Repair Couplings.....	216
Filter Media	14	Rope Anchors & Sylvan Parts	194
Filter Repair Kits & Accessories.....	132-133	Sand Filters	110-113
Flange Bolt Chart (Appendix B).....	294	Signs	259
Flanges & Wafer Valves	211	Skimmers: Vinyl, Concrete, & Parts ..	198-202
Floats & Rope	260	Solar Blankets & Reels	269-271
Floating Lounges	265	Spa Equipment	184-190
Flowmeters	134	Spa Heaters & Accessories	169
Frog Mineral Products	24	Starting Platforms	88
Goggles, Masks, Snorkels	264	Surplus & Closeouts	292
Goggles, Safety	222	Swimming Aids	263
Hair & Lint Strainers	109	Swimming Pool Games	268
Handicapped Access	99	Terms & Conditions	i
Heaters	103-104, 159-167	Test Kits, Reagents, & Strips	46-51
Heat Pumps	168	Test Plugs	217
Hoses & Accessories	64-65, 79-80	Threaded Plugs & Brass Fittings	209
Hoses: Discharge	79	Thermometers	52
Hoses: Garden	80	Timers & Controls	180-184
Hoses: Vacuum.....	64-65	Tools	218-220
Inflatables	265-267	Trash Pumps & Suction Hose.....	77-79
Insert Fittings	208	Vac Heads: Residential & Commercial .	66-68
Leaf Traps	69	Vacuum Hose & Accessories	64-65
Leaf Skimmers & Rakes.....	70, 71	Valves: Check Valves & Ball Valves ..	212-215
Lifeguard Stands	97-98	Wafer Valves	211
Lifeguard & Safety Equipment	261-262	Water Basketball & Volleyball	89, 268
Lighting: Above Ground	282	Water Features	252-254
Lighting: Underwater	172-179	Water Slides	90-91
Liners	274-275, 284	Winterizing Products	285-292
Liner Accessories	283	Work and Safety Apparel	222
Lubricants & Sealants	235		

A

- A.O. Smith Motors . 5,151-155, 258
A-Frame Ladders 280-281
Above Ground Cleaners 55,56,58,60
Above Ground Heaters 168
Above Ground Ladders 280-281
Above Ground Liners 274-275
Above Ground Lighting 282
Above Ground Alarms 258
Above Ground Pool Kits ... 272, 273
Above Ground Systems ... 276-279
Acid Brush 75
Acid Drum Spigot 13, 221
Acid Drum Wrench 13, 219
Acid, Muratic 13
Acid Sprayer 13
Acryl 60 229
Accent Lighting 256
Accu-Tabs 12,31
Aerator Nozzle 193
Air Blowers 187
Air Pillows 289
Air Pumps 266
Air Switches 190
Aladdin Go Kits 150
Aladdin O-Ring Kits 132
Alarms, Pool 257-258
Algae Brush 75
Algaecides .. 16,18,20,23,25,28,285
Algae-Gon Remover 73
All Chlor Chemicals 12, 15-16, 285
Allen Wrench 219
Alum Flock 13 ,16, 25
Aluminum Anchor Sockets 84
Aluminum Deck Anchors 84-85
Aluminum Dive Boards 92
Amerlite Pool Lights 172-173
Anchor Flanges 85
Anchor Sockets 84-85
Anchor-Tite 229
Anchor Wedges 84
Anthony D.E. Grids 119
Anthony Dive Boards 93
Antifreeze 285
Anti-Hair Snair Plus 196
Anti-Hair Grate Screws 197
Anti-Scald Valves 212
Anti-Wave Racing Lanes 86
Anzen Air Blowers 187
Apron (Chemical Aprons) 222
Aquabot 54
Aquabrome 12,18
Aquabug 56
Aqua-Chek Test Strips 51
AquaCover Reel Systems 270
Aqua-Creek EZ Lift Hydraulic 99
Aquador Face Plates 291
Aqua Flo Pumps 106,135
Aquaflower Fountain 253
Aqua Garden 252
Aqua Gloves 222
Aqua King 53
Aqua-Light 172-173
Aqua Link Controls 181-183
Aquality Test Kit Reagents 49
Aquality/Sta-rite Vac Heads 67
Aqua Lube 235
Aqua Lumin II Lights 172,178
Aqua Lumin Parts 438
Aqua Luminator 282
Aqualuster Paint 224
Aquamist Poxolon Paint 223
AquaPure Chlorine Generator . 2,35
AquaRite Inground CL Gen. 35
AquaRoller 265
AquaTrol Above Grd CL Gen. 35
Aqua Set Controls 184
Aqua Smart Cyclor Pacs 23
Aqua Trek Entry Ramp 99
Aqua Vac Systems 53
Aqua Wrenches 219
Arm Floats 263
Ascorbic Acid 29
Astral Chemical Feeders 40
Astral Filters 100
Astral Ladders 81
Astral Lifeguard Chair 98
Astral Starting Platforms 88
Astral Vac Heads 66-67
Astral Valves 211-213
Auto Fill 193
Automatic Cleaners 53-62
 Aqua Products 54
 Aqua Vac 53
 Dolphin 55
 Baracuda 55
 Hayward 56
 Jandy Ray-Vac 58
 Jandy Ray-Vac Parts 59
 Letro 56
 Letro Common Clnr Parts 57
 Polaris 60-62
 Polaris Common Parts 61-62
 Sta-Rite 58
 Zodiac 55
Automatic Cleaner Parts 295
Automatic Water Leveler 193
Automated Chem. Ctrl. 38
Avalanche D.E. Filters 278
Azure Float-N-Deck Lounger 266
- B**
- Baby Seat 263
Backboards (Spine Board) 262
Backer Rod 232
Backstroke Flags 85
Backup Valves (Polaris) 61, 62
Bacteria Test Kit (Silver Lake) ... 46
Ball Valves 212-213
Baracuda Pool Cleaners 55
Basketball Games 89,268
Baskets (Hair & Lint Strainers) 109
Baskets 11, 446-453
Baskets, Residential 446-449
Baskets, Commercial 450-453
Beach Balls 266
Bearings, Motor 155
Bermuda Skimmers (Pentair) ... 199
Beta Above Ground Cleaner 55
Biguanide Products 20
Bilge Pumps 77
Biturez (Kelly Paint) 223
Black Algae Scrapper 73
Black Pool Fittings 191,193
Black Max (Polaris) Cleaners ... 62
Bleeder Valves 111, 209
Bloodspill Kit 262
Blossom Lites 255
Blower Replacement Motors ... 187
Blowers, Air 187
Blow Outs 289
Blue Devil CL/Brominators 39
Blue Devil Vac Heads 66
Blue Devil Hand Skimmers 70
Blue White Feeders 42
Blue White Flowmeters 134
Bonding Grid/Matt 240-241
Booster Pumps 61, 326-327
Boots 222
Boss Silicone 230
Brass Anchor Sockets 84
Brass Fittings 209
Brass Hose Couplings 80
Brass Thermometer 52
Brick Coping 248-249
Brick Pavers 250-251
Brominators 39-40
Bromine 12-29
Bromine Dispenser 39-41
Bromine Initiator 20
Bromine Testing 46-51
Bronze Anchors 85,95
Bronze Ball & Gate Valves 212
Bronze Check Valves 215
Brushes 74-75, 188, 225
 Acid 75
 Algae 75
 Floor 75
 Paint 225
 Scrub 74,75
 Scumbrush 188
 Wall 74
 Wall Whale 74

Bulk Chemicals 12-13
 Bulk Reagent Solutions 49
 Bulkhead Fittings 165,189,192
 Bucket Grids 225
 Bullnose Brick Coping 248-249
 Bullnose Tile 244
 Bumble Bee Hi-Vac Hose 78
 Bushings - Reducer 206, 209
 Butterfly Valves 211
 Butyl Tape 179

C

Calcium

Antifreeze 285
 Chloride 13
 Hardness 13,16,18,26
 Hypochlorite 12,15,17
 Hardness Tests 46,47,50
 Releaser 1, 14
 Cams, Pole 73
 Candles, Floating 255

Cantar

A/G Pool Kits 272-273
 Liners 274
 Safety Covers 286
 Solar Blankets 269
 Solar Reels 270
 Cantilever Deck Forms 240
 Cantilever Lifeguard Stand 97
 Capacitors 155
 Carboy Cap Wrench 12,219
 Caretaker Parts 194
 Carrying Strap for Vac Hose ... 220
 Cartridge Filter Cleaners ... 16,18-20

Cartridge Filters 122-125

Harmsco 124
 Hayward 122-123
 Jacuzzi 124
 Pentair 125
 Sta-Rite (Pentair) 125

Cartridge Filter Parts 329

Cartridge Filter Purifiers 22,24
 Cartridges, Replacement .. 126-131
 CAT Controllers 38
 Caulk 231
 Caulking Guns 232
 Cement 226
 Cement, PVC 210
 Ceramic Pool Tile 243-246
 CGM Products 229
 Chaise Lounges (Floating) 265
 Challenger Pumps 145
 Channel Grates & Drains 239
 Channel Lock Pliers 219
 Chateau Pool Kit 273
 Check Valves 215, 292
 Chemical Apron 222

Chemical Feeders ... 23, 24, 39-41

Assorted Floating 39
 Astral 40
 Biolab/Chemtura/Omni 40
 Hayward 39
 King Technology 23, 24, 40
 MA Feeder 40
 New Water & Frog 23-24
 Rainbow / Pentair 40, 41

Chemicals 12-31

All Chlor 12, 15, 16
 Bulk 12-13
 Clear Comfort 20
 Frog 24
 GLB 12, 25-26
 IBS Enzymes 29
 Jack's Magic 28
 Jonas 29
 King Technology 23-24
 Natural Chemistry 27-28
 Nature 2 21-22
 New Water 23
 Omni 12, 17-19
 PolyClear 20
 PPG 12, 31
 Sea-Klear 29
 Specialty Chemicals 25-30
 Simplicity 18
 Swimfree 30
 Synergy 20
 Vanson 29
 Zodiac 21-22

Chemical Scoops 14,221

Chem-Tec Feeders 44

Chlorinators 42-44

Blue White 42
 Chem Tech 44
 Rola-Chem 43
 Stenner 43

Chlorinator Oil 44

Chlorine Dispensers 39

Chlorine Generators 35-37

Balboa 35
 Del 36
 Goldline / Hayward 35
 Intermatic 37
 Jandy 35
 King Pool Frog 36
 Pentair 37
 Polaris 35
 Smartpool 35
 Zodiac 36

Chlorine, Liquid 12

Chlorine Products 12-31

Chrome Fittings 192, 194

Chrome Plastic Escutcheons ... 85

Chrome Thermometers 52

Circulator, The 10, 191

Claritec (Nature 2) 21-22

Classic Winter Cover 287-288

Clean & Clear A/G System 279

Cleaner, PVC 210

Cleaner Parts 295

Cleaning Products 14

Clean Out Plugs 209

Clean Out Plug Wrench 219

Clear Blue 25

Clear Comfort 20,292

Clear Vinyl Hose 65

Clocks, Outdoor 255

Clocks, Time 180,190

Closed Test Plugs 217

CO2 System 32,38

Coates Pool Heaters 103

Coates Spa Heaters 103,169

Collector Tubes 196

Colored Lenses 178,256

Commercial Equipment

Baskets 11, 202,450-453

Blowers 187

Cleaners 53-55

Chlorine Generators 35

Deck Forms 240

Deck Bonding Grid System .. 241

Diving Boards & Stands 92,95-96

Filters 100-102,110-112

Handicapped Access 99

Heaters 103-104,159

Ladders / Railgoods 81-85

Ozonators 34

Poles 8,72

Pumps 105-108,148

Motors 156

Signs 259

Skimmers 70

Slides 90

Solar Blankets 269

Strainers 109

Stingl Switch 258

Test Kits 46

Vac Heads 66

Vac Hose & Equipment 64-65

Volleyball 89

Wall Brush 74

Commercial Heaters 103-104

Commercial Pumps 105-108

Commercial Pump Motors 156

Competitor Racing Equip. 87

Competitor's Deck Drain 239

Competitor's Control Joint 239

Compression Fittings 210

Concrete Mix 226

Concrete Repair 228-229

Conduit & Fittings 179

Confer Ladders 280

Control Joint 238-239

Controllers, Chemicals 31,38
 Controllers, Pool & Spa 180-185
 Coping Stone 248-251
 Copper Fittings 209
 Copper Test Kits 48, 50, 51
 Cord Reel 220
 Cord Set for Pumps 137
 Cord Stopper 179
 Corona Discharge Ozone 34
 Cover Pumps 76-77
 Covers, Winter 286-288
 Covers, Heater & Dive Board... 291
 Covers, Racing Lane Reel..... 86-87
 CPVC Pipe & Fittings 203,207
 CPVC Valves 214-215
 Crack Repair Kit 232-233
 Cross Brace Ladders 81
 Crystal Clear 17
 Cup Anchors 194
 Custom Cascades 253
 Custom Mosaics 245
 Cyanuric Acid 13,18
 Cyanuric Acid Test Kits 46-51
 Cygnet Pump 142

D

Dampset Paint 224
 D.E. Filter Powder 1,14
D.E. Filters 114-117
 Hayward 115
 Jacuzzi 114
 Jandy 114
 Pentair 116-117
 Separation Tanks 117
 D.E. Replacement Grids ... 118-119
 D.E. Scoops 14,221
 Deck Anchor Flanges 85,286
 Deck Drain 238-240
 Deck Forms 240
 Deck Joint 238-239
 Deck Level Dive Stand 96
 Deck Level Stair Rails 82
 Deckmate Skimmer ... 199,201-202
 Deck Paint 224
 Deck-O-Seal 230
 Del Ozonators 33-34
 Deluxe Spa Covers 188
 Depth Markers 246-247
 Derby Ducks 255
 Dichlor 15,17,26
 Digi-Flow Flowmeter 134
 Discharge Hose 79
 Disposable Gloves & Masks... 222
 Disposable Aprons 222
 Dive Board Hardware 94
 Dive Stands 93-96
 Diving Boards 92-93,95

Diving Board Covers 291
 Diving Board Resurfacing Kits ... 93
 Diving Brick 261
 Dolphin Cleaners 54-55
 Doline A/G Ladders 281
 Double Union Valves 7,212
 DPD Test Tablets 46-50
 Drain King 221
 Drill Bits 218
 Drop In Steps 280
 Dry Works Dry Bed 221
 Duck Chlorinator 39
 Duck Thermometers 52
 Ducks, Floating 255
 Duct Tape 220, 225
 DuraFlex Diving Boards 95
 Dura-Glas Pumps 148
 DuraGrid Equipment Pads 132
 Duro-Beam Dive Boards 93
 Dust Masks 222
 Dye Test Syringes 220
 Dye, Uranine 220
 Dyna-Glas Pumps 149

E

Ear Plugs 264
 Earthworks D.E. Filter 114
 Eclipse Ozonators 34
 Electrical Accessories 179
 Electrical Tape 155, 220
 Electric Heaters 169
 Emergency Blanket 262
 Emergency Equipment 261-262
 E-MOD Motors 5,153, 258
 Entrapment Reduction Kit 196
 Enzymes 29
 Epoxy Paint 7, 223-224
 Epoxy Putty 233-234
 Epoxy Spray (Sure Traction)... 225
 Equipment Pads 132
 Erosion Feeders 39-40
 Escutcheon Plates 85
 Estate A/G Pool Kits 272
 Estate Winter Covers 287-288
 Hayward/EUS Heat Pump 168
 Exercise Bar 83
 Expansion Foam 232
 Expansion Joint & Base .. 232, 238
 Expansion Repair Coupling 216
 Extended Plugs 290
 Extrication Collars 262
 Eyeball Fittings 191
 Eyeball Removal Tools 191
 Eyeball Seat Wrench 191, 219
 Eyebolts 194
 E-Z Out Skimmer Basket 198, 202

F

Fast Orange Cleaner 14
 Feeders 23,24,39-41
 Feherguard Reels 271
 Fence, Inground Safety 256
 Fiberglass Poles 72
 Fiber Optic, Deck Forms For .. 240
 Fiber Optic Lighting..... 93,170-171
 Fiber Optic Silicon 230
 Fiberstars Lighting 254
 Fiberworks 170
 Fibre-Optic Dive Boards (T7) ... 93
 Figure Four Handrails 3, 83
 Fill Spouts 193
 Filter Aid 18
 Filter Bases 132
 Filter Cartridges 126-131
 Filter Grids 118-119
 Filter Media 14
 Filter O-Ring Kits 132
Filters ... 100-102,110-117,122-125
 Cartridge 122-125
 Commercial 100-102
 D.E. 114-117
 Sand 110-113
Filter Parts 329-368
 Fins 264
 Fire Hose Nozzle 80
 First Aid Kits 262
Fittings
 Bulkhead 192
 Brass 209
 Eyeball 191
 For Poly and Vinyl Tubing 45
 Inlet/Outlet 192-194
 Insert 208
 PVC 204-207
 Return 192
 Spa 189
 SwimJet 193
 Flange Bolts 211
 Flange Gaskets 211
 Flanges, PVC 211
 Flange Bolt Chart 294
 Flex-Vac Heads 66-67
 Flexible PVC Pipe 203
 Floating Baby Seat 263
 Floating Blossom Lites 255
 Floating Dispensers 39
 Float Valves 31, 132, 198-199
 Floats, Pool 265-266
 Floats, Rope 260
 Flo-Master Pumps 135
 Floor Brush 75
 Floor Returns 193
 Floor Squeegies 75
 Floor Tiles 245
 FNS D.E. Filter 116-117

Flow Meters 40-41, 134
 Foam Expansion Joint 232
 Foam Joint Filler 232
 Foam Spa Blanket 188
 Foot Bath 255
 Footboards 97-98
 Foot Pumps 266
 Fountains 253-254, 282
 Fountain Lights 6, 172
 Fox Whistles 261
 Frames & Grates 195-197
 Frog Mineral Products 24
 Frontier Diving Board II & III 92
 Frontier Deck Drains 240
 Frost-Proof Tile 243-246
 Fulcrum Bumpers 93
 Fulcrum Covers 97-98

G

Games 89, 268
 Garden Hose 80
 Garden Hose Valves 80, 212
 Gas Heaters 104, 159-167
Gaskets 158, 178, 211
 Flange 211
 Light 178
 Pump 158
 Gas Powered Pumps 10, 77-78
 Gate Valves 212
 Gel Gloss 90
 Geophone 220
 Georgia Marble Dust 226
 Giant Leaf Basket 221
 Giant Wall Brush 74
 Giant Water Tube 267
 Gizzmos 289
 Glass Hide Dive Boards 92
 Gloves 222
 Glue, PVC 210
 Goggles, Safety 222
 Goggles, Swimming 264
 Go-Kits 150
 Grab Rails 82-83
 Grates 195-197
 Gravel & Sand 14
 Great American Ducks 52, 255
 Great Lakes Biochemical . 1, 25-26
 Great White Cleaners 58
 Gray Fittings 191-193, 209
 Gray Grates 197
 Gray Deck Drain 238-239
 Gray Pool Mix 226
 Gray Sealants 231
 Gray Skimmers 199
 Gray Tiles 245

Grout Clean-up Scrubber 220
 Grout, Tile 229-230
 Grout & Plaster Repair ... 228-230
 Guard Chairs 94, 97-98
 Guard Chair Umbrella 261
 Guard Patch 261
 Gutter Drains 193

H

H-Series Heaters, Hayward 166-167
 Hack Saws 218
 Hair & Lint Strainers 106, 109
 Hand Cleaners 14
 Handicap Lifts 99
 Handles, Wooden Pole 75, 225
 Handles, Hose 79
 Handrail Plug 219
 Handrails 82-83
 Hand Skimmers 70
 Hanna Testing Equipment 3, 48

Hayward

Baskets ... 202, 447-448, 450, 452
 Chlorinators 39
 Chlorine Gen. (Goldline) 2, 35
 Cleaners 56
 D.E. Grids 119
 Filters 112, 113, 115, 122-123
Filter Parts, Cartridge 331
Filter Parts, D.E. 341-342
Filter Parts, Sand 355-357
 Fountains 253
 Heaters 166-167
Heater Parts 391-399
 Leaf Traps 69
 Lights 174-175
 Mineral Purifying System 123
 Multiport Valves 120
 Pool Fit./White Goods .. 191-201
 Pumps 4, 136-139
Pump Parts 372-387
 Replacement Cartridges 126-127
 Seals 158
 Skimmers 200
 Spa Fittings 189
 Vac Heads 68
 Valves 213-215
 Weirs 202

Head Immobilizers 262

Heaters 103-104, 159-167, 169

Brett Aqualine 169
 Coates 103, 169
 Commercial 103-104
 Covers 291
 Electric 103, 169

Heaters (Cont.)

Hayward 166-167
 Heat Pumps 168
 Laars 104, 159-161
 Pentair 165-166
 Raypak 162-164
 Spa 103, 166, 169
 Sta-Rite 166
 Heater Connector Pipes 169
 Heater Elements 169, 190
 Heater Element Wrench 219

Heater Parts 389

Heater Parts, Common

Pentair/Sta-Rite 165, 166
 Raypak 162, 164
 Laars 161
 Spa 169, 190
 Heat Pumps 168
 Heat Sinks 169
 Hi Build Paint 224
 Hi-E2 Heaters 159
 High Limits, Spa 190
 Hinge Assembly, DuraFlex 95
 Hinged Ladder Anchor 84
 Hooks, Rope 260

Hose

Discharge & Accessories 79
 Garden 80
 Radiator 65
 Suction 78
 Vacuum 64
 Hose Accessories 65, 79-80
 Hose Bibs 212
 Hose Clamps 79
 Hose & Cord Reel 220
 Hose Couplings 79-80
 Hose Hangers 65, 73, 80
 Hose Nozzles 80
 Hose Reels 65, 220
 Hose Strainers 79
 Hose Washers 79-80
 H-Series Heaters 166-167
 Hydro Air Fittings 193, 210
 Hydroquest 30
 HydroQuip Spa Packs 186
 Hydrostatic Relief Valves 196
 Hydrostatic Valve Wrench 219
 Hydrotherapy Units 193

I

Impeller Wedge 219
 Impeller Wrench 219
 Impeller, Letro 293
 Impellers 371-387
 Inflatables 265-267

Inflatable Test Plugs 217
 In Ground Liners 284
 In Ground Safety Fence 256
 Inlet Fittings 189, 191-194
 In-Line Filters 122, 125
 In-Pool Steps 280-281
 Insert Poly Fittings 208
 Inside Pipe Couplings 216
 Inside Pipe Cutter 218
 Insider Eyeball Fittings 191
 Insider Pipe Extenders 216
 Insider Return fittings 192
 Intelliflo, Pentair 143
 Intellitouch 181
 Intermatic Timers 180
 Iron Test Kit 48

J

Jack's Lube 235
 Jack's Magic 1, 28

Jacuzzi

A/G Pump/Filter Systems ... 278
 Baskets 202, 448, 451
 Filters 113-114, 124, 278
 Go-Kit for Magnum 150
 Hydrotherapy Fitting 193
 Main Drains / Grates 195, 197
 Pumps 142-143
 Replacement Cartridges 127
 Replacement Grids 118
 Seals 158
 Skimmers 199, 201
 Spa Fittings 189
 Sump Pumps 77
 Weirs 202

Jandy

Aqua Garden 252
 Baskets 448
 Chlorine Generators 2, 35
 Cleaners, Ray-Vac 58
Cleaner Parts 297-302
 Controls 5, 181-182
 Filters 114, 122
Filter Parts, Cartridge 333
Filter Parts, D.E. 345
 Heaters 159-161
Heater Parts 400-409
 Heat Pumps 168
 Leaf Baggers 71
 Lights 6, 175
 Light Bulbs 178
 Pumps 135
Pump Parts 375-377
 Ray-Vac Replacement Parts . 59
 Replacement Cartridges 127
 Seals 158

Jandy (Cont.)
 Stain Master Acid Applicator . 72
 Valves 213-215
 Jazz Light 175
 Jet Fittings 189, 193
 Jigs, Diving Board 92-93, 96
 Jogger Belts 263
 Junction Boxes 5, 179

K

Kaf-Flex Conduit 179
 Kayak Replacement Liners 274
 Kelley Paint 7, 223
 Kick Boards 263
 King Technology Chemicals .. 23-24
 King Chemical Feeders 40
 King Chlorine Generator 36
 Knee Pads 222
 Kwik Repair Couplings 216

L

Laars Gas Heaters 104, 159-161
 Laars Heater Covers 291
 Labels, Plumbing 221
 Ladders, Above Ground 280-281
 Ladders, In Ground 81
 Ladder Bolts 84
 Ladder Bumpers 84
 Ladder Tread Non-Skid Tape 281
 Ladder Treads 84, 281
 Ladder Tread, Sylvan 194
 LaMotte Test Strips 50
 Lanyards 261
 Latex Gloves 222
 Latex Multicoat 228
 Laser Filter Systems 113, 278
 Leaf Baggers 71
 Leaf Rakes & Skimmers 70-71
 Leaf Traps 69
 Leak Detectors 220
 Len Gordon 184
 Lenox Saws 218
 Lens Gaskets 178
 Lenses, Light 178
 Letro Cleaners 56
 Letro & Polaris Common Parts 293
 Letro Common Parts 57
Letro Legend Parts 303-308
 Lifeguard Accessories 261-262
 Lifeguard Chairs 94, 97-98
 Life Hooks 261
 Life Ring Buoys 261
 Life Vests 263
 Lifts, Handicapped 99
 Light Adapter Rings 177
 Light Bulbs 178

Light Lenses 178
 Light Wedge 177
 Lights, Underwater 172-178, 282
 Lily Pad Skimmers 201
 Liner Hanger 283
 Liner Lock 283
 Liners 274-275, 284
 Liner Accessories 283
 Liner Vacuums 283
 Liner Wall Foam 283
 Liner Pool Base 283
 Lithium Hypochlorite 12, 15, 17
 Little Giant Pumps 76
 Little Giant Water Garden Kit 253
 Little Giant Light Kit 292
 Loop Loc Safety Covers 286
 Lounges, Floating 265-266
 Low NOx Heaters 159, 165
Low Nox Parts (Jandy) 405-408
 Lubricants 23, 43, 235

M

MA Feeders 40
 Magic Lube 235
 Magnetek Motors 153-154
 Magnum Pumps 142
 Main Drains 195-197
 Main Drain Cover for Cleaners ... 61
 M. D. Frames & Grates 196-197
 Main Drain Mats 9
 Main Drain Screws 197
 Main Drain Sumps 195
 Maintenance Kits 8, 71
 Maintenance Pumps 76-77
 Manhole Cover & Gasket 101
 Marble Dust 226
 Marlow Com. Pumps 105-106
 Marlow H & L Strainers 109
 Marlow Pump Seals 158
 Marlow Pump Gaskets 158
 Marlow Pump Strainers 451-452
 Masking Tape 220, 225
 Masks, Swimming 264
 Mattresses 265-266
 Matrix Pumps 3
 Max-E-Glass Pumps 148
 Max-E-Therm Heaters 166
 Maxim Basket 446
 Maxim Pump System 279
 Maxim Pump Seals 158
 MaxiPolish 20
 Mean Green 14
 Mer-Made H & L Strainers 109
 Mesh Safety Covers 286
 Message Tile 246-247
 MetaMax Plaster Additive 228
 Meteor Multiport Valve 120

Meteor Sand Filter System 279
 Meyco Cover Accessories 286
 Miami Filter Tanks 101-102
 Mighty Vac 283
 Mineral Purifiers 21-22, 24
 MiniMax Heater Covers 291
 MiniMax NT Heaters 165
MiniMax Heater Parts 389
 MiniMizer Algae Preventative 23
 Mission Couplings 216
 Modular Media Filter 125
 Modulating Float Valve 132
 Molly Brown 265
 Monopersulfate Shock 12
 Monopersulfate Test Kit 48, 51
 Mortex Joint 239
 Mosaic Pool Tile 245
 Motor Repair Parts 154-155
 Motors, Commercial Repl. 156
 Motors, Replacement 151-156
 Mouse Away 291
 Mr. Sticky Epoxy Glue 234
 Multicoat Scratch Coat 228
 Multiport Vlv. 100-110, 120-121, 113
 Multiport Parts 150
 Muriatic Acid 13
 Muriatic Acid Applicator 72

N

Natural Chemistry 1, 27-28
 Nature 2 Products 21-22
 Nautilus D.E. Filters 116-117
Nautilus Parts 348-350
 Navigator 56
 NDS Drain 239
 New Water System 23
 Niches 173-177
 Niche Potting Compound 179
Nipples
 Brass 209
 PVC 207
 Nitelighter A/G Lighting 282
 Non-Chlorine Sanitizers 20-22, 24
 Non-Chlor Shock 12, 17, 19-21, 23, 28
 Non-Skid Additive 224
 Northstar Baskets 447
 Northstar Pumps 136
 Northstar Pump Parts 369
 Northstar Motors 155
 Nose Clips 264
 Novagard Silicone 230
 Nozzles 80

O

Observation Platforms 98
 Odyssey Solar Reel 270

Oil Heaters 159
 Olympic Wall Skimmer 201
 Olympic Skimmer Basket 202
 Olympic Skimmer Faceplate 291
 Olympic, Kelley Paint 223
 Omni Chemicals 12, 17-20
 Omni Chemical Feeders 40
 One Meter Dive Stands 95-96
 On-Guard Winter Kits 285
 Open Test Plugs 217
 O-Ring Kits 59, 122, 124, 150, 221
 ORP Controllers 38
 ORP Testers 3, 48
 Ortega Check Valves 215
 Outdoor Clocks & Therm. 255
 Ozonators 33-34

P

Pace Clocks 87
 Paint 223-225
 Paint Equipment 225
 Paragon Dive Stands 96
 Paragon Lifeguard Chairs 97-98
 Paragon Starting Platforms 88
 Paralon 2 Paint 223
 Patch Kits 233
 Patio Accessories 255-256
 Patio Tones 223
 Pavers, Brick 250-251

Pentair

 Chemical Feeders 41
 Chlorine Gen. (Intellichlor) 37
 Commercial Fiberglass Pole 8
 Commercial Filters 102
 Commercial Pumps 106-107
 Controls 180
 Cleaners, Letro 56
Cleaner Parts 295
 Deck Jets 253
 Eyeball Fittings 191
 Filters 102, 116-117, 125
 Grates 196
 Hand Skimmers 70
 Heaters 136, 165-166
Heater Parts 389
 Junction Box 179
 Letro & Polaris Comn. Parts . 293
 Lights 172-174, 176-177
 Light Lenses 178
 Main Drains 195, 197
 Main Drain & Grate Screws .. 197
 Motors, Replacement 153, 156
 Pumps 106-108, 144-149
Pump Parts 369
 Repl. Cartridges 126-128
 Skimmers 199, 201
 Skimmer Baskets ... 202, 449, 453

Pentair (Cont.)

 Skimmer Faceplates 202
 Skimmer Lids 202
Slide Valves Parts 445
 Vac Heads 68
 Valves 116, 121, 214-215
 Venture Jet Nozzle 193
Filter Parts, Cartridge 329
Filter Parts, D.E. 337
Filter Parts, Sand 353
 Perflex D.E. Filters 115, 277
 Perflex D.E. Filter Ro Kits 132
 Perform-Max Feeder 40
 Peristaltic Feeders 42-43
 Permatex Products ... 209, 233-235
 Peroxide Shock 15, 20
 Pet Cocks 209
 pH Meter 3, 48
 Phosfree Products 27
 Photon Generators 170
 Pinnacle Go Kit 150
 Pinnacle Pumps 147
 Pinnacle Seals 158
 Pipe, PVC 203
 Pipe, Flex 203
 Pipe Cutters 218
 Pipe Extenders 216
 Pipe Hangers 220
 Pipe Saw 218
 Pipe Taps 219
 Plaster 226-227
 Plastic Deck Anchors 85
 Plastic Hose Couplings 79
 Pliers 219
 Plugs 209, 217
 Plugs, Ear 264
 Plugs, Purge 290
 Plugs, Throttling 193
 Plugs, Winter 290
 Plumbing Labels 221
 Pocket Mask 262
 Pocket Testers 48
 Polaris Cleaners 60-62
 Polaris Control System 181
 Pole Accessories 73
 Poles 72
 Poles, Rescue 261
 PolyClear Chemicals 20
 Poly Insert Fittings 208
 Poly Pipe 203
 Poly Tubing 45
 Pond Test Kits 51
 Pool Alarms 257-258
 Pool Base 283
 Pool Cove 283
 Pool Cover Pumps 76-77
 Pool Covers 286-288
 Pool Entry Steps 280-281
 Pool-Eye Alarms 258

PoolFix 232
 Pool Frog Chlorine Generator 36
 Pool Kits, Above Ground ... 272-273
 Pool Mix 226
 Pool Patch 229
 Pool Patch Vinyl 233
 Pool Perfect 27
 Pool Plaster 226-228
 Pool Putty 233
 Pool Repair Products 229-234
 Pool Shark Cleaners 53
 Pool Signs 259
 Pool/Spa Controls 181-184
 Pool Tile 243-247
 Portable Lifeguard Chairs 98
 Portable Vacuum Systems 63
 Potting Compound 179
 Powerflo Go Kit 150
 Powerflo Pumps 3,137
 Powerflo Pumps Baskets .. 447-448
 Powerflo Pump Seals 158
 Powerflo Motors 155
 Power Vac Cleaner 63
 Poxolon Paint 223
 Poxoprime Primer 223
 PPG Products 12,31
 Praher Multiport Valves 121
 Praher Plumbing Valves ... 212-213
Praher Multiport Valve Parts . 444
 Precision Timers 180
 Premix 283
 Pressure Gauges 133
 Pressure Patch & Seal 233
 Pressure Test Rigs 217
 Prevent Laser System 257
 Primers, Paint 223-224
 Primers, PVC 210
 Pro-Grid D.E. Filter 115
 Pro-Grid Multiport 120
Pro-Grid Filter Parts 341-342
 ProPak Spa Packs 185
 Pro Series Sand Filters 112
 Pro Series Multiports 120
 Pro Series RO Kit 132
 Pro Series A.G. Systems 276
 Pro Series Parts 355-357
 Protect-A-Pool Fence 256
 Pro Vacs, Rainbow (Pentair) 66
 Pull Buoys 263
 Pumice Cleaner 14
 Pumice Stones 73,80
 Pump and Valve Repair Kits 150
 Pump Cart 63
 Pump Lid Wrench 219
 Pump Seals & Gaskets 158
Pumps, Filter 105-108,135-149
 Aqua Flo 106,135
 Commercial 105-108
 Hayward 136-139

Pumps, Filter (Cont.)
 Jandy 135
 Jacuzzi 141-143
 Pentair 143-149
 Sta-Rite (Pentair) 148-149
 Pumps, Maintenance 10,76-77
 Purge Plugs 290
Push-Pull Valves 120-121
 Anthony Rep. Parts 150
 American Kit 116
 Pentair Kit 116
 Triton Kit 110
PVC
 Cement 210
 Conduit 179
 Fittings 173-176
 Fitting Extenders 216
 Light Niches 174,177
 Pipe 203
 Pipe Cutters 218
 Rail Goods 81-83
 Repair Couplings 216
 Saws 218
 Saddle Tee Clamps 133
 Suction Hose, Coupled 78
 Unions 210-215
 Valves 211-215
 Wire Saw 218

Q

Quaker Drain & Joint 238,240
 Quanta (Jac. Whirlpool Cart.) ... 130
 Quantum Replacement Cart. ... 126
 Quantum RO Kit 132
 Quartz Light Bulbs 178
 Quick Clear Shock 17
 Quick Coupling - Garden Hose .. 80
 Quick Disconnect Fittings 79
 Quick Fix Repair Couplings 216
 Quickset Paragon Starting Plat. 88
 Quickset Platform Anchor 88
 Quick Pool Patch 234
 Quick Set Leak Repair 233
 Q-Vac Liner Vacuum 283

R

Racing Lanes 86-87
 Radiator Hose 65
 Rail Goods 3, 81-85
 Rainsuits 222
 Rabbit 8, 218
 Ramp Access to Water 99
 Ramuc Paint 7, 224
 Ramuc Clean and Prep 224
 Ranger A/G Cleaner 55

Raypak

Commercial Heaters 104
 Common Parts 162,164
 Digital Electronic Heaters 162
 Electric Spa Heaters 169
 Gas Heaters 104,162-164
 Heat Pump 168
Heater Parts 419-426
 Ray-Vac Cleaner 58
 Ray-Vac Common Rep. Parts ... 59
Ray-Vac Parts 297-302
 Reagents 46-51
 Rebuild Kits 32,59,61-62,150
 Recessed Steps 83
 Reciprocating Saw Blades 218
 Rector Seal 210,220, 235
 Reel, Hose & Cord 65
 Reel Systems 270-271
 Regenex D.E. Filter 115
 Rendevous Spa Products 26
 Repair Couplings 65, 216
 Repair Tape 270
 Replacement Zodiac Cartridges . 22
 Replacement Cartridges ... 126-131
 Repl. Cart. Swimclear 123
 Repl. Cart. Jacuzzi 124
 Repl. Cart. Clean & Clear 125
 Replacement Grids 118-119
 Repl. Grids Jacuzzi Earthwks . 114
 Repl. Grids Hayward Pro-Grid .. 115
 Repl. Grids Pentair FNS 116
 Repl. Grids Pentair Nautilus 117
 Replacement Liners ... 274-275, 284
 Rescue Can 261
 Rescue Poles 261
 Rescue Tubes 261
 Resuscitation Mask 262
 Retrofit Brick Coping 249
 Return Fittings 191-193
 Ring Buoy 261
 Ring Rails 83
 Rocky's Solar Roller 270
 RO Kits 132
 Rola Chem Feeders 43
 Rola Chem Flowmeters 134
 Roller Covers 225
 Rope 260
 Rope Anchors 194
 Rope Eyes 194, 260
 Rope Floats 260
 Rope Hooks 260
 Rope Kits 260
 RTV Silicone 230, 235
 Rubber Based Paint(Syn)7,224-225
 Rubber Boots 222
 Rubber Fulcrums 93,96
 Rubber Test Plugs 217
 Rule Pump 77
 Rules, Pool (signs) 259

- Rust Stone 73
- S**
- Saddle Clamps 133
- Safe-T-Pool Steps 81
- Safety Covers 286
- Safety Cover Anchors 286
- Safety Enclosures 179
- Safety Equipment 261-262
- Safety Fence 256
- Safety Float Line 260
- Safety Goggles 222
- Safety Grip Coping 248
- Safety Alarms 257-258
- SAL Light 172
- Salt 13
- Salt Chlorine Generators 35-37
- Salt Generator Accessories 37
- SAM Light 172
- Sand Dollar Filters 111
- Sand Filters 100-102,110-113**
- Astral 100
- Hayward 112-113
- Jacuzzi 113
- Miami 101-102
- Pentair 102,110-111
- Pump/Filter Systems 278-279
- Sand Filter Parts 353**
- Sand & Gravel 14
- Sand Trap Sand Filters 113
- Sand Trap System 221
- Sand Vac 221
- Sau-Sea Paint 225
- Saws 218
- Scamp Port-A-Vac 63
- Schmear 233
- Scoops 14, 221
- Scotch Tread 256
- Scratch Kote 228
- Screwdriver 219
- Scrubbers 74, 220,230
- Scrubbers, Sweep Hose 314-325
- Scum Removers 26,188
- Sea-Klear 1,29,292
- Sealants 209-210,230-235
- Seals, Pump 158
- Sentinel Pool Alarms 257
- Separation Tanks 115,117
- Sequa Sol 25
- Service Pumps 77-78
- Sheer Descent 252
- Sheet Tile 243
- Sherlok Cartridge Filters 124,127
- Shower Valves 212
- Sight Glasses 133
- Signs, Pool 259
- Silicone Adhesive 230
- Silicone Caulk 230
- Silicone Lube 23,235
- Skimmers, Concrete 198-199
- Skimmers, Hand 70
- Skimmers, Vinyl 200-201
- Skimmer Weirs 201-202
- Skim Vacs 198, 200-201
- Slide Accessories 90
- Slide Rock Slide 91
- Slides 90-91
- Slush Boots 222
- Smart Cart 283
- Smart Q Vac 283
- Snorkels 264
- Soda Ash 13
- Sodium Bicarb 13
- Sodium Bisulfate 13
- Sodium Bromide 13
- Sodium Thiosulfate 13
- Solar Blankets 269
- Solar Reels 270-271
- Solid Safety Covers 286
- Solvents 223-224
- Sonneborn Sealant 231
- Spa**
- Accessories 187-189
- Blanket, Bubble 269
- Blanket, Foam 188
- Blowers 187
- Cartridges 129-131
- Chemicals 19, 26
- Controls 182,184
- Covers, Deluxe 188
- Eclipse Ozone (Del) 34
- Fittings 189
- Fragrances 26
- Frog 24, 36
- Heaters 103,159,166,169
- Jets 189
- Ladder 188
- Lights 6,173-175
- Packs 185-186
- Pillows 188
- Rail 188
- Replacement Parts 190
- Skimmers 201
- Spa Wand 188
- Spanner Wrench 79, 219
- Spectrum (SAM) Light 172
- Spee-D Drain 239
- Spine Boards 262
- Spine Board Straps 262
- Splash & Slam 89
- Spongex Kick Boards 263
- Spray Adhesives 235,247,253,283
- Spray Inlets 193
- Spray Paint 225
- Spring Loaded Check Valves 215
- Squeegees 75
- S. S. Hose Clamps 79
- Stain Master 72
- Stair Rails 82
- Stanchions 85
- Star-Clear Cartridge Filter .. 122,277
- Star-Clear Mineral Systems 123
- Star-Clear Replacement Cart. .. 126
- Sta-Rite by Pentair**
- Cleaners 58
- Commercial Pumps 108
- Common Parts 166
- Go Kit 150
- Filters 102,107
- Heaters 166
- Lights, Bulbs, Lenses 176-178
- Main Drains 197
- Motors 152
- Pumps 148-149
- Pump Parts 369**
- Replacment D.E. Grids .. 118-119
- Replacement Cartridges 128
- RO Kit 132
- Seals 158
- Skimmers 199
- Skimmer Lids 202
- Valves 121
- Starting Platforms 88
- Steel Meter Dive Stand 96
- Stegmeier Deck Forms 240
- Stenner Chlorinators 43
- Steps 81,83, 280
- Stingle Switch 258
- Stop Leak 188
- Storage Reels 65,86-87
- Storage Vats 44
- Strainers, Hair & Lint 109
- Strainer, Hose 79
- Strap Wrench 31, 219
- Submersible Pumps 76-77
- Suction Hose 78
- Sump Pumps 76-77
- Sumps, Commercial 77
- Sumps, Main Drain 195-196
- Sunglow Lights 177
- Sunlites 176,178
- Sunlite/Sunburst Lens 176
- SunSaver Light Bulbs 178
- Super Pumps 136
- Super Pump Go Kit 150
- Super Pump Motors 151-152
- Super Pump Parts 372-373**
- Super Pump Baskets 447
- Supertensioner Reel 86
- Sure Traction Epoxy 225
- Swan Chlorinator 39
- Swan Ladder Treads 84
- Swan Lifeguard Chair 97
- Swan Lifeguard Chair Parts 98
- Swim Caps 264

Swim Clear Filter 123
Swim Clear Filter Parts 331
 Swimfree Chemicals 30
 Swim Jet 189,193
 Swimline Goggles/Masks/Snkl 264
 Swimming Aids 263
 Swim 'N Dunk 89
 Swim 'N Spike 89
 Swim Pure 22,123
Swimquip
 Eyeball Fittings 191
 Floor Return 193
 D.E. Grids 118
 Lights 177
 Light Bulbs 178
 Light Gaskets 178
 Light Lenses 178
 Ladder Tread 84
 Lifeguard Repl. Parts 98
 Main Drains 195
 Replacement Cartridges 128
 Replacement Grates 197
 Seals 158
 Skimmers 199
 Skimmer Lids 202
 Valves 121
 Wall Inlets 192
 Weirs 202
 Swim Teacher 263
 Swim Vests 263
 Swing Check Valves 7, 215
 Sylvan Parts 194
 Synergy, Omni 20
 Syphon Drum Pump 13,221

T

Tagelus Filters 111
 Tagelus Common Parts 111
 Tagelus RO Kit 132
 Tagelus Valve 121
Tagelus Parts 358-361
Tagelus Valve Parts 442
Tape
 Duct 220, 225
 Electrical 220
 Masking 220,225
 Teflon 235
 Taps 179, 219
 Taylor Test Kits 46-49
 Taylor Test Reagents 47
 TDS Meters 3, 48
 Teflon Tape 235
 Telescopic Poles 8,72
 Tension Reels 86-87
 Testers, Digital 3, 48
 Test Kits & Reagents 48-51
 Test Plugs 217

Test Strips 1,19,26,49-51,71
 Test Tablets 50
 Thermal Dome Spa Covers 188
Thermometers 8,52,71,255
 Pool & Spa 8,52,71
 Outdoor 255
 Thermostats, Spa 190
 Thermowells 190
 The Step Stuff 28
 The Stuff 28
 Thorite 229
 Thorogrip 229
 Thoro Products 229
 Thoroseal 229
 Threaded Plugs 209
 Three Meter Dive Stand 95
 Throttling Plugs 193
 Throw Bag 261
 Tiger Shark Cleaner 53
 Tile 243-247
 Tile Brush 74
 Tile Grout 228-230
 Tile & Plaster Repair 228
 Timer Clocks 180
 Tire Valve 217
 Tools 8,191,218-219
 Towel Hugger 255
 Toys 265-268
 Transformers 179
 Trash Pumps 10,77-78
 Treads, Replacement 84
 Triac A/G Replacement Liners 275
 Triac Slides 91
 Triac Kayak Liners 274
 Tri-Clops Filters 124
 Tri-Clops RO Kit 132
 Tri-Fold Saw 218
 Trident Pumps 77
 Triton Filters 110
 Triton Laterals 111
 Trowels 220
 True Union Ball Valves 212
 TSP 14
 Tub of Gold 188
 Tubing Cutter 218
 Tubing, Poly & Vinyl 45
Tune-Up Kits
 Polaris 61
 Letro (Pentair) 56,57,293
 Ray Vac (Jandy) 58
 Turbo Turtle 255
 Turtle (Polaris) Cleaner 60
 Typhoon Utility Pump 77

U

U-Frame Dive Stands 93
 Ultra Flow Pumps 147

Ultra Flow Pump Parts 370-371

Ultralite Filter Base 132
 Ultra Max Cleaners 54
 Ultra-Safe Acid 13
 Umbrella, Guard Chair 94,97,98
 Umbrella 261
Underwater Lighting 172-179
 Amerlite 172-173
 Fiberstars 254
 Fiberworks 170-171
 Hayward 174-175
 Paragon 172
 Pentair/Sta-Rite 176-177
 Smart Pool Nitelighter 282
 Transformers 179
 Unions 7,35,114,149, **210**
 Uranine Dye 220
 Utility Knife 218
 Utility Pumps 77-78
 Utility, Compact Ball Valves 213

V

Vac Heads, Commercial 66
 Vac-Heads, Residential 67-69
 Vac Head Parts 69
 Vac Hose 64
 Vac Hose Accessories 65
 Vac Hose Reel 65
 Vac-Mate (Rainbow) 188
 Vacuum Breaker 212
 Vacuum Fitting 192
 Vacuum Gauges 133
 Valterra Valves 212
Valves 211-215
 Ball Valves 212-213
 Check Valves 215
 Compool 214
 Gate Valves 212
 Jandy Valves 214-215
 Multiport Valves 120-121
 Multiport GO Kits 150
Multiport Valve Parts ... 443-444
 Push-Pull 110,116,120-121
 Push Pull Go Kits 150
Push Pull Valve Parts 445
 Shower Valves 212
 Wafer Valves 211-212
 Vanson Chemicals 292
 Vats, Chlorine 44
 Velcro Strap 220
 Venting for Heaters 160,163,165
 Vermiculite 283
 Versa Heaters 163-164
 Vertical Grids 119
Vests 263
 Vinyl 263
 Yoke Type, Orange 263

Vinyl Depth Marker 247
 Vinyl Hose 65
 Vinyl Palm Gloves 222
 Vinyl Patch Kits 233
 Vinyl Tubing 45
 Volleyball Game 89, 268
 Vulkem Products 231

W

Wafer Valves 211-212
 Wall Adhesive 283
 Wall Brush 74
 Wall Foam 283
 Wall Inlet Fittings 192
 Water Basketball 89, 268
 Waterfalls 93,252-254
 Water Garden Kits 253
 Water Level Control 193
 Water Link Express 50
 Water Logs 267
 Waterpik Deck Jets 253
 Waterpik Skimmer 201
 Watermatic Valve 32
 Waterplug 229
 Water Polo Game 268
 Water Slides 90-91
 Water Tubes 289
 Water Volleyball 89, 268
 Water Wizard Pump 76
 WD-40 235
 Weather-Out Covers 291
 Wedding Cake Steps 280
 Wedges, Anchor 84-85
 Wedge, Light 177
 Weirs, Skimmer 202
 Wet Plug 229
 Wheel Chair Access 99
 Whisperflo Pump 144
 Whistles & Lanyards 261
 White Cement 226, 228
 White Sand 14
 Whitewater Slide 91
 Wild Ride Slide 91
 WingMaster Tool 194,219,291
 Winter Plugs 217
 Winter Products 285-292
 Wire Saw 218
 Wood Poles 75
 Work Apparel 222
 Work Boots 222
 Work Gloves 222
 Wrenches 12,13,23,31,86-87,
 110-111,113,148,189,191,194,219

Z

Zeron Paint 223
 Zero Phos 29
 Z-Flex Heater Venting 166
 Ziffy Clock 255
 Ziffy Board 263
 Zodiac Pool Care 21,36,55
 Zodiac Tile 243
 Zoomerang Slide 91

Hatchik Supply Co.

5260 Port Royal Road
 Springfield, VA 22151

(703) 321-7699 Phone
 (703) 321-8478 Fax

(800) 321-8479 Fax Toll Free



!!! INCREASE YOUR PROFIT !!!

As business men and women, we should all be in the hunt for new ways to make more dollars. You and all of your employees should be informed and made aware of what's out there to help introduce and sell these products.

The following, some old but most new items, should help you increase your sales and, hence, your profits:

Chemicals



GLB Cell Saver 1 Quart Bottle (12 x 1 Qt.)
Keep water sparkling clean and clear, stops metal staining, clears cloudy water, increases efficiency, and reduces phosphates to prolong the life of the Chlorine Generator cell.

ITEM NO.
A5032

GLB Tub Rinse 1 Pint Bottle (12 x 16 Oz.)
Cleans the dirt you can't see, prevents build up that could restrict water flow and damage equipment.

A5033



Layor Care Heavy Calcium Releaser (Gal.)
A releaser of calcium and stains, incredible on the toughest build up, safer than mineral acid, won't etch most surfaces, VOC compliant, won't affect pH levels, tile & substrate safe, easy to use, quick deposit breakdown, acid free.

A2207

Natural Chemistry Stain Free (12 x 1.75 Lb.)
All Natural stain remover, it's like Vitamin C for your pool.

A6546

Natural Chemistry Perfectly Clear 6 in 1 (12 x 1 Qt.)

A6538



Jack's Magic Purifier (24 x 15 Oz. Bag)
Jack's Magic Purifier (15 x 22 Oz. Bag)

A6767
A6769

Environmentally Safe D.E. replacement, 60% greater dirt holding capacity than D.E. Uses less material than other media, longer filtering cycle, provides superior water quality.

Sea-Klear Particle Removal System Kit

2 - Quart/Set
2 - Gallon/Set

A7131
A7134



Sea-Klear Natural Clarifier Tabs - Pool (24 x 2 Tabs)

A7140

Sea-Klear Natural Clarifier Tabs - Spa (24 x 2 Tabs)

A7142

Sea-Klear SKV-U-Q Leak Sealer Quarts

A7720

*Seals minor leaks (water leaks 1-inch per day in a 15,000 gallon pool)
Replaces M5379 Fix-A-Leak.*



Ocean Blue 50/Bottle 3-Way Test Strips, Cl, pH, Tot. Alk.

B1425

Chlorine Generators

Goldline Aqua-Rite Electronic Chlorine Generator

Cell and Cell controller. For up to 40,000 Gallon Pools



ITEM NO.
D3000

Goldline AQL - Plus Control

Aqua Plus simplifies and enhances pool and spa ownership by combining automated control and electronic chlorination into one easy-to-install, easy-to-operate package. For up to 40,000 Gallon Pools

D3001

Goldline AQL - CL Replacement Chlorinator Cell with Flow Switch

Replacement Cell for the Aqua-Rite and the AQL Plus Control

D3003

Jandy AquaPure Chlorine Generator APURE 700 with 16 Foot Cable

For 15,000 Gallon Pools. Made of solid titanium plates coated with precious metals, self cleaning with automatic reversing cycles, detects water flow, temperature and true salinity. LCD display, advanced self diagnostics with audible alarm and service indicator.

D4203

Smartpool ChlorEase

Great for above ground pools and fountains up to 18,000 gallons. Unit hangs on the wall.

D3009

Chlorine Generator Accessories

Chlorine Generators require salt water to make chlorine. Salt in the water creates an electrolysis condition where the water becomes very aggressive towards metals causing corrosion. To combat the situation we offer products similar to those used in the marine industry on boats, sacrificial anodes. The water is attracted more to them than to the other metals in your pool so they degrade instead of your valuable ladders, light rings, metal skimmer baskets, or any other metal that makes contact with your water.

Pool Tool Anti Electrolysis Weight

Keeps skimmer basket in place, bolts permanently inside/outside any skimmer basket stop metal erosion & plastic discoloration due to Electrolysis.



ITEM NO.
V7213

Pool Tool Anti Electrolysis Zinc Anode

Eliminates plaster staining & metal corrosion due to Electrolysis, bolts to ladder or grab rail below the water line.

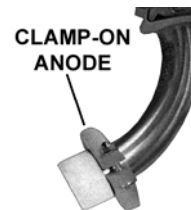

V7216

Intermatic Sacrificial Zinc Anode

Attaches to the ladder itself to protect against corrosion.

G7060

**SALT FOR CHLORINE GENERATORS**

Used in chlorine generation & water softening

Granular

40 Lb. Bag

D5502

(63 Bags/Pallet)

SPECIALTY CHEMICALS FOR POOLS WITH CHLORINE GENERATORS**Cell Saver (For Salt Generators)**

12 x 1 Qt. Btls.

A5032

Jonas Saltique Restore

12x1Qt./Case

A7750

Helps prevent Build-Up of Scale, Oil, and Minerals that can decrease generator cell life.



Water Testing Equipment

Hanna Instruments

pH/ORP/Temp WP Tester HI 98121

Simple to use, highly accurate, floating and waterproof body.

TDS Meter HI 98311

Rugged, floating waterproof casing, dual level display, replaceable graphite electrode.

Phosphate Meter HI 93717

Reagent for Phosphate Meter HI 93717-01

Ph 7.01 SAC (25-20ml.) HI 70007P



ITEM NO.

B1435

B1436

B1437

B1438

B1439

Rail Goods

SAFTRON RAILS

No Bonding or Grounding required! This means no cutting through the deck on replacement jobs. No rusting, pitting and scaling, never get hot & best choice for use in salt water pools. Popular models and sizes currently stocked in white. Others colors may be special ordered.

Figure 4 Grab Rail (White) w/Escutcheons (W-48" x H-32")

Complete Plastic Anchor Socket (Anch-1)

Replacement Wedge w/Screw Nut & Washer

For plastic anchor (Anch-W)



G9063

G7101

G7104

Pumps



HAYWARD POWER-FLO MATRIX PUMPS

The Power-Flo Matrix has been engineered as a uniquely superior above-ground pool pump. With a single push of a button, this truly versatile pump changes from a vertical to a horizontal discharge and back again. Its large profile and integrated styling makes the Power-Flo Matrix a swimming pool pump like no other.



Matrix Pumps with Cord

					ITEM NO.
3/4	HP	Matrix Pump	SP1591	1 1/2"	K3978
1	HP	Matrix Pump	SP1592	1 1/2"	K3979
1 1/2	HP	Matrix Pump	SP1593	1 1/2"	K3980

Matrix Pumps with Timer and Cord

3/4	HP	Matrix Pump	SP1591FT	1 1/2"	K3981
1	HP	Matrix Pump	SP1592FT	1 1/2"	K3982
1 1/2	HP	Matrix Pump	SP1593FT	1 1/2"	K3983
1	HP	Matrix Pump	SP15922S	1 1/2"	K3984

Pumps

HAYWARD TRISTAR™ HIGH PERFORMANCE PUMP

Superior performance, energy efficiency and value. Advanced fluid dynamic design. Three Pump elements to deliver superior flow and energy efficiency plus a revolutionary design for extended motor life. Tristar bases allow it to seamlessly retrofit into existing pool systems.



				Pipe Size	Item No.
1/2	HP	TriStar Pump	SP3205EE	2" / 2 1/2"	K3994
3/4	HP	TriStar Pump	SP3207EE	2" / 2 1/2"	K3985
1	HP	TriStar Pump	SP3210EE	2" / 2 1/2"	K3986
1 1/2	HP	TriStar Pump	SP3215EE	2" / 2 1/2"	K3987
2	HP	TriStar Pump	SP3220EE	2" / 2 1/2"	K3988
3	HP 3P.	TriStar Pump	SP323063EE	2" / 2 1/2"	K3989

PENTAIR SUPERFLO

SuperFlo Pump

The SuperFlo pumps are specifically designed to be the best choice for a variety of inground pools. The SuperFlo features thick walled body parts, a heavy duty 56 square flange motor, and highly engineered hydraulics.

SuperFlo's silent running capability and small footprint allow it to easily drop into a compact equipment pad.

SuperFlo pumps are a direct replacement for Hayward Super Pumps.

				Voltage	Hz	Mfg. No.	Item No.
3/4	HP	Pentair Superflo Pump <i>With adapter</i>	SF-X-3/4A	115/230V	60Hz	340037	K4151
1	HP	Pentair Superflo Pump <i>With adapter</i>	SF-X-1A	115/230V	60Hz	340038	K4153
1 1/2	HP	Pentair Superflo Pump <i>With adapter</i>	SF-X-1.5A	115/230V	60Hz	340039	K4154
2	HP	Pentair Superflo Pump <i>With adapter</i>	SF-X-2A	115/230V	60Hz	340040	K4155

PENTAIR INTELLIFLO

Digital controls allow programming of four different speeds for different jobs. Each setting can range from 400 to 3450 RPMs.



IntelliFlo 4-Speed
IntelliFlo 3-Speed

Mfg. No.	Item No.
011013	K4047
011012	K4048

Replacement Motors

E-MOD REPLACEMENT MOTORS FROM A.O. SMITH

E-MOD motors have an SVRS (Safety Vacuum Release System) built onto the motor that meets ASME Standards for suction entrapment avoidance. This should be an easy sale when a motor needs to be replaced. The average cost of the E-Mod motor is twice the price of a standard motor, so, for an additional \$150 to \$225, your customer would be protected with the very latest anti-entrapment product. Most models are in stock.

Flanged

1 HP

2 HP

Threaded

1 HP

1-1/2 HP



ITEM NO.

K5024M

K5025M

K5034M

K5036M

Energy Efficient Replacement Motors

See page 151 of our Catalog for motor comparisons. These motors are from 8 to 40% more efficient than standard motors. The difference in price pays for itself in one season. If you can't sell the E-Mod, Go with this one !!

Controls

Intermatic Junction Box

Designed for pools, pool-spa combinations & landscape applications, very versatile.

Intermatic Junction Box 2 Light Capacity #PJB2175

Provides safe & reliable connection for up to 2 high or low voltage lights



ITEM NO.

O1206

Intermatic Junction Box for Multiple Fixtures #PJB4175

Provides safe & reliable connection for up to 4 high or low voltage lights

O1167

Polaris EOS Wireless Controller Package



V8006

Polaris EOS 4-Function Single Controller Pool or Spa

V8807

Jandy #7960 One Touch RS24 Spa & Pool Combo Control with Relays

V5816

Designed to blend w/any room decor, can be flush surface mounted, you can 'set it and forget" in-home control, activate multiple features w/the touch of one button, exclusive interface w/JandyColors Pool & Spa Lights and AquaPure Chlorine Generator, Supports up to 32 auxiliary functions, & large, clear screen w/Windows style interface.

Lighting

LED Replacement Bulbs

Fits most existing pool and spa lights. Sells as replacements for burned-out bulbs or as a new way to create color lights; medium base light, 115v & 12v, available in 7 solid colors & 5 multi-light shows. See page 175 for specific products.

5-year warranty - ETL listed. Safety tested and approved
 Working dealer counter display available
 A purchase of 3 bulbs entitles you to a counter display unit at a low cost of \$60
 Change colors using standard light switch
 Uses 90% less electricity than a standard pool light
 What a way to put a new life in pool water at night!!

SAm Fountain Light 120V with a 50 foot Cord #600062

 ITEM NO.
 O1872

UL Listed, world's first submersible color light for swimming pools & spas, delivers white light comparable to the 300W Amerlite, synchronizes w/other SAmS. SAL's and with FIBERworkds PG2000 simple 3-wire connection, great for new installations and replacements.

Hayward Color Logic Light 120 V (Will fit existing Paragon Niches)

Slim profile, an easy-to-install product design, top-of-the-line LED technology, no moving parts, ability to synchronize 2 or more lights, sealed unit eliminates the need for service calls (no bulbs to change), lower energy-operating costs

120V 30' Cord SS (LED)

O3015

120V 50' Cord SS (LED)

O3016

120V 150' Cord SS (LED)

O3017

Jandy White Pool Lights

120 Volt - 500W Jandy White Pool Light w/100' Cord

WPHV500WP100 O2440

12 Volt - 300W Jandy White Pool Light w/100' Cord

WPLV300WP100 O2450

120 Volt - 100W Jandy White Spa Light w/100' Cord

WSHV100WP100 O2460

12 Volt - 100W Jandy White Spa Light w/100' Cord

WSLV100WP100 O2470

 Jandy Plastic Pro Niche Large For Gunite **PLNICLRG**

O2435

 Jandy Plastic Pro Niche Small For Gunite **PLNICSM**

O2436



Valves



Tru-Union Clear Swing Check Valves With Unions

		ITEM NO.
	1-1/2"	S1720C15
	2"	S1720C20
	3"	S1720C30
	4"	S1720C40
KBI Spring Check Valve 1 1/2" Clear with a Single Union		V4373
2" Perma Seal 2 Port Variable Flow Valve w/ 1/2" Knock -Out		V4942
2" Double Union 2 Lb. Teflon Spring Check Valve		V4945
Praher 1- 1/2" Check Valve Double Union 2 Lb. Teflon Spring		V4948



Praher offers many alternatives to OEM multi-port valves for Sand and D.E. filters you can save yourself over 15% by choosing Praher over OEM brand valves.

Paint

RAMUC PAINT

Rubber-based paints are no longer VOC compliant in this area. The new Aqualuster paint is compliant with all state and federal environmental regulations. This is a water-based paint with a beautiful high gloss finish. Spreads 450 sq. ft. per gallon on re-coats.

AQUALUSTER ACRYLIC PAINT

Self Priming Topcoat for Virtually All Types of Coatings and Damp Surfaces

	ITEM NO.		
Brilliant White	#3011	1 Gal. Pail	P6030
Black	#321	1 Gal. Pail	P6032
Dawn Blue	#328	1 Gal. Pail	P6033
Royal Blue	#329	1 Gal. Pail	P6034
Brilliant White	#3011	5 Gal. Pail	P6529
Dawn Blue	#328	5 Gal. Pail	P6530

Topcoats and upgrades existing chlorinated and synthetic rubber systems, water based acrylic paints, and bare concrete or plaster.



Coverage 450 Sq. Ft. on recoats!

CLEAN & PREP SOLUTION

Clean and Prep Solution is used to clean and degrease while simultaneously dissolving mineral deposits, increasing porosity for good adhesion on surfaces prior to painting.

	ITEM NO.
Ramuc Clean & Prep Solution	P1517

Kelley Technical Coatings

Kelly Fusion Plus - Converts Rubber Base Pools to Epoxy

White	1 Gal. Pail 260	Q1079
-------	-----------------	-------

Opticoat - Low VOC Synthetic Rubber Based Paints

White	5 Gal. Pail 280	Q2035
Blue Ice	5 Gal. Pail 282-5	Q2045

Maintenance and Repair

Oreq Xcalibur Pro - Strictly Professional*Designed and manufactured to withstand daily use*

ITEM NO.

Oreq Xcalibur 8' - 16' Telescopic Pole - Tri Cam System F6200**Oreq Xcalibur 8' - 16' Telescopic Pole - Fiberglass** F6202**Skimlite 3 piece Telescopic Outside Lock Pole - 5' to 15'** F6028**Pentair Commercial Fiberglass Pole 12' - NSF Certified** F6036**So. Eastern Brush - Tile Swivel Scrub (Threaded)** F5052**Purity Pool - Red Baron - Rag Bag Leaf Rake 20 x 20 # RBRB** F7046*Empties w/a flip of the wrist, secondary wear panel provides extra durability (protects the bag from snags and abrasion)***Leaf Chaser Leaf Rake 20 x 20 #RBLC** F7044*1/4" open mesh bag picks up leaves and debris easily, secondary wear panel provides extra durability (protects the bag from snags and abrasion)***Ocean Blue "Complete" Gunite Maintenance Kit** F3235*Includes 18" plastic curved wall brush, prof. heavy duty leaf skimmer, flexible vacuum head, chrome plated thermometer, test strips (3-way) and 1 1/2" 40' vac hose w/swivel cuff.***Tools for Service Professionals**

Debris Plugs <i>Keep debris out of your lines. Whether you are laying pipe, shooting a pool, spa, or water feature, this will keep the debris out. Also great for white coating, and they're reusable too.</i>	1-1/2"	EE2015
	2"	EE2020
	3"	EE2030
	4"	EE2040

Pro Plys Wire Strippers *Strips wires, cuts screws, nose pliers* V7219**Electrical Test Kit** *Kit consists of: Manual ranging multimeter, polarity cube, and non-contact voltage detector.* V7229**6-In-1 Multi Tool Screwdriver** *Bit sizes 3/16", 1/4", Flat-Tip, #1 & #2 Phillips, 5/16" & 1/4" nut drivers.* V7031**Screw Holding Screwdriver** *Two types available, 11-1/8" long #2 Phillips or 11-1/8"x 3/16" Flathead. Stop dropping screws, actually holds screw in place* V7033
V7032

Maintenance and Repair

Fish Tape 50' Fiberglass fish tape in winder case - no more rusty fish tapes!

ITEM NO.
V7221

Exploding Garbage Can! - Collapsible Trash Container featuring an internal support spring that "Springs into Action". Heavy duty tear resistant polytuf fabric.

V7701



Pipe Spring Benders - You can cold bend, no heat blankets, fewer PVC fittings.

1/2"

V7712

3/4"

V7713

1"

V7714



Tool Holding Systems

Butt Pouch - Mini

V7715

Butt Pouch - Grande

V7716

Main Drain Mat - seals main drain and prevents pool water from leaking through.

V7202



Aladdin Professional O-Ring Replacement Kits

Aladdin P.R.O. Box 1- Contains 10 each of the most popular small O-rings

S4140

Aladdin P.R.O. Box 3 - Contains 20 complete seal assemblies - common parts are put together to make up seals for most residential pumps.

K6090



Basket Buddies - Fits like a sock over skimmer baskets to trap small debris from going through the basket openings. Prevents closed-type impellers from clogging up with pine needles and bits of leaves, etc...



Regular 5 Pack

ITEM NO.
L1956

Jumbo 3 Pack

L1957

Maintenance and Repair

The Circulator

Another item that is underpriced for the return value. This is an amazing product (one of a kind) that forces returning pool water 360 degrees and as far as 15 feet from the fitting – down, up and to both sides – improves circulation by 1500%. The customer saves, as follows:

1. **Heating:** Pushes top layer of solar heated water to the bottom of the pool and eliminates cold spots. Helps heat pool in less time.
2. **Maintenance:** Acts like an in-floor cleaning system, by helping get dirt back to the filter from the main drain and skimmers.
3. **Chemicals:** Eliminated “dead areas”, making chemicals work more efficiently.
4. **Energy Savings:** Not only on lower heating expense, but, by reducing the time needed to use your pump by 1/3.

The circulator installs in seconds, replacing wall eyeball returns. Can also be installed in some (Swimquip type) floor returns (replaces the return cover).

The Circulator ITEM NO. N1030

The circulator is a real bargain and should pay for itself many times over in the first season. Sold each or by the case with additional discounts!

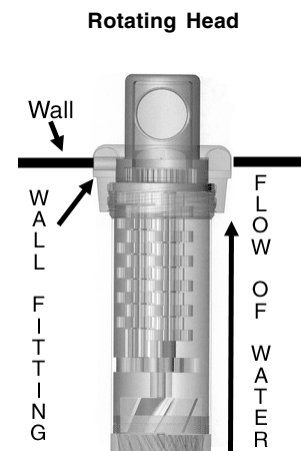

Trash Pumps

Koshin

KOSHIN Gasoline Powered Trash Pump KTH-80X
3" Trash Pump with 8 HP Honda Motor, 354 GPM

ITEM NO.
K1085

**KOSHIN** Submersible Pump

PKS-65011 HD Electric Submersible Trash Pump (2")
110V, 7amp, 75 GPM @ 5' w/ 18' Cord

K1084

FS-10 Float Switch w/10' Cord for Sump Pumps

K1083

FS-20 Float Switch w/20' Cord for Sump Pumps

K1087



Maintenance and Repair

HEAVY DUTY PUMP AND SKIMMER BASKETS

Priced higher than most generic ones but lasts much longer. **Most in Stock.**



Ultra Flo
K9986



K9981
Whisper Flo



K9985
Challenger

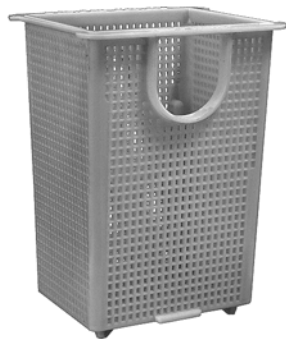

K9980
Hayward Super Pump



K9983
Maxi Glas II & MXE Pro



K3513
Sta Rite 8" Commercial 98 Trap



K9342
Purex Commercial "C" Pump



K6162
B-335 Stainless Steel

Bromine (Tablets)

A disinfectant that destroys & inhibits bacterial & algae growth. Oxidizes organic & nitrogenous waste. A granular non-stabilized chlorine.

	PACKING	ITEM NO.
AllChlor	50 Lb. Pail	A4872
Aquabrome	50 Lb. Pail	A6192
Omni	50 Lb. Pail	A7292

Calcium Hypochlorite (Granular)

A granular non-stabilized chlorine product that destroys bacteria, algae & fungi. Contains 73% available chlorine & is commonly used for shocking.

	24 X 1 Lb. Pail	A2309	
	25 Lb. Pail	A2300	
	50 Lb. Pail	A2310	
	100 Lb. Pail	A2112	(18 Drums/Pallet)

AllChlor	300 x 1 Lb. Bags	A4615
AllChlor	75 x 1 Lb. Bags	A4607

Calcium Hypochlorite (Tablets)

Accu-Tab* Blue SI Tablets w/ Scale Inhibitor

(*For use w/PPG Feeders Only)

PPG - 3" Large Tablets	55 Lb. Pail	A2323
PPG - 3/4" Small Tablets	100 Lb. Drum	A2115

Chlorine (Liquid)

Sodium Hypochlorite is an economic liquid sanitizer, averaging 12.5% strength, pH 13.0

	4 x 1 Gallon Bottles	A6000
--	----------------------	-------

Price Includes \$10 Deposit Charge

	5 Gallon Container	A6005
		V7074

5 Gal. Carboy Wrench

Chlorine (Granular)

Stabilized & typically 56% available chlorine. Its increased rate of dissolution and relatively neutral pH is favored by many pool operators.

AllChlor	25 Lb. Pail	A4203
AllChlor	50 Lb. Pail	A4204
Omni	25 Lb. Pail	A7014
Omni	50 Lb. Pail	A7016

Chlorine (Sticks) - 1/2 Lb.

Stabilized & protected from sunlight. Contains 89% available chlorine & fits many types of feeders.

AllChlor	25 Lb. Pail	A4214
AllChlor	50 Lb. Pail	A4216

Chlorine (Tablets) - Small 1"

Slow dissolving small 1" tablets typically 89% available chlorine. Ideal for floaters & automatic or erosion type feeders.

AllChlor	25 Lb. Pail	A4224
AllChlor	50 Lb. Pail	A4226
Omni	30 Lb. Pail	A7027
Omni	50 Lb. Pail	A7031

Chlorine (Tablets) - Large 3"

Large 3" tablets that are typically 89% available chlorine. Slow dissolving & ideal for erosion feeders, floaters or direct skimmer application.

AllChlor	25 Lb. Pail	A4264
AllChlor	50 Lb. Pail	A4267
Omni	25 Lb. Pail	A7045
Omni	50 Lb. Pail	A7050

Lithium Hypochlorite - 35% Available Chlorine

A granular quick dissolving chlorine product. Ideal for shocking vinyl liner & painted pools.

AllChlor	25 Lb. Pail	A5310
Omni	25 Lb. Pail	A7255
Omni	45 Lb. Pail	A7260

Non Chlorine Shock - Monopersulfate Compounds

Non-chlorine oxygen-based shock compatible w/chlorine & bromine. Doesn't raise chlorine levels & allows swimming 15 minutes after use.

AllChlor	25 Lb. Pail	A5314
AllChlor	50 Lb. Pail	A5316
GLB Oxy-Brite	50 Lb. Pail	A5007



* Some Items Have Discounted Prices On Pallet Quantities *



Acid (muriatic) - Lowers pH

Lowers pH & alkalinity of water and is used for cleaning & etching walls prior to painting

Look for pH
Testing Equipment
on Page 7.

4 x 1 Gallon Bottles

ITEM NO.
A6020
(Pallet -48 Cases)

5 Gallon Container

A6025

Price Includes \$10 Deposit Charge

15 Gallon Container

A6029

Price Includes \$35 Deposit Charge

4 x 1 Gallon Bottles

A6014

Ultra-Safe (For Pool Cleaning)

Acid Sprayer

V7068

Acid Drum Spigot

V7059

Siphon Drum Pump

V7055

Acid Drum Wrench

V7073



Alum - Floccing Agent

Aluminum Sulfate is a good filter coagulant that gathers smaller particles together to be filtered out

Ground 50 Lb. Bag A6071

Calcium Chloride - Raises Calcium Hardness

Used to raise the calcium content of swimming pool water

AllChlor 25 Lb. Pail A4853

50 Lb. Bag A6087

(40 Bags Pallet)

Cyanuric Acid - Conditioner & Stabilizer

Used to protect outdoor pools & spas from chlorine loss due to sunlight degradation

Granular 50 Lb. Drum A6127

(All Drum Weights Are Subject to Change) Granular 55 Lb. Drum A6123

Powder 50 Lb. Drum A6126

Powder 44 Lb. Drum A6128

Salt - Evaporated

Used in chlorine generation & water softening

Granular 40 Lb. Bag D5502

(63 Bags Pallet)

Soda Ash - pH Rise

Powder used to raise the pH of water

50 Lb. Bag A6105

(40 Bags Pallet)

Sodium Bicarbonate - Total Alkalinity

1-1/2 lbs. raises alkalinity 10ppm per 10,000 gallons

50 Lb. Bag A6115

(40 Bags Pallet)

Sodium Bisulfate - pH Reducer (Dry Acid)

2-1/2 lbs. lowers alkalinity 10ppm per 10,000 gallons

50 Lb. Bag A6096

Sodium Bromide

Banks bromine salts

25 Kg. Bag A6060

Sodium Thiosulfate - Chlorine Reducer

1 oz. neutralizes 1 ppm chlorine/bromine per 10,000 gallons

50 Lb. Bag A6098

Hazardous Chemical Sign

X4027



PACKING

ITEM NO.

FILTER MEDIA

D.E. Filter Powder- Diatomaceous Earth 1Lb. used er 8 sq. ft. of filter area.

10 Lb. Bag A6051

25 Lb. Bag A6045

50 Lb. Bag A6040

(4 x 6 Lb.) 24 Lb. Box A6054

Price Break at 30 and 60 Boxes



Purifier - Filter Media Environmentally Acceptable Powder

(D.E. Replacement)

24 x 15 Oz. Bag A6767

15 x 22 Oz. Bag A6769

Aquaperl - Filter Media Environmentally Acceptable Powder

(D.E. Replacement)

1.7 Cu. Ft. Bag A6056

Plastic Chemical EZ Scoop

Each A6048

1 Lb. Hayward D.E. Scoop

Each H6139

2 Qt Scoop: White

Each V7057



V7057

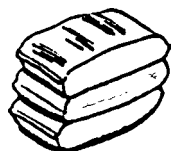

Sand & Gravel For sand filters, 1 cubic foot = Lb. bag

Sand, 45-55 mm

50 Lb. Bag H8110

Gravel, 1/4-1/8"

50 Lb. Bag H8089

Z Media - Filter Media 1-25 Lb. bag replaces 50 Lbs. of sand

25 Lb. Bag A6075

80 Bags

CLEANING PRODUCTS

FOR THE Toughest CLEANING JOBS!
Professional Strength Cleaner/Degreaser

Magic Concentrated all purpose cleaner

4 lb. Btl. V1119

Mean Green Concentrated all purpose cleaner

Quart V1116

Gallon Btl. V1117

Layor Care Heavy calcium release

1 Gal. A2207

Wipe Out Excellent vinyl & tile cleaner - removes grime from many surfaces

12-1 Qt. Btls. A5285

TSP Tri-sodium phosphate

50 Lb. Bag A6129

Ultra-Safe Acid For cleaning

4-1 Gal. Btls. A6014

**METAL CLEANERS & PROTECTORS**

EXCELLENT FOR STAINLESS STEEL GUTTER SYSTEMS



The Stuff For cleaning & removing stains from ladders, rails & other stainless steel products

6-1 Lb. Btl. S1087

40 Lb. Pail S1088

Autosol Metal Polish Paste

3.5 Oz. Tube S1079

35 Oz. Can S1078

Sheila Shine For Cleaning and Coating

1 Gal. Can S1092

HAND CLEANERS

"Fast Orange" Hand cleaner for servicemen - contains pumice

15 Oz. S4078

Gallon Btl. S4079

Cupran Hand cleaner

100 ml. S4118

Scrubs-In-A-Bucket Hand Cleaner towels -Natural citrus scent w/ pumice

4.5 Lb. Jar V1120

Cement Remover For Hands

16 Oz. V1125

Allchlor

PACKING

ITEM NO.

Solid Sticks

(89% Available Chlorine - Stabilized)

8 Oz. Solid Sticks - 5 Lb.

8 Oz. Solid Sticks - 10 Lb.

8 Oz. Solid Sticks - 25 Lb.

8 Oz. Solid Sticks - 50 Lb.



8 x 5 Lb. Btls

3 x 10 Lb. Pails

25 Lb. Pail

50 Lb. Pail

A4210

A4212

A4214

A4216

Small 1" Chlorinating Tablets

(89% Available Chlorine - Stabilized)

1" Tablet Feeder Cartridge - 4 Lb.

(Fits E-Z Chlor & Sylvan)

1" Slow Dissolve 1/2 Oz. Tabs - 5 Lb.

1" Slow Dissolve 1/2 Oz. Tabs - 10 Lb.

1" Slow Dissolve 1/2 Oz. Tabs - 25 Lb.

1" Slow Dissolve 1/2 Oz. Tabs - 50 Lb.



6 x 4 Lb. CartA4218

8 x 5 Lb. Btls

10 x 3 Lb. Pail

25 Lb. Pail

50 Lb. Pail

A4220

A4222

A4224

A4226

Large 3" Chlorinating Tablets

(89% Available Chlorine - Stabilized)

3" Slow Dissolve 7 Oz. Tab - 5.25 Lb.

3" Slow Dissolve 8 Oz. Tab - 10 Lb.

3" Slow Dissolve 7 Oz. Tab - 13.125 Lb.

3" Slow Dissolve 7 Oz. Tab - 25 Lb.

3" Slow Dissolve 7 Oz. Tab - 50 Lb.

3" Slow Dissolve 7 Oz. Tab - 350 Lb.

8 x 5.25 Lb. Btls

3 x 10 Lb. Pails

2 x 13.125 Lb. Pails

25 Lb. Pail

50 Lb. Pail

350 Lb. Pail

A4260

A4880

A4262

A4264

A4267

A4269

Stabilized Chlorinating Granules

(56% Available Chlorine)

Granular Dichlor - 2 Lb. (Nu-Clo)

Granular Dichlor - 5 Lb.

Granular Dichlor - 10 Lb.

Granular Dichlor - 25 Lb.

Granular Dichlor - 50 Lb.

18 x 2 Lb. Btls

8 x 5 Lb. Btls

3 x 10 Lb. Pails

25 Lb. Pail

50 Lb. Pail

A4205

A4201

A4202

A4203

A4204

Oxidizers (shock treatments)

Peroxide Shock

(Dichloro Formula)

Dura Shock - 1 Lb. Bag

Dura Shock - 1 Lb. Bag

(35% Granular Dichloro)

Dura Chlor - 25 Lb.

Dura Chlor - 50 Lb.

(Calcium Hypochlorite)

Cal Hypo Shock - 1 Lb. Bag

Cal Hypo Shock - 1 Lb. Bag

Cal Hypo Shock - 1 Lb. Bag

(Lithium Hypochlorite)

Lithium Hypo Shock - 1 Lb. Bag

Lithium Hypo Shock - 2 Lb. Bottle

Lithium Hypo Shock - 25 Lb. Pail

4 x 1 Gal. Bottles

12 x 1 Lb. Bag (Box)

75 x 1 Lb. Bag (Box)

25 Lb. Pail

50 Lb. Pail

12 x 1 Lb. Bag (Box)

75 x 1 Lb. Bag (Drum)

300 x 1 Lb. Bag (Drum)

12 x 1 Lb. Bag (Box)

16 x 2 Lb. Btls

25 Lb. Pail

12 x 1 Lb. Bag (Box)

8 x 4 Lb. Btls

25 Lb. Pail

50 Lb. Pail

A4603

A4000

A4001

A4020

A4021

A4605

A4607

A4615

A4004

A4006

A5310

A4604

A5312

A5314

A5316

	PACKING	ITEM NO.
Brominating Tablets		
Bromine Mini Tablets - 1.5 Lb.	16 x 1.5 Lb. Pails	A5304
Bromine Mini Tablets - 3.5 Lb.	8 x 3.5 Lb. Pails	A4868
Bromine Mini Tablets - 25 Lb.	25 Lb. Pail	A4870
Bromine Mini Tablets - 50 Lb.	50 Lb. Pail	A4872
Bromine Spa Pak - Individual CR Wrap	36/Case	A4902+
Bromine Spa Pak - 6 Paks per Bucket	8 x 6 Pak Pails	A4904+
Balancers		
<i>(Sodium Bicarb)</i>		
Total Alkalinity - 4 Lb. Bag	12 x 4 Lb. Bag (Box)	A4866
Total Alkalinity - 4 Lb.	8 x 4 Lb. Btls	A4608
Total Alkalinity - 10 Lb.	3 x 10 Lb. Pails	A4610
<i>(Soda Ash)</i>		
pH Increaser - 3 Lb.	12 x 3 Lb. Btls	A4700
pH Increaser - 4 Lb. Bag	12 x 4 Lb. Bag (Box)	A4862
pH Increaser - 6 Lb.	8 x 6 Lb. Btls	A4702
pH Increaser - 10 Lb.	3 x 10 Lb. Pails	A4703
<i>(Sodium Bisulfate)</i>		
pH Decreaser - 3 Lb.	18 x 3 Lb. Btls	A4725
pH Decreaser - 6 Lb.	8 x 6 Lb. Btls	A4730
<i>(Flake)</i>		
Calcium Hardness - 4 Lb. Bag	12 x 4 Lb. Bag (Box)	A4864
Calcium Hardness - 10 Lb.	3 x 10 Lb. Pails	A4850
Calcium Hardness - 25 Lb.	25 Lb. Pail	A4853
<i>(Water Conditioner/Stabilizer)</i>		
Conditioner - 1 Lb.	12 x 1 Lb. Bag (Box)	A4303
Conditioner - 4 Lb.	12 x 4 Lb. Bag (Box)	A4306
Conditioner - 4 Lb.	8 x 4 Lb. Btls	A4304
Conditioner - 25 Lb.	25 Lb. Pail	A4305
Accessory Chemicals		
Dechlor - 3 Lb. <i>(Kills Chlorine)</i>	12 x 3 Lb. Btls	A4620
Sparkle Conquest - Quart <i>(Concentrated Sequestrant)</i>	18 x Qt. Btls	A4302
Stain Preventer - Quart	18 x Qt. Btls	A4501
Clarifier - Quart <i>(2 Oz. per 5,000 Gal.)</i>	18 x Qt. Btls	A4401
Super Clarifier - Quart <i>(1 Oz. per 5,000 Gal.)</i>	18 x Qt. Btls	A4851
Flock (Alum)	8 x 5 Lb. Btls	A4316
Maxi Flock (Liquid)	18 x Qt. Btls	A4314
Anti Phos	18 x Qt. Btls	A4858
Filter Cleaner	18 x 2.5 Lb. Btls	A4312
Cover Cleaner	18 x Qt. Btls	A4310
Algaecides		
<i>(Quaternary Compound)</i>		
10% Algaecide - Quart	18 x Qt. Btls	A4852
50% Algaecide - Quart	18 x Qt. Btls	A4860
<i>(Polymer - No Foam)</i>		
30% Algaecide - Quart	18 x Qt. Btls	A4855
60% Algaecide - Quart	18 x Qt. Btls	A4856
60% Algaecide - Gallon	6 x Gal. Btls	A4857
<i>(Copper Complex - Chelated)</i>		
7% Algaecide - Quart	18 x Qt. Btls	A4854
<i>(.8% Colloidal Silver)</i>		
Silvercide - Quart	18 x Qt. Btls	A5306

+Limited Stock



OMNI
Pool Products

PACKING ITEM NO.

Stabilized Chlorinating Granules (Sodium Dichloro)



Stabilized Granules - 5 Lb.	4 x 5 Lb. Pails	A7002
Stabilized Granules - 8 Lb.	4 x 8 Lb. Pails	A7005
Stabilized Granules - 15 Lb.	2 x 15 Lb. Pails	A7009
Stabilized Granules - 25 Lb.	1 x 25 Lb. Pail	A7014
Stabilized Granules - 50 Lb.	1 x 50 Lb. Pail	A7016

Small 1" Chlorinating Tablets (90% Available Chlorine-Stabilized)



1" Slow Dissolve 1/2 oz. Tab - 5 Lb.	4 x 5 Lb. Pails	A7020
1" Slow Dissolve 1/2 oz. Tab - 15 Lb.	2 x 15 Lb. Pails	A7025
1" Slow Dissolve 1/2 oz. Tab - 30 Lb.	1 x 30 Lb. Pail	A7027
1" Slow Dissolve 1/2 oz. Tab - 50 Lb.	1 x 50 Lb. Pail	A7031
1" Slow Dissolve 1/2 oz. Tab - 4 Lb.	2 x 4 Lb. Cart.	A7345

Large 3" Chlorinating Tablets (90% Available Chlorine-Stabilized)



3" Slow Dissolve 8 oz. Tab - 3.5 Lb.	4 x 3.5 Lb. Pails	A7036
3" Slow Dissolve 8 oz. Tab - 7.5 Lb.	4 x 7.5 Lb. Pails	A7039
3" Slow Dissolve 8 oz. Tab - 16 Lb.	2 x 16 Lb. Pails	A7041
3" Slow Dissolve 8 oz. Tab - 25 Lb.	1 x 25 Lb. Pail	A7045
3" Slow Dissolve 8 oz. Tab - 50 Lb.	1 x 50 Lb. Pail	A7050
3" Slow Dissolve 8 oz. Tab - 90 Lb.	1 x 90 Lb. Drum	A7047*

*Non-Stock Item

Solid Sticks (90% Available Chlorine-Stabilized)

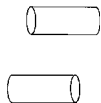

1/2 lb. Solid Stix - 4 Lb.	4 x 4 Lb. Pails	A7060
1/2 lb. Solid Stix - 8 Lb.	4 x 8 Lb. Pails	A7061
1/2 lb. Solid Stix - 18 Lb.	2 x 18 Lb. Pails	A7066
1/2 lb. Solid Stix - 30 Lb.	1 x 30 Lb. Pail	A7068
1/2 lb. Solid Stix - 50 Lb.	1 x 50 Lb. Pail	A7071

Calcium Hypochlorite (47% Available Chlorine)

"Breakout Extra" Calcium Hypochlorite	25 Lb. Pail	A7105
---------------------------------------	-------------	-------

Lithium Hypochlorite (35% Available Chlorine)

Lithium Hypochlorite	25 Lb. Pail	A7255
Lithium Hypochlorite	45 Lb. Pail	A7260



Oxidizers / Shocking Compounds

Breakout Extra- 47% - 1 Lb.	6 x (6 x 1 Lb Cases)	A7087
Breakout Extra- 47% - 1 Lb.	24 x 1 Lb. Boxes	A7103
Breakout Extra - 47%	25 Lb. Pail	A7105
Breakout 35 (Lithium) - 1 Lb.	24 x 1 Lb. Bags	A7092
Breakout 60 - 5 Lb.	4 x 5 Lb. Btls.	A7093
Crystal Clear Multi-Shock	36 x 1 Lb. Bags	A7100
Crystal Clear Multi-Shock	6 x (6 x 1 Lb). Boxes	A7101



Non-Chlorine Shock

Quick Clear - 1 lb.	24 x 1 Lb. Bags	A7096
Quick Clear - 8 lb.	4 x 8 Lb. Btls.	A7082
Quick Clear - 50 lb.	1 x 50 Lb. Pail	A7098

Balancers

Pool Chlorine Stabilizer
(100% Cyanuric Acid)
pH Decreaser

pH Increaser

Total Alkalinity Increaser

Calcium Hardness Increaser

Simplicity Stain & Scale Control
Stain & Scale Control

**Algaecides & Algae Destroyers**

Algae Terminator
(Kills & Controls All Algae Types)

Algaecide "10"
(10% Active Quat)

Algae Preventative
(40% Active Quat)

Multipurpose Algaecide 60
(60% Active Polymer)

Algae Destroyer
(Dichlor)

Algae Kill Concentrate II
(Copper Based)

Super Algae Destroyer
(Plaster Pools Only)

**Accessory Chemicals**

Acid Washing Additive

Simplicity Clear Magic Clarifier

Clear Magic

Clear Magic

Simplicity Cartridge & Filter Cleaner

Cartridge & Filter Cleaner

Simplicity Cover Cleaner

Cover Cleaner Deodorizer

Simplicity Filter Aid

Filter Aids

Simplicity Liquid Floc Plus

Liquid Floc Plus

Simplicity Stain Remover

Stain Remover

Simplicity Surface Cleaner

Surface Cleaner

PACKING
12 x 1.5 Lb Btls.
4 x 6 Lb. Pails

12 x 3 Lb. Btls.

4 x 8 Lb. Pails

12 x 2 Lb. Btls.

4 x 6 Lb. Pails

6 x 4 Lb. Pails

4 x 12 Lb. Pails

2 x 15 Lb. Pails

12 x 1 Qt. Btls.

12 x 1 Qt. Btls.

12 x 1 Qt. Btls.

12 x 1 Qt. Btls.

12 x 1 Qt. Btls.

12 x 1 Qt. Btls.

12 x 1 Qt. Btls.

12 x 1 Qt. Btls.

12 x 1 Qt. Btls.

12 x 1 Qt. Btls.

12 x 1 Qt. Btls.

12 x 1 Qt. Btls.

12 x 1 Qt. Btls.

12 x 2 Lb. Btls.

12 x 2 Lb. Btls.

12 x 1 Pt. Btls.

12 x 1 Qt. Btls.

12 x 2 Lb. Btls.

12 x 2 Lb. Btls.

12 x 2 Lb. Btls.

12 x 1 Qt. Btls.

12 x 1 Qt. Btls.

12 x 1 Qt. Btls.

12 x 1 Qt. Btls.

4 x 1/2 Gal. Btls.

12 x 1 Qt. Btls.

12 x 1 Qt. Btls.

12 x 1 Qt. Btls.

12 x 1 Qt. Btls.

12 x 1 Qt. Btls.

4 x 1.5 Lb. Btls.

4 x 1.5 Lb. Btls.

12 x 1 Qt. Btls.

12 x 1 Qt. Btls.

12 x 2 Lb. Btls.

12 x 2 Lb. Btls.

12 x 12 Oz. Tubes

12 x 12 Oz. Tubes

ITEM NO.

A7075

A7080

A7191

A7195

A7198

A7200

A7204

A7205

A7152

A7153

A7118

A7210

A7127

A7120

A7130

A7132

A7135

A7141

A7126

A7137

A7150+

A7114

A7159+

A7158+

A7108

A7172+

A7115

A7165+

A7116

A7173+

A7113

A7157+

A7112

A7155+

A7117

A7181+

A7181+

A7181+

A7181+

A7181+

A7181+

A7181+

A7181+

A7181+

A7181+

A7181+

A7181+

A7181+

Pool Start-Up Kit

Pool Start-Up Kit for New Pools or Spring Opening

Contains: shock, algaecide, stain control,

water bottle, pool care guide & coupons 6 per Case

6 per Case A7000

**Omni Bromine**

Omni Bromine Tablets

25 Lb. Pail

A7293

Omni Bromine Tablets

50 Lb. Pail

A7292

Aquabrome

Hydrotech Aquabrome Tablets

25 Lb. Pail

A6176











Hydrotech Aquabrome Tablets

50 Lb. Pail

A6192



SPA Essentials™

	PACKING	ITEM NO.
SPA & HOT TUB PRODUCTS		
	Brominating Tablets	12 x 1.5 Lb. Btls. A7507
	Brominating Tablets	4 x 5 Lb. Pails A7505
	Bromine Granular Concentrate <i>(One Step)</i>	12 x 14 Oz. Btls. A7500
	Bromine Granular Concentrate <i>(One Step)</i>	12 x 2 Lb. Btls. A7511
	Chlorinating Concentrate	12 x 2 Lb. Btls. A7523
		4 x 5 Lb. Btls. A7524
	Spa Shock (Non-Chlorine)	12 x 40 Oz. Btls. A7501
	Spa Shock Xtra (Low Chlorine)	12 x 2 Lb. Btls. A7508
	Surface Cleaner	12 x 12 oz. Btls. A7522
	Surface Wipes <i>(60 per box)</i>	4 Box/Case A7520
	Enzyme Cleaner	12 x 1 Pt. Btls. A7529
	Enzyme Cleaner	12 x 1 Qt. Btls. A7537
	pH Decreaser	12 x 22 Oz. Btls. A7533
		12 x 3 Lb. Btls. A7542
	pH Increaser	12 x 18 Oz. Btls. A7528
		12 x 1 Lb. Btls. A7544
	Stain & Scale Control	12 x 1 Pt. Btls. A7530
	Defoamer	12 x 1 Pt. Btls. A7532
	Filter Cleaner & Degreaser	12 x 1 Lb. Btls. A7535
	Water Clarifier	12 x 1 Pt. Btls. A7536
	Total Alkalinity Increaser	12 x 16 Oz. Btls. A7527
		12 x 2 Lb. Btls. A7546
	Calcium Hardness Increaser	12 x 16 Oz. Btls. A7531
Spa pH Anchor	12 x 1 Qt. Btls. A7503	
Spa Startup Kit	2/Cs. A7506	
<i>(Includes: 1 pint Stain & Scale Control, TA Increaser, pH Decreaser, Defoamer, Filter Cleaner, Water Clarifier, 2-2 oz. bags of Spa Shock, quick reference guide video & test strips)</i>		
	Cover Cleaner Spa Cover Wipes	6 x 25 Wipes/Cs. A7521



SPECIAL CLOSEOUT DISCOUNT ON SYNERGY PRODUCTS LESS 50%

**OMNI SYNERGY****POOL CARE IN A BOX**

Contains everything needed to take care of a pool.
Just two easy steps, once-a-week for a bright & clear pool.
(A multifunctional oxidizer, clarifier and flocculant)

	PACKING	ITEM NO.
Synergy 10,000 Gallon Kit (Each System Box Containing 1 - 5.5 lb. Btl. Tabs & 5 - 1 lb. Btls. of Clear)	4-System Boxes	A7078+
Synergy 20,000 Gallon Kit (Each System Box Containing 2 - 5.5 lb. Btls. Tabs & 5 - 1 lb. Btls. of Clear)	2-System Boxes	A7077+
Initiator	2 - 2 x 12.5 Lb. Boxes/Cs.	A7076+
Simplicity Initiator	2 - 2 x 12.5 Lb. Boxes/Cs.	A7109
Synergy Tablets	12 x 1.5 Lb. Btls.	A7072+
Synergy Clear	12 x 1 Lb. Btls.	A7074+
Simplicity Synergy Clear	12 x 1 Lb. Btls.	A7119



+Limited Stock

**CLEAR COMFORT****NON-CHLORINE POOL PRODUCTS**

Clear Comfort Sanitizer (Hex Biguaidehypochloride)	4 x 1/2 Gallon Btls.	A7600
Clear Comfort Clarifier	2 x 1 Gallon Btls.	A7610
Clear Comfort Algaecide	12 x 1 Quart Btls.	A7605
Clear Comfort Stain Control	12 x 1 Quart Btls.	A7615
Clear Comfort Filter Cleaner	12 x 1 Quart Btls.	A7620
Clear Comfort Neutralize	12 x 2 Lbs. Btls.	A7625

**POLYCLEAR****CHLORINE FREE POOL CARE**

MaxiPolish (Hex Biguaidehypochloride) (Sanitizer)	8 x 1/2 Gallon Btls.	A4599
Peroxide Shock (Shock Treatment)	4 x 1 Gallon Btls.	A4603
PolyCide 50 (Algaecide & Algaestat)	18 x 1 Quart Btls.	A4600
PolyQuest (Mineral Controller)	18 x 1 Quart Btls.	A4602



NATURE2 POOL CARE SYSTEM



Natural Mineral Purifiers for Pools & Spas

Keeps pool water pure, clean & odor free. Reduces chemical use. Less maintenance. No more stinging eyes, damaged hair, dry skin or bleached fabrics. Uses patented non-electrical ceramic/silver media bed to destroy bacteria & viruses on contact.

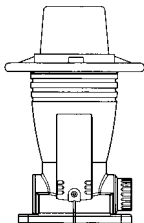

Professional G In-Ground Unit



Pro G Plus

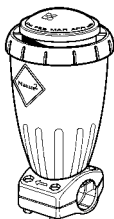

Express

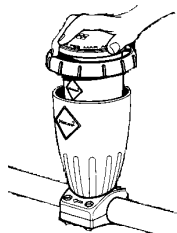

Express for Above Ground Pools

IN- GROUND POOLS

Professional G Nature 2 In-ground Vessel

1-1/2" Ports	A3225
Up to 45,000 Gallons, 2" Ports (Uses G25, G35 or G45 Cartridges)	A3230

Pro G Plus Dual in Ground Vessels

One for Mineral and One for Trichlor Tablets - 2" Ports (Uses G25, 35 or 45 Cartridges)	A3232
--	-------

Nature 2 Compact In-Ground Unit

Easy to Install In-Line	A3256
Up to 25,000 Gallons (Uses "Express" Cartridge)	

Express For In-Ground Pools with Automatic Pool Cleaners (Suction Side)

Up to 25,000 Gallons (Includes Cartridge)	A3227+
--	--------

ABOVE GROUND POOLS

Express Nature 2 Above Ground Unit

Easy to Install on Existing Pools	A3258
Up to 25,000 Gallons (Uses "Express" Cartridge)	

+Limited Stock

(See Page 36 for Zodiac Duo Clear Complete Sanitizing System Combining Mineral and Salt Technologies)

NEW NATURE 2 OXYGEN INFUSED AROMAS FOR SPAS

Pack of Four 2 lb Bottles (Non-Chlorine Shock)

Island Pleasures	A3270
Simple Rituals	A3271
Quiet Escape	A3272
Divine Secrets	A3273
Variety Pack	A3274



REPLACEMENT CARTRIDGES for Nature2 & Claritec Mineral Purifiers

		PACKING	ITEM NO.
A	Replacement Cartridge for Above Ground Units	4/Case	A3210
C20	Claritec Vision Replacement Cartridge	4/Case	A3260
C40	Claritec Vision Replacement Cartridge	4/Case	A3265
Express	Nature 2 Express Replacement Cartridge <i>Fits both Above Ground & In-Ground Units</i>	12/Case	A3257
G25	Model G In-Ground Replacement Cartridge <i>10,000 to 25,000 Gallons</i>	4/Case	A3235
G35	Model G In-Ground Replacement Cartridges <i>25,000 to 35,000 Gallons</i>	4/Case	A3240
G45	Model G In-Ground Replacement Cartridges <i>35,000 to 45,000 Gallons</i>	4/Case	A3245
M25	Premium In-Ground Replacement Cartridge	4/Case	A3220
APC	Replacement Cartridge for APC Unit	12/Case	A3212*

CARTRIDGE FILTER PURIFIERS

CF	CF for Cartridge Filters <i>Fits most Cartridge Filter Systems</i>	6/Case	A3251
-----------	---	--------	-------

Replacement Cartridge Filter for N2CW35
Nature 2 Purifying System (REPL N2C900-1750)

(See Page 123 for *SWIMPURE Nature2* Mineral Systems for Hayward Cartridge Filters)

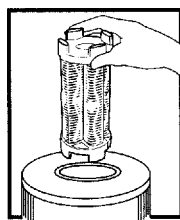

Drops into most
cartridge filters
Adapters Included

SPA PURIFIER UNITS

SPA12	Nature 2 Spa <i>Up to 1,000 Gallons</i>	12/Case	A3250
SPA36	Nature 2 Spa <i>Up to 1,000 Gallons</i>	36 Pack	A3255

NATURE 2 VESSEL (FEEDER) PARTS

Locking Ring #15725	A3312*
Locking Ring #15742 for Premier <i>Beige for PREM."M" & PROF."G"</i>	A3314*
O- Ring for 1 Piece Cap	A3302
O - Ring for 2 Piece Cap	A3324
Life Indicator for Professional "G" Unit	A3330
Inlet Port for Professional "G" Unit	A3348
Gasket for Professional "G" Unit	A3350
Inlet/Outlet O - Ring (2 Needed for Professional "G" Unit)	A3352
Flow Controller for Professional "G" Unit	A3354
Big Boy O - Ring for Professional "G" Unit	A3356
Outlet Port for Professional "G" Unit	A3358
Inlet/Outlet Port Assembly Complete Professional "G" Unit	A3360



Nature2[®] SPA

*Non-Stock Item

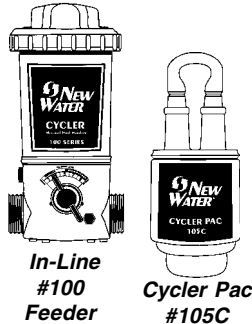

In-Line #100 Feeder

Cyclor Pac #105C

ABOVE GROUND CYCLER

	PACKING	ITEM NO.
Model #100 In-Line Feeder for Above Ground Pools 1-1/2" Up to 18,000 Gallons		C1296+
Model #130 Off-Line Feeder for Above Ground Pools Up to 15,000 Gallons		C1247+
New Water 3 System Kit <i>Cyclor pac/shock/3 month Algaecide</i>	4 Kits/Cs.	C1249+
Cyclor Pac #105C Pre-Filled Canister w/ 5 Lbs. of Trichlor For 400 & 430 Feeders	3/Cs.	C1237

ABOVE GROUND PARTS & ACCESSORIES

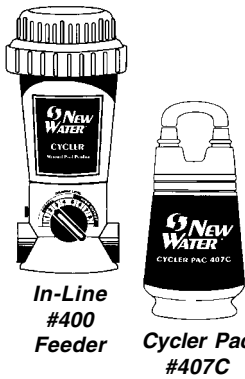

In-Line #400 Feeder

Cyclor Pac #407C

Cap with O-Ring		C1230*
O-Ring for Cap		C1267
Cap/Control Wrench		C1232

IN- GROUND CYCLER

Model #400 In-Line Feeder - 2" NSF Listed for Pools up to 40,000 Gallons.		C1294
Model #430 Off Line Feeder for Pools up to 25,000 Gallons		C1268
Cyclor Pac #407C Pre-Filled Canister with 7 Lbs. of Trichlor For 400 & 430 Feeders	3/Cs.	C1239

IN-GROUND PARTS 7 ACCESSORIES

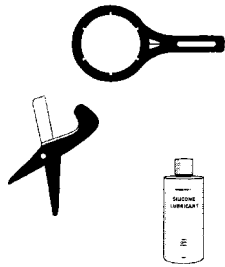

Replacement Cap w/ O-Ring		C1234
O-Ring for Cap		C1282
Cap/Control Wrench		C1231+
Pac Tool		C1265+
Silicone Lubricant - 3/4 Oz.		C1256
Mini Mizer Algae Preventative One dose <i>Prevents Algae Growth for 3 Months Handles up to 20,000 Gallons - Qt. Bottle</i>	12/Cs.	C1246+

+Limited Stock
*Non-Stock Item

AQUA SMART CYCLER PACS for Above Ground Pools

Aqua Smart 5 Lb. Chlorine Pac	3 - 5 lb. Cs.	C1223
Algae / Shock Kit #01-11-7300		C1224+
<i>Contains 32 Oz. - 90 Day Prevent Algaecide & 2 - 2 lb. Btl. Non-chlorine Shock & Clarifier</i>		
Aqua Smart Mineral Reservoir #01-13-5712		C1244
Chlorine Bac Pac 2.5 Lb. - Fits inside Mineral Reservoir	12/Cs.	C1250

+Limited Stock

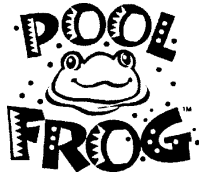

FROG MINERAL SYSTEMS



Above Ground Feeder



Inground Feeder

Frog Above Ground Package
Includes #6100 Frog Cyclor and Frog Mineral Reservoir in One Package
Up to 25,000 Gallons

PACKING ITEM NO.
(12/Case) C1226

Model # 5100 In-Line Frog Cyclor Only C1216+

Frog In-Ground Package
Includes #5400 Frog Cyclor and Frog Mineral Reservoir in One Package
Up to 40,000 Gallons

C1227

Frog In-Ground (Off-Line) Package
Includes #5430 Cyclor and Frog Mineral Reservoir in One Package.
For Off-Line Installation Only
Up to 40,000 Gallons

C1228

Model #5430 Off-Line Frog Cyclor Only C1221+
Model #5450 XL - Pro C1238

+Limited Stock

FROG RESERVOIRS



Above Ground Mineral Reservoir C1219
(Fits #5100 Series Frog Cyclor)
Pre-Filled canister with minerals for 6 months of continuous water purification.

In-Ground Mineral Reservoir C1229
(Fits #5400 Series Frog Cyclor)
Pre-Filled canister with minerals for 6 months of continuous water purification.



Frog Bac Pac (12/Case) C1225
(Fits #5100 & #5400 Series Frog Cyclors)
Pre-Filled with 2.4375 Lbs. of Trichlor



Frog Bam (12/Case) C1245
(For use in either Pool Frog Cyclor & Reservoir #5100 or #6100)
Unique mineral formula for preventing algae.
Guarantees 90 days of algae free water



Instant Frog Requires No Installation. C1235
Simply drops in Skimmer Basket and Lasts for 6 Months.
Purifies Existing Pools Up to 25,000 Gallons



SPA PRODUCTS



Spa Frog Floating System
(Includes Mineral & Bromine)



PACKING ITEM NO.
(12/Case) C1220

Spa Frog Mineral Cartridge (12/Case) C1218

Spa Frog Bromine Cartridge (12/Case) C1217

SPA MINERAL PURIFIER



Spa Frog (2 x 12 packs/Case) C1222
(Fits Most Cartridge Filters)
Lasts 4 Months, Works with Bromine or Chlorine



(See Page 40 For New Combination Salt Chlorine Generator/Frog Mineral System)



The Great Life Begins Here!

Algae Control



		PACKING	ITEM NO.
Algimycin "2000"	Multi-Purpose Algaecide	12 x 1 Qt. Btls.	A5056
Algimycin "2000"		4 x 1 Gal. Btls.	A5057
Algimycin "600"	Triple-Action 60% Algaecide	12 x 1 Qt. Btls.	A5053
Algimycin "1000"	Eliminates Toughest Algae	12 x 1 Qt. Btls.	A5052
Algimycin Yellow	Eliminates Yellow Slime	12 x 2 Lb. Btls.	A5012
Algae-X	Non-Foaming 30% Polymer Algaecide	12 x 1 Qt. Btls.	A5003
Strike Out	Copper Based Mustard Algae Control	12 x 1 Qt. Btls.	A5004
Vanquish	Treats Pink Slime	12 x 1 Qt. Btls.	A5112
Ultima	All in One Algaecide & Shock	6 x 3 Lb. Btls.	A5000
Ultima	Enzyme Clarifier	6 x 1/2 Gal. Btls.	A5001

Shock Treatment & Water Brighteners



Oxy-Brite	Oxidizer for Shock Treatment	40 x 1 Lb. Bags	A5006
Oxy-Brite		12 x 2.2 Lb. Btls.	A5005
Oxy-Brite		6 x 5 Lb. Btls.	A5010
Oxy-Brite		2 x 20 Lb. Btls.	A5009
Oxy-Brite		50 Lb. Pail	A5007
Clear Blue	Highly Concentrated Clarifier	12 x 1 Qt. Btls.	A5026
Clear Blue		4 x 1 Gal. Btls.	A5054
Party Blue	Blue Pool Water Dye	12 x 8 Oz. Btls.	A5027
Natural Clear	Natural Enzyme Action Clarifier	12 x 1 Qt. Btls.	A5021
Natural Clear		4 x 1 Gal. Btls.	A5095
Drop N' Vac	Non-Alum Floc	12 x 1 Qt. Btls.	A5049

Pool Opening Kit & Water Treatment

X-Change	Converts Biuanide Pools	12 x 1 Qt. Btls.	A5036+
GLB Pool Start Up Kit		2 X 1Kit	A5087

Stain Prevention & Mineral Control



Sequa Sol	Inorganic Sequestering Formula - Liquid	12 Qt. Btls.	A5015
Super Sequa Sol	Concentrated Stain Prevention - Gran.	12 x 2 Lb. Bts.	A5016
Super Sequa Sol		2 x 20 Lb. Btls.	A5017
Super Sequa Sol		50 Lb. Pail	A5019
Stain Magnet	Eliminates Metallic Stains	12 x 2.5 Lb. Btls.	A5097
Stain Magnet System		6 Sys./Case	A5099+

Filter & Surface Cleaner



Filter Cleanse	Removes Grease, Oils & Scale	12 x 2 Lb. Btls.	A5020
Filter Cleanse	Removes Grease, Oils & Scale	2 x 20 Lb. Pails	A5030
Filter Fresh	Acid-Based Cartridge Cleaner	12 x 1 Qt. Btls.	A5089
Filter Rinse	Cartridge Cleaner	12 x 1 Qt. Btls.	A5088
TLC	Tile & Liner Cleaner	12 x 1 Qt. Btls.	A5025
TLC		4 x 1 Gal. Btls.	A5094
Cover Care	Cover Cleaner, Deodorizer	12 x 1 Qt. Btls.	A5086
Bug Out	Removes Insects from Water	12 x 1 Qt. Btls.	A5084+



RENEZVOUS SPA PRODUCTS



Sanitizers

		PACKING	ITEM NO.
Enhance	<i>Banks Bromide Salts for Release w/Activate</i>	24 x 1 Pt. Btls.	A5042+
Enhance		12 x 1 Qt. Btls.	A5040
Enhance		4 x 1 Gal. Btls.	A5045
Activate	<i>Shocks & Releases Bromide from Enhance</i>	12 x 2 Lb. Btls.	A5048
Activate		6 x 5 Lb. Btls.	A5050
Activate		2 x 20 Lb. Btls.	A5055
Bromine	<i>Brominating Tablets</i>	12 x 2 Lb. Btls.	A5024
Bromine		6 x 4 Lb. Btls.	A5023
Broma-Start	<i>For Initial Bromide Reserve</i>	12 x 2 Oz. Pks	A5031
Spa Care Kit	<i>(Bromine) Includes Video</i>	4 Kits/Case	A5041
Spa Care Kit	<i>(Chlorine)</i>	4 Kits/Case	A5046
Conc. Granular Chlorine-Dichlor		12 x 1 Lb. Btls.	A5034
4-Way Test Strips	<i>(50/Bottle)</i>	12 x 1 Lb. Btls.	A5038+



Water Treatment



Spa Clarifier	<i>Restores Sparkle to Dull Water</i>	12 x 1 Pt. Btls.	A5079
Spa Clarifier		12 x 1 Qt. Btls.	A5078
Foam Out	<i>Prevents & Eliminates Foam</i>	12 x 1 Pt. Btls.	A5070
Foam Out		12 x 1 Qt. Btls.	A5076
Foam Out		4 x 1 Gal. Btls.	A5077
Spa Increase	<i>Raises pH & Alkalinity Easily - Liquid</i>	12 x 1 Pt. Btls.	A5043
Spa Decrease	<i>Lowers pH & Alkalinity Easily - Liquid</i>	12 x 1 Pt. Btls.	A5044
Liquid Calcium Hardness Up	<i>Protects Equipment</i>	12 x 1 Qt. Btls.	A5051
Natural Clear	<i>Enzyme Action Scum Remover</i>	12 x 1 Pt. Btls.	A5037
Alkalinity Up	<i>Raises Water Alkalinity</i>	12 x 1 Lb. Btls.	A5066
Ph Up	<i>Raises Water pH</i>	12 x 1 Lb. Btls.	A5063
Ph Down	<i>Lowers Water pH</i>	12 x 1 Lb. Btls.	A5064
Ph Magic	<i>Stabilizes pH Levels</i>	6 x 3 Lb. Btls.	A5059

Under Surface Maintenance

Cell Saver (For Salt Generators)		12 x 1 Qt. Btls.	A5032
Tub Rinse (Cleans Tub & Plumbing lines, etc.)		12 x 16 Oz. Btls.	A5033

Surface & Equipment Maintenance



Protect Plus	<i>Protects Against Stains, Scale & Rust</i>	12 x 1 Pt. Btls.	A5061
Protect Plus		12 x 1 Qt. Btls.	A5060
Filter Fresh	<i>Removes Oils & Mineral Scale</i>	12 x 1 Pt. Btls.	A5028
Spa Cleaner	<i>Removes Oil, Grime & Scale Deposits</i>	12 x 1 Pt. Btls.	A5022
Look! It's Bob	<i>Surface & Water Cleaner - Absorbent</i>	18/Case	A5101
X34 Power Pad	<i>Tile & Spa Cleaning Pad</i>	12/Case	A5013
Spa Lustre	<i>Polishes & Protects Spa</i>	12 x 1 Pt. Btls.	A5090
Minute Rinse	<i>Instant Cartridge Cleaner</i>	12 x 1 Pt. Btls.	A5080



In-Spa Fragrances

Tahitian Moonlight		12 x 8 Oz. Btls.	A5071
St. Moritz Sunrise		12 x 8 Oz. Btls.	A5072+
Aegean Twilight		12 x 8 Oz. Btls.	A5073
Mediterranean Breeze		12 x 8 Oz. Btls.	A5074
Mixed P.O.P Display		12 x 8 Oz. Btls.	A5075



+Limited Stock



NATURAL CHEMISTRY

Natural enzyme formulas for removal of suntan lotions, body oils & perspiration from pool & spa water

ITEM NO.

Pool Perfect Concentrate Weekly dose prevents scum & waterline ring

12 x 1 Liter Btls. A6521
6 x 2 Liter Btls. A6522
4 x 3 Liter Btls. A6502



Pool Perfect for Baquacil

4 x 3 Liter Btls. A6504+

Spa Perfect Helps prevent scum & waterline buildup. Ends soaking & scrubbing of cartridge filters

12 x 1 Pt. Btls. A6506
12 x 1 Liter Btls. A6507
6 x 2 Liter. Btls. A6513



PHOSFree Eliminates phosphates from pools

6 x 2 Liter Btls. A6515
4 x 3 Liter Btls. A6516



Spa Purge Removes organic wastes from the plumbing 12 x 1L. A6523

PHOSFloc Bulk phosphate remover 6 x 4 Lb. Btls. A6534

Pool Perfect Concentrate + PHOSFree

6 x 2 Liter Btls. A6525
4 x 3 Liter Btls. A6518



PHOSFree & Pool Perfect Conc + PHOSFree 2 step start-up kit
3 Kits / Case A6517+

Pool Magic + PHOSFree Closing dose to assure no algae
12 x 1 Liter Btls. A6520

Pool Magic Spring & Fall

For spring start-up. Eliminates winter waterline ring. Preserves pool liner & finish. Reduces staining
12 x 1 Liter Btls. A6505



Pool First Aid

Gets rid of scum build-up, waterline ring, cloudy water, clogged filters & chemical odors w/no scrubbing
6 x 2 Liter Btls. A6500

Metal Free Deactivates, iron, copper & other trace metals without adding phosphates

12 x 1 Liter Btls. A6529

Bio Clean Removes stains & odors from spa covers & outdoor furniture

12 x 22 Oz. Btls. A6508



Clean & Perfect All surface grease, grime & dirt remover

12 x 22 Oz. Btls. A6509

Hair Revitalizer Neutralizes chlorine at poolside without shampooing

12 x 8 Oz. Btls. A6511+

Stain Free

12 x 1.75 Lbs. A6546



Perfectly Clear Ultimate 6 in 1 Clarifier

12-1 Pint Btls. A6540+
12-1 Qt. Btls. A6538+

Clear, Perfect Algae Free Water Kit

Small Kit Treats 12,000 gallons for 8 weeks. Comes with:

1-L Pool Magic + PHOSFree & 1-L Pool Perfect + PHOSFree 6 Kits / Case A6527+

Large Kit Treats 20,000 gallons for 12 weeks. Comes with:

1-L Pool Magic + PHOSFree & 3-L Pool Perfect + PHOSFree 4 Kits / Case A6536+

+Limited Stock

NATURAL CHEMISTRY SALT WATER KITS

		ITEM NO.
Salt Water Start-Up Kit	4/Cs 8 x 1Lb. Bag	A6526
<i>Multi-mineral mix for chlorine generators. Treats 6,000 gal.</i>		
Salt Water Monthly Kit	4/Cs 8 x 1Lb. Bag	A6528
<i>Establishes and maintains mineral/salt levels required for proper generator performance. Treats 20,000 gal.</i>		
Liquid Salt Water Magic	1L/33.9Oz	A6531
<i>Removes Phosphates and Organics</i>		
Salt Water Magic 5 Lb. Foundation	8 x 5Lb.	A6535
<i>Starts off salt pools with required chemicals. Metal deactivator, conditioner, Phos. remover, etc.</i>		
Salt Water Magic 2 Lb. Support	12 x 2Lb.	A6533
<i>Tops off Salt pools.</i>		



PREVENTION

The Blue Stuff (Copper Problems)	12 x 1 Qt. Btls.	A6710
<i>Super strength sequestering agent. Helps remove stains & scale in older pools.</i>		
The Pink Stuff (Metal Problems)	12 x 1 Qt. Btls.	A6700
<i>Recommended start-up product for stain & scale prevention. Controls plaster dust.</i>		
The Ionizer Stuff (Aids Ionization Systems)	12 x 1 Qt. Btls.	A6720
<i>Designed to prevent staining w/copper sanitation systems. Helps keep water soft & crystal clear.</i>		
The Purple Stuff (For Salt-Water Pools)	12 x 1 Qt. Btls.	A6730
<i>Recommended for pools in which traditional sequestering agents don't work due to high salt levels.</i>		

MAINTENANCE

The All Fixed Up Stuff (Weekly Maint.)	12 x 1 Qt. Btls.	A6770
<i>An extra strength clarifier to make pool water sparkle. Enhances chlorine's ability to prevent algae growth.</i>		
The Clean Stuff (Clean Water Solution)	12 x 1 Qt. Btls.	A6722
<i>Enzyme pool water cleaner. Helps prevent & remove buildup caused by lotions & oils.</i>		
The Yellow Stuff (All-Purpose Algaecide)	12 x 2 Lb. Btls.	A6766
<i>Quickly eliminates algae breakouts. Safe to swim 2 hours after treatment.</i>		

REMOVAL

The Step Stuff (Yellow-Brown Stains)	12 x 8 Oz. Btls.	A6760
<i>Removes yellow-brown stains from vinyl liner pool steps.</i>		
Stain Solution # 1 (Iron, Cobalt & Etching)	12 x 2 Lb. Btls.	A6732
<i>Removes iron, cobalt and spot etching stains from all types of pool surfaces without draining pool.</i>		
Stain Solution # 2 (Copper & Scale)	4 x 5 Lb. Btls. 4 x 10 Lb. Pail	A6738 A6740
<i>Removes copper stains and scale from all types of pool surfaces without draining the pool.</i>		
O2 Safe Shock (Non-Chlorine Shock)	4 x 5 Lb. Btls.	A6726
<i>Helps remove gray/black copper stains.</i>		
After Shock (Chlorine Reducer) (24-1 Lb. Bags)		A6716
<i>Used in stain removal system</i>		

TESTING

Topical Test Kit (Stain Identification)	Each	A6750
<i>Designed to take all the guesswork out of removing swimming pool stains.</i>		
Sequest Test Kit	Each	A6752
<i>Measures working sequestering agents</i>		
Sequest #1 Tablet (Pack of 100)		A6753
Sequest #2 Reagent (Each)		A6754



SEA-KLEAR



SEA-KLEAR 4-In-1 Clarifier for Pools

Made from crab shells (Cobalt Blue). Natural Clarifier -
 Attracts organic debris with chitosan & carries
 it to the filter. Also traps stain-causing heavy metals
 & helps improve filter efficiency.

ITEM NO.
 12 x 1 Qt. Btls. A7136
 24 x 4 Oz. Btls. A7139



SEA-KLEAR Chlorine-Free Shock

Oxygen based oxidizer burns up organic waste.
 Chloramines converted back into free available chlorine.

24 x 1 Lb. A7700+

SEA-KLEAR Zero-Phos

Phosphate remover prevents algae by eliminating its
 food source essential for its survival.

12 x 1 Qt. Btls. A7735

SEA-KLEAR 3-Month Algaecide

Non-foaming, organo-copper formula for all strains of algae.

12 x 1 Qt. Btls. A7133



SEA-KLEAR Bromine Spa Care Kit

Bromine based spa starter kit for easy care of spas.

6/Cs. A7740+

SEA-KLEAR Particle Removal System Kit

#11300011 2 x 1 Quart Sets
 # 1130002 2 x 1 Gallon Sets

Sets A7131
 Sets A7134



SEA-KLEAR Natural Clarifier Tabs

#1060005 24 x 2 Tabs
 #1130001 24 x 2 Tabs

1/Case A7140+
 1/Case A7142

SEA-KLEAR SKV-U-Q Leak Sealer

12x1Qt./Case A7720+

SEA-KLEAR SKJ-U-Q Filter Cleaner

12x1Qt./Case A7143+

SEA-KLEAR Metal Klear

12x1Qt./Case A7144

SEA-KLEAR Natural Stain Remover

12x2lb./Case A7145

+Limited Stock

IBS ENZYMES, INC.



Concentrated Pool Winterizer and Spring Start up With Phosphate Control

Also used for Spring Start Ups. Zaps oily substances in water, prevents bathtub rings on walls and tile.
 Reduces oxidizer consumption. 1 Liter dosage treats 33,900 Gallons.

12 x 1 Liter Btls. A6650

JONAS



Keetrol Plus

Liquid stain prevention

12 x 1 Qt. Btls. A3905

Ascorbic Acid

Granular product removes stains from bottom of pools. Safe to use for concrete & vinyl pools.

12 x 2 Lb. Btls. A3910

Saltique Restore

Helps prevent build-up of Scale, Oil, and Mineral Deposits that tend
 to lessen the life of the salt generator cell.

12x1Qt./Case A7750

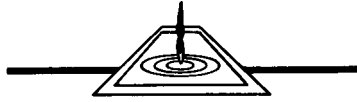

UNITED CHEMICALS

ITEM NO.



Easy Acid *Lowers total alkalinity & pH*

45 x 1 Lb. Bags A3144

Easy pH *Raises pH strongly & alkalinity weakly*

40-6 Oz. Bags A3142

No Drain Acid Wash - 20,000 Gal. Kit *Removes stains on any pool surface*
A3152



No More Problems *Prevents start or return of algae slim & mold*
12 x 32 Oz. Btls. A3128

Pool Stain Treat *Removes stains caused by metals*

48 x 4 Oz. Bags A3132
12 x 2 Lb. Btls. A3134

Black Treat *Controls black algae*

12 x 3 Lb. Btls. A3116

Green Treat *Controls green algae*

12 x 2 Lb. Btls. A3118



Pink Treat *Controls red & pin algae*

12 x 2 Lb. Btls. A3120

Yellow Treat *Yellow & mustard algae killer*

12 x 2 Lb. Btls. A3114

Cobalt Cure *Removes brown, gray & blue stains on fiberglass*

12 x 2 Lb. Btls. A3138

Winter Treat

12 x 1 Qt. Btls. A3939

SWIMFREE

Limited Supply
SPECIAL CLOSE OUT SALE 50%



Algalator *Coagulates dead algae & debris*

24 x 1 Pt. Btls. A2200+

Claritabs *Water clarifier tablets*

12 Paks/ Cs. A2201+



Hydroquest *For iron & manganese staining problems*

Regular 12 x 1 Qt. Btls. A2205+

Extra Strength 12 x 1 Qt. Btls. A2206+

X-tra Blue Water Polisher

24 x 8 Oz. Btls. A2208+

Waterline Cleaner

24 Pints/Cs. A2209+

+Limited Stock

ACCU-TAB - Tablet Chlorination System

A chlorinating system designed to provide accurate, consistent & controlled delivery of calcium hypochlorite tablets for a wide range of pool, spa & related applications. No need for expensive equipment or bulky drums.



- * NSF Approved
- * Less Maintenance than Bleach
- * Large Delivery Capacity
- * Safer than Chlorine Gas

- * Alternative to Chlorine Bleach
- * Accurate Chlorine Delivery
- * No Moving Parts
- * No Cyanuric Acid Buildup



Model 3012 Chlorinator (Clear See-Thru Shell)

For Pools Up to 75,000 Gallons
Tablet Capacity - 12 lbs.

ITEM NO.
A2324

Model 3075 Chlorinator

For Pools Up to 300,000 Gallons
Tablet Capacity - 75 lbs.

A2326*

Model 3150 Chlorinator

For Pools Up to 1 Million Gallons
Tablet Capacity - 150 lbs.

A2328*

Model GT 100 Titan Chlorinator

For Pools Up to 150,000 Gallons
Tablet Capacity - 150 lbs.

A2325

* Non-Stock Item

(Non-Refundable Net Deposit)



POWERPAC AT - Chlorination Units

New Accu-Tab sanitizing system that incorporates PPG chlorinator w/1 HP pump & 22 gallon balance tank for below grade & above grade filter rooms. Preplumbed & prewired for easy installation & reliable chlorine delivery. Easily adapts to chlorine controllers. - UL Listed

Model 3012 PowerPac AT

For Pools up to 75,000 Gallons

A2333*

Model 3070 PowerPac AT

For Pools up to 300,000 Gallons

A2331*

Model 3070 PowerPac AT w/Webtrol Pump

A2334*

Model 3140 PowerPac AT

For Pools Up to 1 Million Gallons

A2330*

Model 3140 PowerPac w/Webtrol Pump

A2332*

Model 3500 PowerBase For High Head Webtrol Pump

A2338*

CHLORINATING TABLETS

Accu-Tab Blue SI Tablets - 55 Lb. Pail
w/Scale Inhibitor (tablet contains 70%)

A2323

MODEL 3012 PPG FEEDER PARTS

- Cap O-Ring
- Tablet Cannister
- Lid w/ O-Ring
- PPG 1" Kerrick Float Valve

- A2337
- A2348
- A2360
- A2321

Flow Spigot 1/2" HD Polyethylene

A2327

Flo Control Adjustable Strap Wrench

V7228

PPG High Limit Switch #M8710

A2320* *Non-Stock Item

SOLENOID VALVES AND RELATED PARTS

	ITEM NO.
Watermatic 3-161 3/4" Solenoid 24V (Replaces 3-160 1")	D7080
CO2 Feeder w/SS Selenoid, Injector Check Valve & Immersion Stone	V8050
CO2 Feeder w/2-SS Selenoid, 2 Injector Check Valve & Immersion Stone	V8052
CO2 Feeder w/3-SS Selenoid, 3 Injector Check Valve & Immersion Stone	V8054
Coil 24V - D300B2	A2296
Coil 110V - D1D2P3	A2297
Coil 110/120V - D100P3	A2298
1/8" CO2 Solenoid Valve - 71215SN1MNOOM0D100P3 110V	A2308
1/4" CO2 Solenoid Valve - 71215SN1MNOON0D100P3 110V	A2303
3/4" Solenoid Valve - 7221GBN51N00N0D100P3 24V	A2299
3/4" Solenoid Valve - 7221GBN51N00N0D1D2P3 110V	A2301
1" Solenoid Valve - 7221GBN64N00N0D100P3 110V	A2302
1-1/2" Parker Solenoid Valve - PASV150B 110V	A2306
3/4" Valve Rebuild Kit - 7KG03	A2304
1" Valve Rebuild Kit - 7KG05	A2305
1-1/2" Parker Rebuild Kit - 7KG08	A2307

STRAINERS

1/4" x 1/4" SMS #7083490 In Line Strainer	D7196
1" x 1" SMS #7083390 In-Line Strainer	D7198
1/2" x 1/2" SMS #7080690 In-Line Strainer	D7194
3/4" x 3/4" SMS #7082890 In-Line Strainer	D7195
1" x 1" SMS #7083390 In-Line Strainer	D7198
1-1/2" SMS #573690 Strainer N-1/5-80-B	D7197
1/4" SMS #5580330 Inside Strainer Screen	D7199
3/4" SMS #5730330 Inside Strainer Screen	D7200
1" SMS #5580420 Inside Strainer Screen	D7201
1-1/2" SMS #5730070 Inside Strainer Screen	D7202
SMS #5580220 Clear Plastic Dome for 3/4" Strainer	D7203
SMS #5580220 Clear Plastic Dome for 1" Strainer	D7204

MAZZEI INJECTORS

MAZZEI #05844 Venturi Injector 3/4"	A2370
MAZZEI #CR-2 Rebuild Kit	A2374

Ultra Violet Products

RESIDENTIAL POOL OZONATORS



ZO-912 Delzone for Residential Pools
up to 50,000 Gallons
Includes Injector.
Twice the ozone of ZO-910.
Double Lamp
Designed for Permanent or Portable Installation.

ITEM NO.

D6006

ZO-940 Delzone for Pools up to 30,000 Gallons

D6015



RESIDENTIAL SPA OZONATORS

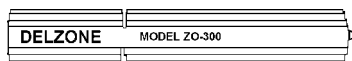

ZO-300 RAM Delzone for Spas up to 1,000 Gallons
UL Listed. Installs in minutes. Plugs into GFCI protected outlet.

D6005

ZO-900 Delzone for Spas up to 1,000 Gallons.
110V

D6000

ZO-302 Ram Delzone for Spas up to 1,000 Gallons.
240V.

D6016

DEL ACCESSORIES & PARTS

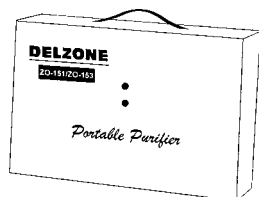

IU201 Del Rigid Injector

D6020

IU206 Injector Manifold - Adjustable

D6022

IU216 Injector Manifold - High Air Flow Rate

D6023

Injector for only Standard Manifolds

D6053

Check Valve, CH Series #8-0333

D6140

Check Valve, Ozone Supply (*New Style*)

D6033

Check Valve, 1/3

D6073

Tubing, 1/4" ID, Ozone Supply - Per Ft.

D6054

Saddle Clamp Assembly for Ozone Supply Tubing #9-0001

D6034

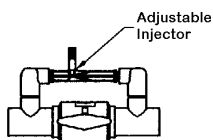

Lamp for ZO-101

D6030

Lamp for ZO-101C, PZ-2000 & PZ-200

D6046+

Lamp for ZO-940/942, & ZO-840/842

D6048

Lamp Cartridge for ZO-300 & ZO-302

D6049

Lamp - Small, U-Shape for "Mini" ZO-137

D6040

Lamp for ZO-500, ZO-900, 910 & 912W (*Wire Leads*)

D6047

Lamp for ZO-500, ZO-900, 910 & 912 (*4 Pin w/Grommet*)

D6057

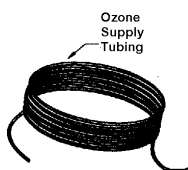

Lamp Only for LK2000

D6060+

Lamp - Large, U-Shape for ZO-810 thru ZO-830

D6035

Ballast for ZO-200/151/152/153, Del # 5-0240

D6052

Ultrapure Check Valve Kit

V6700

+Limited Stock

ECLIPSE

CORONA DISCHARGE OZONATORS for Residential Pools

(Parts bag including injector - Sold Separately)

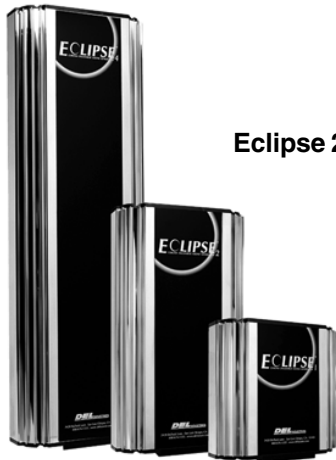

			ITEM NO.
Eclipse 1 (EC-1)	Corona Discharge Ozone Generator	120V	D6080
	Single CD Electrode (0.3 Grams per Hour)	240V	D6090

Sizing Guidelines for Residential Pools:

7,000 Gallons w/ Ozone as Primary Oxidizer

25,000 Gallons w/ Ozone as Secondary Oxidizer

Eclipse 2 (EC-2)	Corona Discharge Ozone Generator	120V	D6082
	Double CD Electrode (0.5 Grams per Hour)	240V	D6092

Sizing Guidelines for Residential Pools:

15,000 Gallons w/ Ozone as Primary Oxidizer

50,000 Gallons w/ Ozone as Secondary Oxidizer

Eclipse 4 (EC-4)	Corona Discharge Generator	120V	D6084
	Quad CD Electrode (1.0 Grams per Hour)	240V	D6094

Sizing Guidelines for Residential Pools:

25,000 + Gallons w/ Ozone as Primary Oxidizer

100,000 Gallons w/ Ozone as Secondary Oxidizer

Total Eclipse 24-Hour (ECT-2)	Corona Discharge Ozone Generator		D6086
--------------------------------------	----------------------------------	--	-------

(0.4 Grams per Hour). Double CD Electrode with Built-in Recirculation

Pump for 24 Hour Operation. Runs Independently from other equipment.

Sizing Guidelines for Residential Pools:

25,000+ Gallons w/ Ozone as Primary Oxidizer

60,000 Gallons w/ Ozone as Secondary Oxidizer



DEL MDV-10 Mini Degas Valve Kit for EC-1, 2 & 4 (Includes injector, unions & parts)	D6064+
Parts Bag for Total Eclipse Ozonators EC-1, 2 & 4 (Includes injector manifold)	D6116
Parts Bag for In-Ground Pools #9-0271 (includes injector manifold)	D6018
Replacement Corona Discharge Electrode DEL 5-PAO213	D6041
DEL Check Valve	D6073

+Limited Stock

CORONA DISCHARGE OZONATORS for Spas

Spa Eclipse (ECS-1) Standard Unit.	120V	D6003
---	-------------	-------

Corona Discharge Ozone Generator for Residential Spas. Solid State Electronics. **UL Listed**

Spa Eclipse (ECS-IRPAM) Corona Discharge Unit w/Pin Type Plug	120V	D6008
--	-------------	-------

Spa Eclipse (ECS-IRPAM) Corona Discharge Unit w/Pin Type Plug	240V	D6017
--	-------------	-------

Parts Bag for all Spa Eclipse Ozonators DEL 9-0482ECS	D6118
---	-------

Replacement Chip for all Eclipse Spa Ozonators DEL 5-0561	D6076
---	-------

OZONATORS For Commercial Or Large Residential Applications

LK-2000V Delzone for New or Existing Facilities	D6019+
--	--------



Vacuum Only. Includes Injector manifold. **NSF Listed**

For Pools up to 100,000 Gallons w/ Ozone as Secondary Oxidizer

+Limited Stock

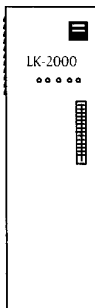

Contact Our Commercial Division for Sizing Specifications & Information on Additional Corona Discharge Systems.

GOLDLINE
CONTROLS INC.



D3030

GOLDLINE CONTROLS

		Item No.
AQ-Rite	Automatic Chlorine Generator <i>(For In-Ground Pools Up to 40,000 Gallons)</i>	D3000
PL-Plus	Automatic Chlorine Generator Aqua Plus Control with Generator <i>(For In-Ground Pools Up to 40,000 Gallons)</i>	D3001
AQL-CL	Automatic Chlorine Generator <i>(For In-Ground Pools Up to 40,000 Gallons)</i> Cell w/ flow switch	D3003
AQ-Troi-RJ	Automatic Chlorine Generator <i>(For Above Ground Pools up to 18,000 Gallons)</i> monitors water temperature, flow & salt level of pool Interfaces with Jandy AquaLink remote control. 5-year warranty	D3005
PL PS-8 Pro	Aqua Logic Control with Sub-Panel	D3006
GLX-Flo RP	Flo Switch with 25' cable and 2" tee fitting	D3008
GLX-CELL-15	Turbo Cell w/15 Ft cable for Aqua Logic/Rite	D3010
GLX-CELL-25	Turbo Cell w/25 Ft cable for Aqua Logic/Rite	D3012
GVA-24	Valve Actuator - 24V	D3030
GLX CELL Union	Union nut and tailpiece - 2"	D3031

Jandy



AquaPure1400	AquaPure System with 16' cable <i>In home control with AquLink RS interface.</i> <i>Includes 2" PVC Unions</i> <i>(For In-Ground Pools Up to 40,000 Gallons)</i>	D4201
AquaPure 700	AquaPure System with 16' cable <i>(For In-Ground Pools up to 15,000 Gallons)</i>	D4203
	PureLink Cell Kit <i>PLC1400 14 Blade Cell w/ 16 Cables</i> <i>2" Unions, Sensor tec & Sensor</i>	V5815
	PureLink Subpanel Power Center for 14 Blade Cell	V5811

Balboa



BALBOA

EcoSpa 110v	For Portable Spas up to 500 Gallons and fountains	D3013
EcoSpa 220v		D3014
ECOmatic	Provides crystal clear water naturally. <i>Unique clear cell design makes it easy to inspect.</i> <i>5 year pro-rated warranty.</i>	D3011
ESC36	For Commercial and In-Ground pools <i>Provides crystal clear water naturally. Unique clear cell design makes it easy to inspect. 5 year pro-rated warranty.</i> (For In-Ground Pools Up to 45,000 Gallons)	D3016
ESC48	For Commercial and In-Ground pools <i>Provides crystal clear water naturally. Unique clear cell design makes it easy to inspect. 5 year pro-rated warranty.</i> (For In-Ground Pools Up to 60,000 Gallons)	D3015

POLARIS

LM3	Salt Water Chlorinator	D3007
------------	------------------------	-------

SMARTPOOL



SMARTPOOL

for Above Ground Pools

ChlorEase
Saltwater Chlorinator

SmartPool ChlorEase	Above Ground Electronic Chlorine Generators <i>3 year warranty</i> (For Above Ground Pools Up to 18,000 Gallons)	D3009
----------------------------	---	-------

Hybrid Salt Generators

Generators that perform multiple sanitation tasks

DEL Trio-Pure - Combination Chlorine Generator/Ozone Generator



Trio - 25
(Up to 25,000 Gallons)
Trio - 50
(Up to 50,000 Gallons)

Item No.
D6102
D6098

The TrioPure® combines Ozone (the most powerful pool oxidizer/sanitizer) and salt water electrolysis (which creates chlorine from salt) to form superior oxides at the point of mixture. This process, called the Advanced Oxidation Process (AOP) further sanitizes and destroys microorganisms in your swimming pool water and it can only be found on the patent pending and ETL certified TrioPure.

POOL FROG (King Technology) Combination Chlorine Generator/Frog Mineral System



Pool Frog Mineral Hybrid
(Up to 40,000 gallons)

D6104

Pool Frog combines the renowned Frog mineral technology with salt chlorine generation to give you the best of both worlds. The mineral technology reduces your chlorine consumption by 50%, combine this with cost saving chlorine generation and you have an ideal solution for sanitizing your pool. 7-Year Warranty

ZODIAC - DuoClear Complete Pool Sanitizing System



DuoClear Complete
(Up to 45,000 gallons)

D6105

Zodiac's DuoClear system utilizes Zodiac Nature²® and Clearwater® technologies, two of the leading pool sanitizing systems on the market. The innovative use of these technologies provides an extraordinarily efficient, and effective sanitizing system that actually leaves pool water feeling fresher and gentler than you ever thought possible — automatically!

Pentair Intellichlor

INTELLICHLOR IC40 - #520555 <i>(For Inground Pools up to 40,000 Gallons)</i>	Item No. D3020
INTELLICHLOR Power Center for IC40 - #520556	D3021
INTELLICHLOR Pass Through Cell <i>A blank cell that you put in the intellichlor system that is used for the winterizing or start up.</i>	D3022
INTELLICHLOR Union Replacement (2 per set)	D3023



Intermatic I-Pure Salt Chlorine Generator

I-Pure PE40K240V - 240V for pools up to 40,000 Gallons D3100

CHLORINE GENERATOR SUPPLIES & ACCESSORIES

NATURAL CHEMISTRY SALT WATER KITS

			Item No.
Salt Water Start-Up Kit	4/Cs	8 x 1Lb. Bag	A6526
<i>Multi-mineral mix for chlorine generators Treats 6,000 gal.</i>			
Salt Water Monthly Kit	4/Cs	8 x 1Lb. Bag	A6528
<i>Establishes and maintains mineral/salt levels required for proper generator performance. Treats 20,000 gal. Salt - Evaporated</i>			

SALT FOR CHLORINE GENERATORS

<i>Used in chlorine generation & water softening</i>		
Granular	40 Lb. Bag (63 Bags/Pallet)	D5502

ACCESSORIES FOR POOLS WITH CHLORINE GENERATORS

Cell Saver (For Salt Generators)	12 x 1 Qt. Btls.	A5032
Jonas Saltique Restore <i>Helps prevent Build-Up of Scale, Oil, and Minerals that can decrease generator cell life.</i>	12x1Qt./Case	A7750
Tool: Anti-Electrolysis Basket Weight		V7213
Tool: Anti-Electrolysis In-Line Zinc Anode <i>A must for Salt Water pools, prevents damage caused by electrolysis.</i>		V7216
Intermatic Sacrificial Zinc Anode <i>Attaches to the...</i>		G7060

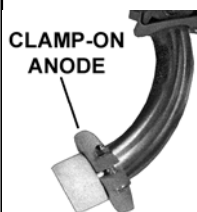

A6526



A6528

Salt Water Magic Monthly Kit

The ONLY way to KEEP a chlorine generator pool running

1x1L/33.9oz & 1x5.5lb bag A6528

One kit treats up to 20,000 gallons

- convenient monthly kit restores necessary salt/mineral levels & removes phosphates
- provides the perfect pool water environment continually for chlorine generators

CAT CONTROLLERS

- * *Digital Design Technology*
- * *Compatible w/ Existing Chemical Feeders*
- * *Waterproof Touch-Screen Front Panel*
- * *Simple Installation & Operation*
- * *Visual & Audible Safeguard Alarms*
- * *5 Year Warranty on Controller*



		ITEM NO.
CAT 2000	- pH/ORP Controller Complete w/ Sensors <i>Microprocessor-based automated controller</i>	V4620
CAT Pro-Pack	- Pre-assembled Automation System <i>Cat 2000 controller & AC075 flowcell w/rotary flow sensor on 24" pvc backboard</i>	V4633
CAT 4000	- Wireless Controller <i>Offers offsite monitoring and data logging through internet access anywhere. Requires monthly subscription</i>	V4624
CAT 5000	- Web-Based Controller <i>With Global Wireless Coverage</i>	V4621
CAT RA015	- Remote Antenna 15' Cable and Mounting Bracket	V4644

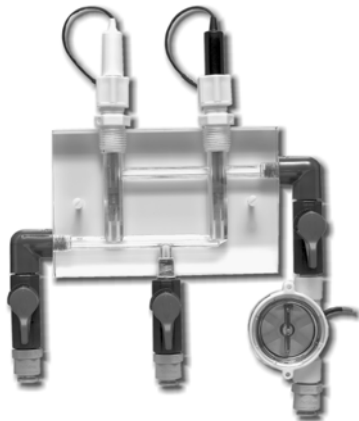

V4628 Flow Cell w/Rotary Sensor

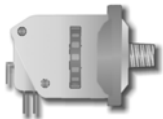

V4626 Flow Sensor

Flow Cell w/ Rotary Flow Sensor	V4628
<i>Machined acrylic flow cell kit w/ pre-installed rotary flow sensor</i>	
1/4" Ball Valve MxF	A2329
<i>For CAT flow Cell</i>	
3 Year pH/ORP Probe Set	V4668
<i>#PRO30/PRO35</i>	
In-Line pH Sensor	V4629
<i>Heavy duty 1/2" NPT (2 year warranty)</i>	
In-Line ORP Sensor	V4630
<i>Heavy duty 1/2" NPT (2 year warranty)</i>	
IN-LINE pH SENSOR H.D.	V4660
<i>1/2" NPT W/10' WIRE</i>	
IN-LINE ORP SENSOR H.D.	V4662
<i>1/2" NPT W/10' WIRE</i>	
24 Volt Solenoid Valve (Brass)	V4625
<i>For use w/ erosion or PPG feeders, 3/4"</i>	
Flow Sensor (Pressure)	V4626
<i>Disables feeding during low-flow conditions</i>	
Flow Sensor (Rotary)	V4664
<i>Disables feeding during low-flow conditions</i>	
Locking Enclosure Option	V4627
<i>Recessed enclosure with 2 keys</i>	
PVC Backboard	V4634

STANDARD CO2 SYSTEM

Ideal for Small to Medium Pools & Spas. Adjustable Output control.

AC004

V4632

HIGH OUTPUT CO2 SYSTEM

Ideal for Medium to Large Pools. Adjustable Output Control.

AC005

V4642



Standard CO2

HAYWARD CHLORINATORS & BROMINATORS

Smaller Capacity Feeders

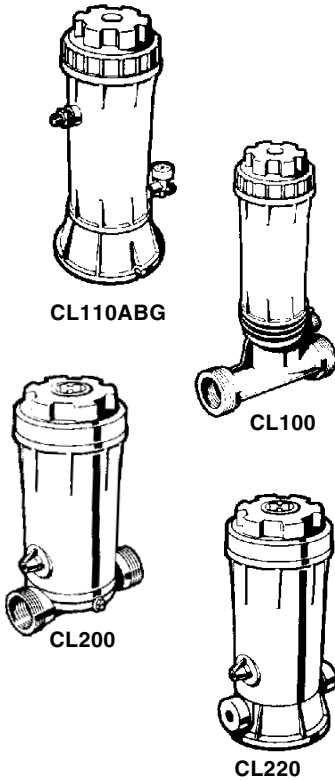

	ITEM NO.
Hayward CL110ABG Off-Line Chlorinator <i>4.2 Lb. Capacity (for Above Ground Pools)</i>	C1061
Hayward CL110 Off-Line Chlorinator <i>4.2 Lb. Capacity</i>	C1088
Hayward CL100 In-line 1-1/2" Chlorinator <i>4.2 Lb. Capacity</i>	C1058
Hayward CL220ABG Off-Line Chlorinator <i>9 Lb. Capacity</i>	C1057
Hayward CL220 Off-Line Chlorinator <i>9 Lb. Capacity</i>	C1081
Hayward CL200 In-Line 1-1/2" Chlorinator w/ base <i>9 Lb. Capacity</i>	C1079
Hayward CL200-2S In-Line 2" Chlorinator <i>9 Lb. Capacity</i>	C1059
Hayward CL220 BR Off-Line Brominator <i>9 Lb. Capacity</i>	C1062

CHLORINE & BROMINE TABLET DISPENSERS

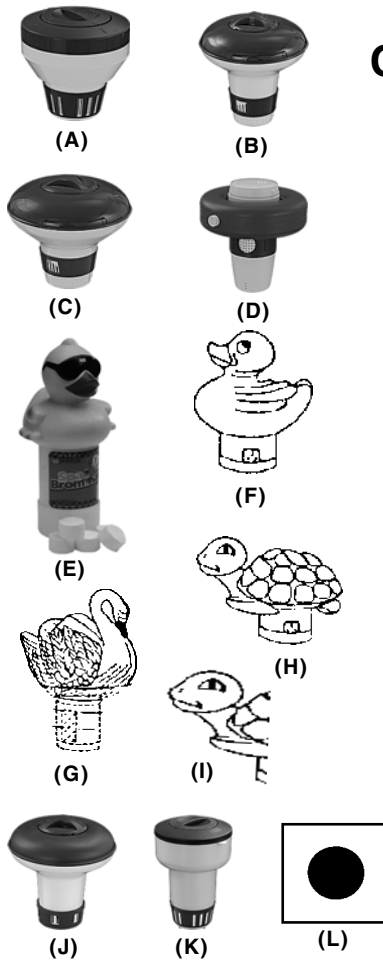

(A)	Rainbow Chlorine Dispenser #330	C1082
(B)	Chlorine Dispenser - Small (Pool Master)	C1070
(C)	Chlorine Dispenser - Large (Pool Master)	C1071
(D)	Chlorine Dispenser - Large (AllChlor)	A4882
(E)	Derby Duck - Spa/Hot Tub Brominator <i>Assorted Beak Colors</i>	B2020
(F)	Derby Duck - Spa & Small Pool <i>(Bromine Dispenser)</i>	B2030
(G)	Ducky Floating Dispenser - Yellow	C1068
(H)	Swan Chlorinator - Large	C1074
(I)	Turtle Floating Dispenser - Green	C1069
(J)	Spa Chlorine/Bromine Dispenser #335	C1063
(K)	Blue Devil - Floating Bromine	C1073+
(L)	Blue Devil Tall Chlorine Dispenser	C1072
(L)	Foam Collar for 4 Lb. Cartridge	A3938



OMNI/HYDROTECH BROMINATORS

	ITEM NO.
Brominator CR8-14 0-15,000 Gallons	A6178
Brominator CR8-19 15-25,000 Gallons	A6184
Brominator CR8-28 25-40,000 Gallons	A6177
Flowmeter* for Brominators CR8-14 thru CR8-28 <i>(*Required for NSF Listing)</i>	A6216
Quick Connect Installation Kit for CR Model Brominators	A6188



ASTRAL FEEDER

Astral In-Line Auto Feeder	C1045
Astral Off-Line Table/Stick Chemical Feeder	C1047
Astral Chlorinator Lid O-ring	C1050
<i>For Model # 24431 & 24432 #713 R 1329045</i>	



KING TECH PERFORM-MAX FEEDERS



Chlorinators & Brominators



#960



#740



#940

Perform-Max 940 In-Line Automatic Feeder <i>For In-Ground Pools 10 Lb. Capacity - 2" FPT</i>	C1278
Perform-Max 960 Off-Line Automatic Feeder <i>For In-Ground Pools 10 Lb. Capacity - 2" FPT</i>	C1279
Sani King #740 In-Line Spa Feeder	C1277

MA CHLORINATOR - NSF Listed

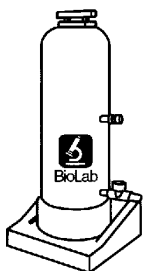

MA-18BFM Chlorinator with Flow Meter <i>Maximum Pool Size Up to 75,000 Gallon</i>	A7247
MA-35BFM Chlorinator with Flow Meter <i>Maximum Pool Size Up to 150,000 Gallons</i>	A7250
MA-48FM Chlorinator with Flow Meter <i>Maximum Pool Size Up to 600,000 Gallons</i>	A7251

RAINBOW CHLORINATOR



Rainbow Spa Feeder #302	C1080
Rainbow Auto Chlorinator #300 Off-Line <i>Holds 11 Large or 98 Small Tablets - NSF Listed</i>	C1085
Rainbow Auto Chlorinator #320 In-Line <i>Holds 11 Large or 98 Small Tablets - NSF Listed</i>	C1086
Rainbow Installation Kit for #300 & #320 Inline Chlorinators	C1054

HIGH CAPACITY CHLORINE AND BROMINE FEEDERS

	ITEM NO.
Rainbow/Pentair Auto Chlorinator #300-29X Holds 29 large or 237 small tabs <i>Treats from 80,000 up to 322,000 gallons</i>	C1040
Rainbow/Pentair Feeder Installation Kit for #300-29X High Capacity Feeder	C1055
Rainbow/Pentair Auto Chlorinator #HC-3315 For 1" hard plumbing installations. <i>Holds 15 lbs. of tabs. Treats up to 20,200 gallons w/Bromine and up to 97,600 gallons with Trichlor.</i>	C1041
Rainbow/Pentair Auto Chlorinator #HC-3330 For 1" hard plumbing installations. <i>Holds 30 lbs. of tabs. Treats up to 40,000 gallons w/Bromine and up to 160,000 gallons with Trichlor.</i>	C1042
Rainbow/Pentair Auto Chlorinator #HC-3340 For 1" hard plumbing installations. <i>Holds 40 lbs. of tabs. Treats up to 61,000 gallons w/Bromine and up to 332,000 gallons with Trichlor.</i>	C1043
Rainbow/Pentair R172082 Flow Indicator	C1039
Rainbow/Pentair RDF3607 Flow Meter .50-51gph - 1" Threaded	H7049
Rainbow/Pentair R172214 Lock ring for cartridge filters	H5469
Rainbow/Pentair R172385D Lid w/O-Ring for high capacity auto feeders.	C1044
Rainbow/Pentair R172240 Lid O-Ring (only) for high capacity auto feeders.	C1046
Rainbow/Pentair R175251 Screen for high capacity auto feeders.	C1048
Rainbow/Pentair R172435 Ball check for high capacity auto feeders.	C1049
Rainbow/Pentair R172375 Lock Screw	C1056
Rainbow/Pentair R172374 Lock Spring	H5489

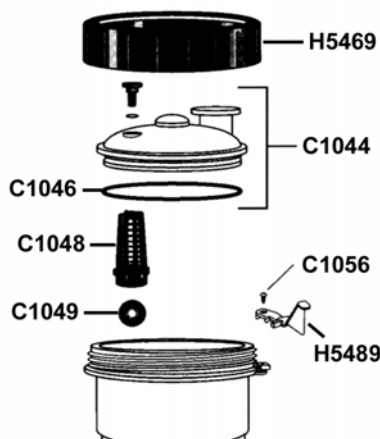

BLUE WHITE PERISTALTIC INJECTOR PUMPS A-100 FLEXFLO PUMP

Solid-state feed control & chemical resistant all-plastic housing. A-100 units have an integral 60 second feed controller. Dual running lights indicate when the unit is energized, and when it is in the running portion of the time cycle.



GALLONS PER DAY	MODEL NO.	DESCRIPTION	TUBING	ITEM NO.
6	114-4	Blue-White Chlorinator	1/4" Tubing	C1019+
22	114-6	Blue-White Chlorinator	3/8" Tubing	C1020+

+Limited Stock

+A-100 series pumps have been discontinued - Limited Supply Available

Parts for A-100 Chlorinators



Injection Check Valve

A-014HD-4A	Anti-Syphon 1/4" Injection Check Valve (Heavy Duty)	C1411
A-014HD-6A	Anti-Syphon 3/8" Injection Check Valve (Heavy Duty)	C1407

Threadless
Injector Fitting

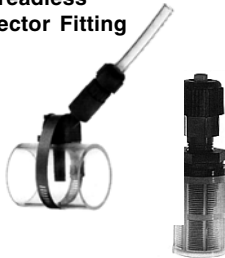

Foot Valve/Strainer

A-002-4	Pump Tubing Assembly	1/4"	C1401
A-002-6	Pump Tubing Assembly	3/8"	C1400
A-002-7	Pump Tubing Assembly	7/16"	C1418
A-002-6N	Neoprene Tubing Assembly	3/8"	C1410
A-002-7N	Neoprene Tubing Assembly	7/16"	C1417
	Threadless Injector Fitting	1-1/4" - 2" x 3/8"	C1432
	Threadless Injector Fitting	1-1/4" - 2" x 1/4"	C1433
	Threadless Injector Fitting	2-1/2" x 3/8"	C1434
	Threadless Injector Fitting	3" x 3/8"	C1436
	Threadless Injector Fitting	4" x 3/8"	C1438
	Threadless Injector Fitting	6" x 3/8"	C1440
	Threadless Injector Fitting	8" x 3/8"	C1442
C-340N-6V	Foot Valve/Strainer for 3/8" Tubing		C1450
C-346	Ceramic Weight		C1470



BLUE-WHITE
INDUSTRIES

FLEXFLO A-100N SERIES HIGH PRESSURE CHLORINATORS

Equipped with solid state percentage timer with dial type feed adjustment. Operates under Higher Pressure up to 100 PSI. Self-priming, even against line pressure. Offers fast, convenient tube changes with no valves or seals. Long Tube Life.



Digital Models
Available by
Special Order
- Add \$50

GALLONS PER DAY	MODEL NO.	DESCRIPTION	ITEM NO.
6.8	A1N00A-6T	Blue-White High Pressure Chlorinator	C1021
9.5	A-1N30A-4T	Blue-White High Pressure Chlorinator	C1018
16.0	A1N10A-6T	Blue-White High Pressure Chlorinator	C1023
24.0	A1N20A-6T	Blue-White High Pressure Chlorinator	C1025
30.1	A1N30A-6T	Blue-White High Pressure Chlorinator	C1027
52.5	A1N10A-7T	Blue-White High Pressure Chlorinator	C1029
76.1	A1N20A-7T	Blue-White High Pressure Chlorinator	C1031
95.1	A1N30A-7T	Blue-White High Pressure Chlorinator	C1033

Parts for A-100N Series

A-002N-4T	1/4 Pump Tube Assy. - 3/8" Tube Nut Connection	C1444
A-002N-6T	3/8 Pump Tube Assy. - 3/8" Tube Nut Connection	C1445
A-002N-7T	7/16 Pump Tube Assy. - 3/8" Tube Nut Connection	C1443
A-002N-6Q	3/8 Pump Tube Assy. - 3/8" Quick-Connect	C1447
A-002N-4Q	1/4 Pump Tube Assy. - 3/8" Quick-Connect	C1446

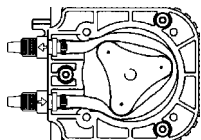

ROLA-CHEM CHLORINATORS

Pro-Series with Plastic Construction
One Year Limited Warranty



GALLONS PER DAY	MODEL NO.	DESCRIPTION	ITEM NO.
9.6	RC-25/50	Rola-Chem Chlorinator	C1001
40.0	RC-103 SC	Rola-Chem Chlorinator	C1000
80.0	RC-503 SC	Rola-Chem Chlorinator	C1007

Parts for Rola-Chem Chlorinators

Silicone Feed Tube R-115S	(523115)	C1010
Plastic Injection Fitting Assembly	(527159)	C1379
E-Z Glide Silicone Lubricant	(523102)	C1011
Hose Weight	(523110)	C1318
Brass Injector	(527158)	C1373



STENNER CHLORINATORS



Peristaltic Chemical Feeders

A high quality, rugged chemical feeder highly resistant to the most corrosive chemicals. Stenner chlorinators are self-priming & feature mechanical control with peristaltic action for precise outputs. For ease of maintenance or replacement, all major feeder components can be easily disassembled without using tools.

Fixed Feed Rate

GALLONS PER DAY	Model	Accessories	Item No.
22*	Stenner Model 45M3	(#3 Tube Size) with 1/4" Accessories	C1385

Adjustable Feed Rate Controls

2.5 to 50*	45M5	(#5 Tube Size) with 1/4" Accessories	C1383
2.5 to 50*	45M5	(#5 Tube Size) with 3/8" Accessories	C1900
4.3 to 85*	85M5	(#5 Tube Size) with 1/4" Accessories	C1384
4.3 to 85*	85M5	(#5 Tube Size) with 3/8" Accessories	C1902
5.0 to 100	100DM5 Double Head	(#5 Tube Size) with 3/8" Accessories	C1904
8.5 to 170	170DM5 Double Head	(#5 Tube Size) with 3/8" Accessories	C1906

*Feeder output may be reduced by replacing pump tube with smaller size

Tube Assemblies For Stenner Feeders



#1 Replacement Tube Assembly with Ends	(Pkg. of 2)	UCCP201	C1915
#2 Replacement Tube Assembly with Ends	(Pkg. of 2)	UCCP202	C1916
#3 Replacement Tube Assembly with Ends	(Pkg. of 2)	UCCP203	C1917
#4 Replacement Tube Assembly with Ends	(Pkg. of 2)	UCCP204	C1918
#5 Replacement Tube Assembly with Ends	(Pkg. of 2)	UCCP205	C1920
Injector 1/4"	(Pkg. of 1)	UCDBINJ	C1921
Injection FTG	(Pkg. of 1)	UCAK300	C1930
1/4" Check Valve Kit	(Pkg. of 1)	MCDBKIT	C1978+

+Limited Stock

CHEM TECH FEEDERS

Series 100 & 200



A Reliable and Durable, H. D. Diaphragm Feed Pump with a Fully Adjustable Feed Rate Control. Provides Excellent efficiency under Strenuous Conditions. Built for Long Life.

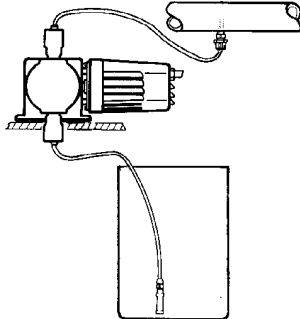

GALLONS PER DAY	DESCRIPTION	ITEM NO.
7	Model 007 Chem-Tech Feeder <i>Uses 1/2" OD Tubing</i>	100 psi D4202+*
30	Model 030 Chem-Tech Feeder <i>Uses 1/2" OD Tubing</i>	100 psi D4218+*
40	Model 240 Chem-Tech Feeder <i>Uses 1/2" OD Tubing</i>	125 psi D4205*
60	Model 260 Chem-Tech Feeder <i>Uses 1/2" OD Tubing</i>	125 psi D4210*
120	Model 2-120 Chem-Tech Feeder <i>Uses 1/2" OD Tubing</i>	80 psi D4215+*

+Limited Stock
*Non-Stock Item

Parts for Chem Tech Feeders

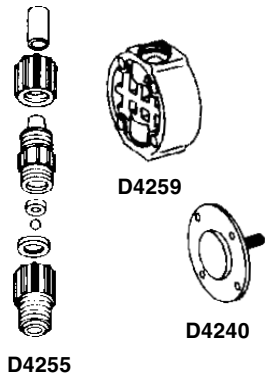

Complete Head Assy. (Series 100/200)	28903	(A51P)	D4245
KOP Kit: Includes All Wet End Parts			D4350
Acrylic Head Only	J28800	(242P)	D4259
Valve Housing	41540	(244P)	D4230
Injector Fitting w/ Check Valve Assy.	J41658	(A52P)	D4255
Anti-Siphon Valve Assy.	41624		D4260
Diaphragm, Hypalon	25704	(228P)	D4240
Foot Valve and Strainer Assy.	J40117	(A50P)	D4250
Coupling Nut	J24960	(240P)	D4272
Chlorinator Oil for Misc. Chemical Feeders - Quart			D1050

LMI BRAND METERING PUMPS & PARTS AVAILABLE ON SPECIAL ORDER BASIS

STORAGE VATS

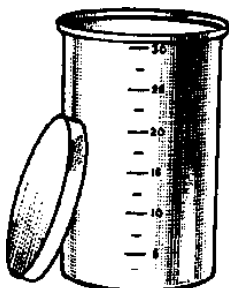

50 Gallon Storage Vat with Lid	D1058
Lid Only for 50 Gallon Vat	D1059
50 Gallon Vat Only	D1060
150 Gallon Storage Vat with Lid	D1061
Lid Only for 150 Gallon Vat	D1062
150 Gallon Vat Only	D1063
50 Gallon Containment Tank	D1065

Poly and Clear Vinyl Tubing Sizing Guide

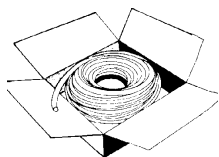

POLYETHYLENE TUBING

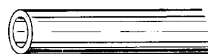

Size	OD	Description	ITEM NO.
1/4"	OD	Poly Tubing x 100' Coil	C1110
		Cut per Ft.	C1102
5/16"	OD	Poly Tubing x 100' Coil	C1117
		Cut per Ft.	C1109
3/8"	OD	Poly Tubing x 100' Coil	C1112
		Cut per Ft.	C1104
3/8"	OD	Poly Tubing x 100' Coil	C1113
		Color:Black Cut per Ft.	C1105
1/2"	OD	Poly Tubing x 100' Coil	C1114
		Cut per Ft.	C1106
5/8"	OD	Poly Tubing x 100' Coil	C1116
		Cut per Ft.	C1108

CLEAR VINYL TUBING

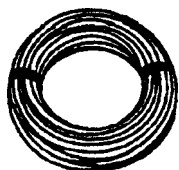

1/4"	OD	Clear Vinyl Tubing x 100' Coil	C1118
		Cut per Ft.	C1119
5/16"	OD	Clear Vinyl Tubing x 100' Coil	C1130
		Cut per Ft.	C1120
3/8"	OD	Clear Vinyl Tubing x 100' Coil	C1132
		Cut per Ft.	C1122
7/16"	OD	Clear Vinyl Tubing x 100' Coil	C1134
		Cut per Ft.	C1124
1/2"	OD	Clear Vinyl Tubing x 100' Coil	C1136
		Cut per Ft.	C1126
5/8"	OD	Clear Vinyl Tubing x 100' Coil	C1138
		Cut per Ft.	C1128

MISC. FITTINGS FOR POLY AND VINYL TUBING

Compression Male Adapter

1/4"	MPT x Tubing		C1090
3/8"	MPT x Tubing		C1095
1/2"	MPT x Tubing		C1100
1/4"	MPT x 1/2" Tube Coupling		C2001
1/8"	MPT x 3/8" Tube Coupling		C2002
1/4"	MPT x 3/8" Comp MA		C2003
1/4"	MPT x 1/4" Comp 90 Deg El		C2004
1/4"	MPT x 3/8" Comp 90 Deg El		C2005

Seal x Seal

3/8" x 3/8"	90 Deg Elbow (Kynar)		C2006
3/8" x 3/8" x 3/8"	Tee (Kynar)		C2007
3/8" x 3/8" x 1/4"	Tee		C2008
3/8"	90 Deg w/ 1/4" Swivel		C2009
3/8"	Tee w/ 1/4" Swivel		C2010
3/8"	Coupling		C2011
3/8"	Thru Wall Coupler		C2012

Seal x Thread

1/4"	MPT x 3/8" Seal 90 Deg El		C2013
1/4"	MPT x 3/8" Seal MA		C2014

Ins x Ins

1/4" x 3/8"	ID Tee		C2015
3/8"	ID Coupling		C2016

Valves

1/4"	MPT x 3/8" Seal 90 Deg		C2020
1/4"	FPT x 3/8" Seal Straight		C2021
1/8"	MPT x 1/8" FPT Straight		C2022
1/4"	MPT x 1/4" FPT		C2023
1/4"	FPT x 1/4" FPT		C2024
1/4"	FPT x 1/4" FPT Ball Valve		C2329

FOR CAT FLOW CELL

Tubing Cutter			V7013
---------------	--	--	-------

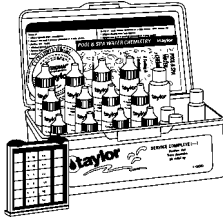
Silver Lake WaterSafe Rapid Bacteria Test Kit*An antibody-based rapid test kit for the presence of bacteria in water.*ITEM NO.
B1600

2000 SERIES TEST KITS

Complete Pool/Spa Service

K-2005 High

A complete DPD test kit designed for service people, commercial pool operators & health officials interested in economy & portability. Tests for: chlorine (0.5 - 5 ppm) Bromine (1.0 - 10 ppm) pH (7.0 - 8.0 ppm) acid/base demand, hardness, alkalinity & cyanuric acid. Uses 3/4 Oz. reagents.

B1085

K-2005-C

Same as above except with 2 Oz. Reagents.

B1081

K-2006

The same complete DPD test kit as the K-2005, but uses titration tests to eliminate color-matching problems. (1 drop = 0.2 or 0.5 ppm) Free & Combined Chlorine

B1089

K-2006-C

Same as above except with 2 Oz. Reagents

B1078

K-2015 High

A "Test 4" series DPD test kit for: Free and Total Chlorine (0.5 - 5 ppm), Bromine (1.0 - 10 ppm), pH (7.0 - 8.0 ppm) Acid / Base Demand and Total Alkalinity.

B1082

K-2000 High

A basic starter kit that tests for: chlorine (0.5 - 5 ppm) bromine (1.0 - 10 ppm) pH (7.0 - 8.0 ppm) acid/base demand. Uses 3/4 Oz. reagents.

B1080

K-2100 Low

A basic starter kit that tests for: chlorine (.25 - 2.5 ppm) bromine (.5 - 5 ppm) pH (7.0 - 8.0 ppm) acid/base demand. Uses 3/4 Oz. reagents.

B1090



COMMERCIAL SERIES

Slide Comparators

K-1765

Liquid DPD test kit utilizing slide comparators for accurate & easy measurements

B1074

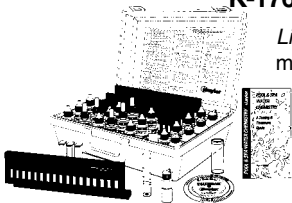





PROFESSIONAL SERIES

Complete Field Lab

K-1741-C

A portable & most accurate test kit with slides & 2 Oz. reagents. Tests for low chlorine (0 - 3.0 ppm) high chlorine (1.0 - 10 ppm) pH (6.8 - 8.4 ppm) acid & base demand, total alkalinity, calcium hardness, total hardness, cyanuric acid, copper & iron.

B1076

		SIZE	REAGENT NO.	ITEM NO.
	#1 DPD Reagent Solution	3/4 Oz. (22 ml)	R-0001-A	B1171
		2 Oz. (60 ml)	R-0001-C	B1139
	#2 DPD Reagent	3/4 Oz. (22 ml)	R-0002-A	B1172
		2 Oz. (60ml)	R-0002-C	B1141
	#3 DPD Reagent	3/4 Oz. (22 ml)	R-0003-A	B1173
		2 Oz. (60 ml)	R-0003-C	B1143
	#4 pH Indicator Solution (Phenol Red)	3/4 Oz. (22ml)	R-0004-A	B1174
		2 Oz. (60ml)	R-0004-C	B1133
		16 Oz. (480 ml)	R-0004-E	B1135
		1 Gal. Bottle	R-0004-G	B1240
	#5 Acid Demand Reagent (ADR)	3/4 Oz. (22ml)	R-0005-A	B1175
		2 Oz. (60ml)	R-0005-C	B1212
	#6 Base Demand Reagent (BDR)	3/4 Oz. (22ml)	R-0006-A	B1176
		2 Oz. (60ml)	R-0006-C	B1169
	#7 Thiosulfate Solution N/10	3/4 Oz. (22ml)	R-0007-A	B1177
		2 Oz. (60ml)	R-0007-C	B1195
	#8 Total Alkalinity Indicator	3/4 Oz. (22ml)	R-0008-A	B1178
		2 Oz. (60ml)	R-0008-C	B1203
	#9 Sulfuric Acid .12N	3/4 Oz. (22ml)	R-0009-A	B1179
		2 Oz. (60ml)	R-0009-C	B1204
	#10 Calcium Buffer	3/4 Oz. (22ml)	R-0010-A	B1180
		2 Oz. (60ml)	R-0010-C	B1250
		16 Oz. (480ml)	R-0010-E	B1205
	#11 Calcium Indicator Solution	3/4 Oz. (22ml)	R-0011-A	B1181
		2 Oz. (60ml)	R-0011-C	B1190
		10 Gram Powder	R-0011-P-I	B1196
	#12 Hardness Reagent	3/4 Oz. (22ml)	R-0012-A	B1182
		2 Oz. (60ml)	R-0012-C	B1251
	#13 Cyanuric Acid Reagent	2 Oz. (22ml)	R-0013-C	B1183
		16 Oz. (480ml)	R-0013-E	B1238
		1 Gal. Bottle	R-0013-G	B1207
	Phenol Red pH Indicator	3/4 Oz. (22ml)	R-1003J-A	B1134
		2 Oz. (60ml)	R-1003J-C	B1131
		16 Oz. (480ml)	R-1003J-E	B1136
		32 Oz. (960ml)	R-1003J-F	B1138
	Phenol Red (Residential Series) OTO Orthotolidine	3/4 Oz. (22ml)	R-0014-A	B1168
		3/4 Oz. (22ml)	R-0600-A	B1132
		16 Oz. (480ml)	R-0600-E	B1137
	Copper Reagent #1	3/4 Oz. (22ml)	R-0860-A	B1192
	Copper Reagent #2	3/4 Oz. (22ml)	R-0861-A	B1193
	Iron Reagent #1	3/4 Oz. (22ml)	R-0851-A	B1197
	Iron Reagent #2	3/4 Oz. (22ml)	R-0852-A	B1199
	Acid Demand	2 Oz. (60ml)	R-0853-C	B1257
	Base Demand	2 Oz. (60ml)	R-0862-C	B1259
	DPD Powder	10 Gram Bottle	R-0870-I	B1261
	DPD Powder	.25 Lb. Bottle	R-0870-J	B1260
	Total Hardness	3/4 Oz. (22ml)	R-854-A	B1262
	FAS-DPD (Chlorine) Titrating Reagent	2 Oz. (60ml)	R-0871-C	B1268
	FAS-DPD (Bromine) Titrating Reagent	2 Oz. (60ml)	R-0872-C	B1191
	Reagent Pack, Deox Reagent (monopersulfate)	3/4 Oz. (22ml)	K-2041	B1266
	Reagent Pack, Deox Reagent (monopersulfate)	2 Oz. (60ml)	K-2042	B1267
	TDS Resin		R-809-II	B1269



COPPER TEST KIT



SPECIALTY TEST KITS

Taylor K-1738 Copper Test Kit (0.2 - 3.0 ppm) B1098

Taylor K-1716 Iron Test Kit (0 - 2.0 ppm) B1095

Taylor K-1518 Chlorine & Monopersulfate B1071

Tests for Chlorine (free, combined & total) plus test to distinguish monopersulfate shock.

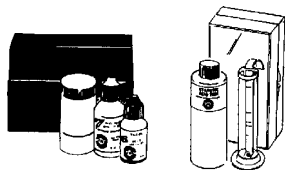

#1200 WATER HARDNESS TEST KIT

#79 CYANURIC ACID TEST KIT

Rainbow #79 Cyanuric Acid Test Kit 8 Oz. B1045

Case of 6

Rainbow #1200 Water Hardness Test Kit B1006

Rainbow #1300 Alkalinity Test Kit B1060

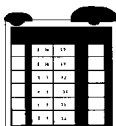

COMPONENTS FOR TAYLOR TEST KITS

Replacement Block - (2000 Series) Chlorine/Bromine (High) #9056 B1210

Replacement Block - (2000 Series) Chlorine/Bromine (Low) #9057 B1211

Replacement Cap - (2000 Series) Large Cell #3012 B1247

Replacement Cap - (2000 Series) Small Cell #3013 B1248

Replacement Slide - Chlorine DPD (1.0 - 10 ppm) #9083 B1263

Replacement Slide - Chlorine DPD (.0 - 3.0 ppm) #9082 B1252

Replacement Slide - Bromine DPD (2.0 - 10 ppm) #9236 B1264

Replacement Slide - pH Phenol Red (6.8 - 8.4 ppm) #9067 B1189

Lucite Cell #4024 B1142

Lucite Cell For 1744TK #4025 B1140

5 ml Pipette #4028 B1144

Poly Bottle .75oz #2146 B1215

Test Cell CYA View, (20 - 80 ppm) 2000 Series #9193 B1184

Watergram #6026 B1265

Booklet, Pool & Spa Water Chemistry #2004B B1218

15 ml. Bottle for CYA Dispenser #9194 B1249

Sample Tube #9198 B1233

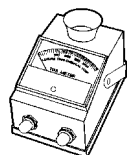
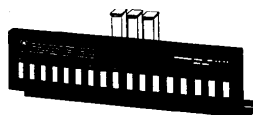

TDS METER

TDS Meter - Myron L (0 - 5,000 ppm) B1430

Compact instrument quickly determines parts per million (ppm) of Total Dissolved Solids of almost any solution.

DIGITAL POCKET TESTERS

TDS Meter -Pocket Size Tester (1,990 ppm) Primo B1432

Lightweight, rugged, waterproof housing with pocket clip

pH Meter - Pocket Size Tester (0-14 pH) pHEP 4 B1433

Automatic, accurate tester in protected waterproof housing

Buffer Solution for pH Calibration #7HI-7007 (230 ml) B1431

Calibration Solution for TDS Meter HI-7032P (30 ml) B1434

Hanna Instruments #98121 - pH, orp, temp tester B1435

Hanna Instruments #98311 - TDS meter B1436

Hanna Instruments #93717 - Phosphate meter B1437

Hanna Instruments #93717-01 - Reagent for phosphate meter B1438

Hanna Instruments #70007P - pH 7.01 SAC B1439



RESIDENTIAL TEST KITS



#576A



#22260



#HR78



#756



#0140



sureTrack-4

		ITEM NO.
Aquality #576A Duo Test Kit	12/Cs.	B1000
<i>Tests for chlorine & pH</i>		
Poolmaster #22244 Dual Test Kit	Each	B1004
Poolmaster #22260 Basic Four Test Kit	12/Cs.	B1009
<i>Tests for Cl, pH, alkalinity & acid demand</i>		
Rainbow #HR78 All-In-One Test Kit	12/Cs.	B1010
<i>Tests for Cl, pH, alkalinity & acid demand</i>		
Rainbow #78 DPD Tablet Test Kit	12/Cs.	B1017
<i>Tests free, total, combined Cl, pH, acid demand & TA.</i>		
Rainbow #78 HR DPD Plus Tablet Test Kit	Each	B1019
<i>Tests free, total, combined Cl, pH, acid demand & TA.</i>		
Rainbow #756 DPD Bromine Test Kit	24/Cs.	B1034
<i>Tests for bromine & pH (OTO & pH solutions)</i>		
Taylor sureTRACK-4 Test Strips	Each	B1500
<i>Tests for free chlorine or bromine, pH & total alkalinity (50 strips per bottle)</i>		
AQUA TREND 2-WAY OTOTEST KIT	Each	B1460
Ocean Blue 3 Way Test Strips	Each	B1425
<i>Tests for free chlorine, pH & total alkalinity (50 strips per bottle)</i>		
Taylor #0140 Trouble Shooter Test Kit	12/Cs.	B1069
<i>Tests for chlorine, bromine, alkalinity & pH w/acid demand</i>		

REPLACEMENT SOLUTIONS

	ITEM NO.
Aquality 1 Oz. Phenol Red	B1111+
Aquality 1 Oz. #2 Alkalinity	B1113+
Aquality 1 Oz. #2 Hardness	B1115+
#3 Mark IV Solution 1 Oz.	B1163+
#5 Mark IV Solution 1/2 Oz.	B1167+
	+Limited Stock



	POOLMASTER	RAINBOW
Card of 5 Btl. Solutions	B1105	B1104
#1 OTO1 Oz.	B1220	B1110
#2 pH Solution 1 Oz.	B1222	B1112
#3 Acid Demand 1 Oz.	B1224	B1114
#4 Alkalinity 1/2 Oz.	B1228	B1118
#5 Neutralize 1/2 Oz.	B1226	B1116
Rainbow 3/4 Oz. OTO		B1101
Rainbow 3/4 Oz. Phenol Red		B1103
Rainbow 3/4 Oz. OTO & Phenol Red		B1106
	<i>Carded Reagents</i>	24/Cs.
Poolmaster 1/2 Oz. OTO		B1223
Poolmaster 1 Oz. OTO & pH		B1102
	<i>Carded Reagents</i>	12/Cs.

BULK SOLUTIONS

Rainbow Cyanuric 4 Oz. Btl.	B1145
Rainbow Cyanuric 8 Oz. Btl.	B1146
Poolmaster Cyanuric 8 Oz. Btl.	B1221



WATERLINK EXPRESS

Special Order Only

A WATER TEST SYSTEM WHICH USES INDIVIDUAL DOSE VIALS (UDVS) AND COMPLETELY ELIMINATES REAGENT ADDITIONS, TITRATIONS AND TIME CONSUMING CLEAN UP PROCEDURES.



WaterLink Express System - Complete

ITEM NO.
B1704*

*Includes: Colorimeter, 100 UDVs per test factor, acid/base dropper bottles, lab pipettor, two 42 vial racks, wall banner & diagrammed instruction card.
(Computer & software not included)*

Express Datamate Software 7.1 (Compact Disk)

B1707*

Dose Vials for Water Link Express

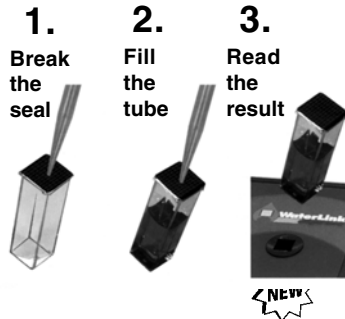

Free Chlorine UDV	(Box of 50)	B1773*
Total Chlorine UDV	(Box of 50)	B1774*
pH - Phenol Red UDV	(Box of 50)	B1772*
Total Alkalinity UDV	(Box of 50)	B1770*
Calcium Hardness UDV	(Box of 50)	B1771*
Cyanuric Acid UDV	(Box of 50)	B1775*
Copper UDV	(Box of 50)	B1776*
Iron UDV	(Box of 50)	B1777*

POOL MGR. TEST KIT

LaMotte Pool MGR. Tablet Test Kit 3363-NJ/PM-3-NJ B1711

Free chlorine 0.5-10.0, total chlorine 0.5-10.0 & pH 6.8-8.2

LaMotte 5 & 10 ml Octaslide Tube (Replaces B1754) B1750*

LaMotte DPD Tablet Test Kit 3302 B1700*

*Special Order Only

DPD TEST TABLETS



DPD #1 Test Tablets	(Bag of 100)	B1124
DPD #3 Test Tablets	(Bag of 100)	B1125
Phenol Red Test Tablets	(Bag of 100)	B1126
Calcium Hardness Test Tablets	(Bag of 100)	B1420
Alkalinity Test Tablets	(Bag of 100)	B1421
Cyanuric Acid Test Tablets	(Bag of 100)	B1422

LAMOTTE TEST STRIPS



	ITEM NO.	
LaMotte Insta-Test 3 Test Strips	100 Btls./Case	B1735
Tests for free chlorine or bromine, pH & alkalinity		
LaMotte Insta-Test 3	12 Pack with Display Tray	B1728
LaMotte Insta-Test 5-N-1 Test Strips	12 Btls./Case	B1725
Tests for free & total chlorine, pH, alkalinity & hardness.		
LaMotte Insta-Test Pro-400 (Service Man)	12 Btls./Case	B1726
Tests for free & total chlorine, bromine, alkalinity & pH		
Copper Iron Test Strips	12 Btls./Case	B1736
Cyanuric Acid Test Strips	12 Btls./Case	B1740
Sodium Chloride (Salt) Test Strips	12 Btls./Case	B1734

AquaChek™

Test Strips for Pool, Spa, or Pond



		PACKING	ITEM NO.
AquaChek Pro	(100 Strips/Bottle)	12 Btl./Case	B1415
<i>1-Dip Test for Free Chlorine, Total Chlorine, Total Alkalinity pH & Total Bromine</i>			
AquaChek Yellow 4 in 1 Test	(50 Strips/Bottle)	12 Btl./Case	B1400
<i>1-Dip Test for Free Chlorine, Total Alkalinity, pH, & Cyanuric Acid</i>			
AquaChek Yellow 4 in 1 Test	(10 Strips/Bottle)	12 Btl./Case	B1423
<i>1-Dip Test for Free Chlorine, Total Alkalinity, pH, & Cyanuric Acid</i>			
AquaChek Red 4 in 1 Test	(50 Strips/Bottle)	12 Btl./Case	B1402
<i>1-Dip Test for Total Bromine, pH Balance & Total Alkalinity</i>			
AquaChek Select 5 in 1 Test	(50 Strips/Bottle)	6 Btl./Case	B1401
<i>1-Dip Test for Total Chlorine, Free Chlorine, Total Hardness pH Balance & Total Alkalinity</i>			
AquaChek Select Refill Kit	(50 Strips/Bottle)	6 Btl./Case	B1403
<i>Includes Color Chart & Test Log</i>			
AquaChek Silver 7 in 1 Test	(100 Strips/Bottle)	6 Btl./Case	B1404
<i>1-Dip Test for Total Chlorine, Free Chlorine, Total Hardness, pH Balance, Total Alkalinity, Cyanuric Acid & Total Bromine</i>			
AquaChek Monopersulfate	(50 Strips/Bottle)	12 Btl./Case	B1413
<i>Tests for Potassium Monopersulfate, pH & Total Alkalinity</i>			
AquaChek Green Stabilizer Test	(25 Strips/Bottle)	6 Btl./Case	B1405
<i>1-Dip Test for Cyanuric Acid Stabilizer</i>			
AquaChek TDS	(25 Strips/Bottle)	6 Btl./Case	B1426
<i>Tests for Total Dissolved Solids (TDS)</i>			
AquaChek Orange Total Hardness	(25 Strips/Bottle)	6 Btl./Case	B1412
<i>1-Dip Test for Total Hardness</i>			
AquaChek Blue 3 in 1 Test	(25 Strips/Bottle)	12 Btl./Case	B1409
<i>Tests for Biguanide, pH Balance, Total Alkalinity</i>			
AquaChek White Salt Test	(10 Strips/Bottle)	12 Btl./Case	B1411
<i>Tests for Salt (Sodium Chloride & Sodium Bromide)</i>			
AquaChek Pink Nitrate Test	(25 Strips/Bottle)	6 Btl./Case	B1406
<i>1-Dip Test for Nitrate</i>			
AquaChek Copper Test	(25 Strips/Bottle)	6 Btl./Case	B1417
<i>1-Dip Test for Total Copper Levels</i>			
AquaChek Iron Test	(25 Strips/Bottle)	6 Btl./Case	B1418
<i>Tests for Total Iron Levels</i>			
AquaChek Pond Test	(25 Strips/ Bottle)	6 Btl./Case	B1414
<i>Tests for pH, Buffering Capacity, Nitrite & Nitrate</i>			
AquaChek Pond Test	(25 Strips/Bottle)	6 Btl./Case	B1416
<i>Tests for Total Ammonia Levels</i>			

THERMOMETERS

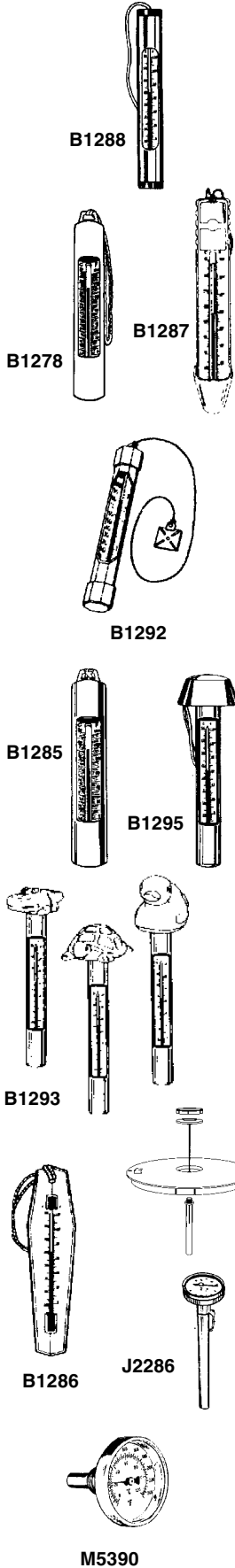

		PACKING	ITEM NO.
Chrome/Brass Thermometer	25288	12/Case	B1288
Chrome Thermometer	25288	12/Case	Y3273
Clear-View Chrome	25290	12/Case	B1278
Deluxe w/Water Pocket	25287	12/Case	B1287
Jumbo Jim Thermometer	AQ2024	12/Case	B1291
Jumbo Black Thermometer	25292	12/Case	B1292
Plastic Tube Thermometer	25285	12/Case	B1285
Plastic Tube Thermometer Various Colors	25385	12/Case	B1280
Floating Thermometer	25295	12/Case	B1295
Chrome Thermometer (Swimline)	9205	12/Case	Y3273
Floating Thermometer (SwimLine)	9210	12/Case	Y3274
Floating Premier Digital Thermometer	2530	12/Case	B1294
Basic Animal Floating Thermometer	9210	12/Case	B1296
Basic Floating Thermometer	18307	12/Case	B1297
Floating Animal Heads Alligator, Turtle & Duck	25296	12/Case	B1293
Round Floating Thermometer Whale, Turtle, Duck & Boat	WP-144	12/Case	B1301
ThermoDuck Thermometer Great American Duck	7000	24/Case	B2025
Standard Economy	25286	12/Case	B1286
Skimmer Lid w/ 3" Thermometer- White		12/Case	B1305
<i>Fits Swimquip & Jacuzzi Skimmers - Tan</i>		12/Case	B1310
Skimmer Lid w/ 3" Thermometer - L3			B1315
<i>Fits Hayward Square Lid Skimmers</i>			
Skimmer lid w/ 3" ThermometerL4			B1320
<i>Fits American Products Skimmers</i>			
Replacement SKR Thermometer, Tube & Bushing			B1325
Replacement SKR Thermometer Only			B1324
In-Line Thermometer (3" Long w/1/2" MPT Well)			M5390
Replacement Nylon Well for Thermometer			B1326
Pocket Thermometer (Laars R0336000)			J2286
<i>w/ Pete's Plug & 1/2" Bushing</i>			



Not All Items In Stock

Residential Cleaners



MakoShark

MakoShark (Aqua Vac 1500) with 55' Cord
for Concrete or Vinyl Pools

ITEM NO.
E3005

A lightweight powerful pool cleaner self-equipped with velcro sealed filtration bags. Sucks up leaves, debris & gravel. Able to clean residential pool in less than 90 minutes.



TigerShark

TigerShark with 55' Cord

E3016

Most advanced robot cleaner with on-board computer. Reads pool contours & directs most effective cleaning program across bottom & walls right up to the waterline. Two year warranty.

All Units
Made
in USA

Commercial Cleaners

Non-Stock-Special Order- Add Freight



KingShark

TigerShark 2 with 100' Cord & Caddy Cart
for 30' x 60' and Smaller Pools

E3518

Most advanced robot cleaner with on-board computer. Reads pool contours & directs most effective cleaning program across bottom and walls right up to the waterline. Two Year Warranty.

KingShark (Aqua Prince) with 100' Cord
for 30' x 60' and Smaller Pools

E3008

Smaller commercial unit equipped with easy to clean filters. Fully automatic, completely self-contained and will clean pools up to 30' x 60' in less than three hours. Plugs into GFCI outlet.



KingShark 2

KingShark 2 (Aqua King) with 150' Cord
for 30' x 60' and Larger Pools

E3517

Includes all the standard features of the Aqua King LP along with twister cord swivel. Will completely clean an Olympic size pool in under five hours.



KingShark 2 Plus

KingShark 2 Plus (Aqua King Commander)

E3497

with 150' Cord for 30' x 60' and Larger Pools. Includes caddy cart, remote control & timer. It is fully automatic & will completely clean an Olympic size pool in under five hours. Also allows quick spot cleaning before a big event.

Accessories for Cleaners

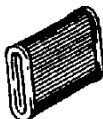

E3012

Caddy Cart for Prince, Queen & 1500 Unit

E3011*

Hoist for King & King Commander

E3515*

Repl. Filter Cartridge Only (Fits Queen/King #7807)

E3012 Sold in Pairs

Repl. Filter Cartridge Only (Fits Prince #7807L)

E3013 Sold in Pairs

Repl. Filter Cartridge Only (Tiger Shark set of 2)

E3014 Sold in Pairs

*Non-Stock Item

AQUAPRODUCTS®

Non-Stock-Special Order - Add Freight

Not all Aqua Products Included in our Catalog- Call w/Model Needed

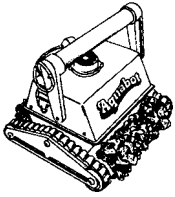

Aquabot

Pool cleaning robot designed for residential swimming pools up to 20' x 40' size. Unit does not require installation. Place in pool, plug in cord & cleaner automatically scrubs, vacuums & filters debris from bottom & walls.

ITEM NO.
E7000

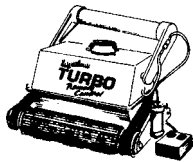

Aquabot Turbo

Designed to clean residential pools up to 20' x 50'. Aquabot Turbo incorporates a faster & more powerful motor for faster pool cleaning. Requires no special installation.

E7002

Aquabot Turbo with Remote Control

Designed to clean pools up to 30' x 60'.

E7008*

Commercial Cleaners

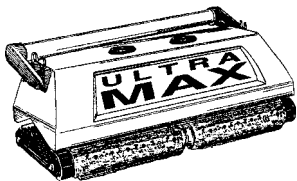

Ultra Max

Technologically advanced, easy-to-use, commercial pool cleaner. Just place lightweight unit (no hoist required) & plug in the power supply. Use either wireless or on-board microprocessor guide for fully automatic cleaning cycle. Features on-board filter system.

E7010*

Cleans 12,500 Sq. Ft. per hour 120' Cord



Ultra Max - Infra Red

Same as above unit but also equipped with Infrared obstacle avoidance system. Senses walls, ladders, etc. & reverses direction without wasting time.

E7012*

Ultra Max Junior

Smaller than Ultra Max, but with same features. Cleans 8,000 Sq. Ft. per hour. 120' Cord.

E7016*

DOLPHIN ROBOTIC POOL RESIDENTIAL CLEANERS



Multi-Cleaning System

Non-Stock Special Order- Add Freight

Climbs walls, scrubs waterline, vacuums & filters water
Operates independently of pool pump & filter.



Dolphin Diagnostic Robotic Pool Cleaner

for pool sizes up to 20' x 40'

E9000*

Dolphin Dynamic Robotic Pool Cleaner

Complete w/Remote Control & Caddy Cart
for pool sizes up to 20' x 40'

E9002*



Robo-Kleen Robotic Cleaner for Above Ground

for Pools up to 31' Round or 21' x 41' Oval

E9004*





DOLPHIN CLEANERS

Commercial Cleaners



- Dolphin Diagnostic 3001
- Dolphin Diagnostic 3002 with Remote
- Dolphin HD Commercial Cleaner

- ITEM NO.
- E9008+
- E9010+
- E9006*

Residential Cleaners

- Smart Pool IDN Sprite Residential Cleaner

- E9012+

**Non-Stock Item
+Limited Stock*



ZODIAC G4 IN-GROUND POOL SUCTION CLEANER

Features Advanced Design, Easy to Install with Low Maintenance

- Zodiac G4 Pool Cleaner

- E6206+

BARACUDA G3 IN-GROUND POOL SUCTION CLEANER

*Features "Flowkeeper", Self-Adjusting Water Control Valve
Easy to Install, Pool Owner Friendly*



Baracuda G3

- Baracuda G3 Automatic Pool Cleaner
- Baracuda T-Trap Leaf Catcher #26705
- Baracuda Pacer Inground Suction Cleaner
- Baracuda Beta Above Ground Cleaner
- Baracuda Zippa Above Ground Cleaner *Pressure Side*
- Baracuda Ranger Above Ground Cleaner #01698

- E6000
- E6092
- E6007*
- E6010
- E6012*
- E6045*

*+Limited Stock
Non-Stock Item

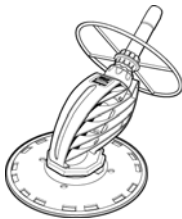

Ranger

KREEPY KRAULY

- Inground Pool Cleaner (Retail Model)
- Inground Pool Cleaner (Vinyl, Fiberglass)
- Inground Pool Cleaner (Gunite/Builder Model)
- EZ Vac Above Ground Cleaner
- Cleaner Hose 5'

- E5300
- E5302
- E5304
- E5306
- E5310

Letro® LEGEND®

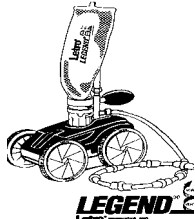

LETRO LEGEND POOL CLEANERS

Legend Pool Cleaner - Less Pump

Color: **White**Color: **Gray**

ITEM NO.

E4187

E4186

Legend Platinum - Less Pump

Color: **Gray/White**Color: **Gray/Gray**

E4100

E4102+

Platinum Truck - Less Pump *Platinum Truck Covers Only**

Color: **Red/White**Color: **Yellow/White**

E4114

E4116+

Platinum Truck Covers Only

Colors: **Red****Yellow****Gray****White**

E4171

E4170

E4172

E4173

Complete Parts
Breakdown on page
303

Legend II Complete

Legend II Complete -Color: **Gray***No Booster Pump Required*

E4195

LL205N Tune Up Kit for 4-Wheel Model

E4191

Legend Wall Fitting w/ Screen - Complete

E4183

Booster Pump Only

Booster Pump Only for Letro Legend Cleaner

E4184

+Limited Stock

HAYWARD POOL CLEANERS

Phantom - Cleans the Pool Bottom, Walls, Steps, and Then Rises to Skim the Surface

Phantom Head & Hose kit Only

E8012

Phantom Booster Pump

E8014



Navigator

Navigator Automatic Pool Cleaner

For In-Ground Gunite Pools*without Leaf Canister*

E5012

Navigator Automatic Pool Cleaner

For In-Ground Vinyl Pools*without Leaf Canister*

E5010



AquaDroid

AquaDroid Head Box

E8002

AquaBug

AquaBug without Leaf Canister

Automatic Pool Cleaner for Above Ground Pools

E8005



Navigator & AquaBug Leader Hose - 4'

E8025

Navigator & AquaBug Connecting Hose - 4'

E8026

Leaf Canisters

Leaf Canister - Standard

W560

E1W560

Leaf Canister - Large Capacity

W530

E1W530

Leaf Basket for W430 & W560

W431A

E1W431A

Permanent Filter Bag for Leaf Canister

AXW538

E1W538

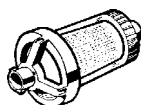

LETRO COMMON PARTS

	MFG. NO.	PENTAIR ITEM NO.	SUB. ITEM NO.
Letro screw self tap #10 x 1/2" SS Pan Head (Bag of 5)	EA30	E3A30	E2A30
Letro spring swing axle (Bag of 2)	EC25	E3C25	E2C25
Letro screw 6-32 x 1/2" SS Pan Head (Bag of 5)	EC32	E3C32	
Letro lock washer RO C36 (Bag of 5)	EC45	E3C45	E2C45
Letro wheel washer (Bag of 2)	EC64	E3C64	E2C64
Letro axle LG wheel	370161	E3C66	E2C66
Letro cover turbine	EC110	E3C97	E2C97
Letro elbow for turbine cover or feed mast tube (2)	LC115	E3C98	E2C98
Letro quick disconnect plug NPTM, plastic	370112	E3D23	E2D23
Letro quick disconnect female plastic	370163	E3D26	E2D26
Letro coupling 1-1/2" NPTFx 3/4" NPTM	370165	E3G09	E2G09
Letro disposable silt bag (4 pack)	LG45	E3G45	E2G45
Letro volute	370168	E3P05	E2P05
Letro drive train gear kit	370169	E2571L	E2571
Letro axle block kit, front & rear	370170	E2542L	E2542
Letro turbine bearing	370171	E2628L	E2628
Letro feed pipe w/out timer	370173	E2605L	E2605
Letro impeller 3/4 HP	370174	E3P15	E2P15
Letro plug 1/8" NPTM	370187	E3P20	E2P20
Letro adjustment screw sweep hose	370198	E3B20	E2B20
Letro nut/bolt SS for volute to bracket (Bag of 2)	LA125	E3P25	E2P25
Pentair bag conversion kit w/bag, for polaris 380/360	370025	E2511L	E2511
Letro Leaf Bag for 280	370184	E3K15	E2K15
Letro Leaf Bag for 360/380	370185	E2519L	E2519
Pentair bag conversion kit w/bag, for polaris 280/180	370024	E3K16	E2K16
Letro belt kit small & large	L91001017	E2527L	E2527
Letro E-clip SS (Bag of 2)	370186	E2515L	E2515
Letro hub-cap	370176	E2520L	E2520
Letro collar bag tie	370177	E2574L	E2574
Letro hose nut (Bag of 2)	LX20	E2534L	E2534
Letro feed hose 1'	370189	E2584L	E2584
Letro sweep hose scrubber	370017	E2514L	E2514
Letro wheel bearing (Bag of 2)	LBB91001108	E2540L	E2540
Letro wheel double side	370178	E2518L	E2518
Letro wheel single side	370176	E2521L	E2521
Letro bolt & nut 10-32 x 7/8" SS pan head (Bag of 2)	LC75	E3C75	E2K75
Letro sweep hose jet with collar	EB25	E3B25	E2B25
Letro tune up kit	L205P	E3A49	E2A49
Letro quick disconnect hose kit	353020	E3P17	E2P17

RAY-VAC®

"The Ultimate Automatic Pool Cleaner"

Complete Parts Break-
down on page 297

Ray-Vac Builder Model for Gunite Pools (Less Energy Kit)

ITEM NO.

F7265

Ray-Vac Builder Model (Black) for Gunite (Less Energy Kit)

F7268

Energy Filter w/ Gauge w/ 1 1/2" CPVC Valve

F7140

Energy Filter w/ Gauge & 2" Never Lube Valve

F7269

Ray-Vac Tune-up Kit

F7118+

Jandy #5870



STA-RITE®



STA-RITE AUTOMATIC POOL CLEANERS

Unique bristle-drive automatically propels unit along pool bottom.

Devours small & large debris - Works well on walls - No tools required

ABOVE GROUND POOLS

Great White Above-Ground Pool Cleaner

GW9000

E5070+

(Removes small & large debris)

IN- GROUND POOLS

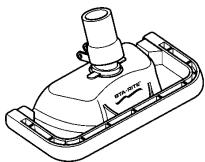

Great White In-Ground Pool Cleaner

GW9500

E5072+

(Includes one 24' & two 8' hoses)

HOSE ACCESSORIES

Floating Unidapt Handle

E5071+

8' Extension Hose - All

E5074

Hose Coupler 6" Long F x F

E5076+

+Limited Stock

RAY-VAC REPLACEMENT PARTS

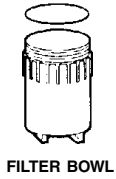

FILTER BOWL

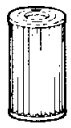

ELEMENT

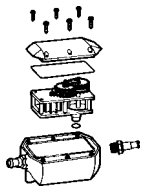

HYDRO TIMER



HOSE EXT. KIT



MENDER SLEEVE KIT

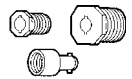

Q. D. COUPLER KIT

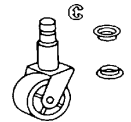

NOSE CASTER WHEEL

	ITEM NO.
Jandy R0373100 Ray-Vac Ladder Guard Kit, Standard	F7526
Jandy R0373400 Ray-Vac Whip Kit	F7532
Jandy R0373500 Energy Filter Bowl	F7534
Jandy R0374000 Energy Filter Top Kit	F7544
Jandy R0374100 Ray-Vac Mender Sleeve 1/2" Kit	F7546
Jandy R0374300 Ray-Vac Hose Kit 5/8" Vinyl w/2 Floats	F7550
Jandy R0374500 Energy Filter O-Ring Kit	F7554
Jandy R0374600 Energy Filter Element Kit	F7556
Jandy R0374700 Ray-Vac Screen, Fine Mesh, White	F7558
Jandy R0375100 Ray-Vac Bottom Complete, White	F7564
Jandy R0375400 Ray-Vac Hose Replacement Kit	F7570
Jandy R0375550 Ray-Vac Bumper Flatmouth Kit - White	F7572
Jandy R0375700 Hose, 1/2" Silicone w/Sleeves & Floats	F7576
Jandy R0375800 Ray-Vac Nose Plate Kit, Gunite, White	F7578
Jandy R0376200 Ray-Vac Nose Plate Kit, Vinyl/Fiberglass	F7586
Jandy R0376400 Sea Anchor Kit	F7590
Jandy R0376500 Ray-Vac Hydro-Timer Replacement Kit	F7592
Jandy R0376900 Ray-Vac Transporter Jet Kit	F7600
Jandy R0377000 Ray-Vac Hydro-Timer Gear Assembly Kit	F7602
Jandy R0377100 Ray-Vac 1/2" Silicone Kit w/Sea Anchor	F7604
Jandy R0377200 1/2" Silicone Hose Kit w/Sea Anchor/Floats	F7606
Jandy R0377300 Ray-Vac Mender Sleeve 5/8" Kit	F7608
Jandy R0377400 Ray-Vac Filter Screen Case	F7610
Jandy R0377500 Ray-Vac Filter Screen	F7612
Jandy R0377600 Ray-Vac Filter Screen Fitting	F7614
Jandy R0377700 Ray-Vac Pressure Gauge	F7616
Jandy R0377900 Ray-Vac Skimmer Guard Kit, Standard	F7620
Jandy R0378000 Quick Disconnect Replacement Kit	F7622
Jandy R0378100 Ray-Vac Swivel Ball Bearing	F7624
Jandy R0378200 Ray-Vac Hose Swivel Rebuild Kit	F7626
Jandy R0378300 Ray-Vac Hose Line Swivel Kit	F7628
Jandy R0378400 Ray-Vac Hose Coupler Kit	F7630
Jandy R0378500 Ray-Vac Hose Pusher Jet Kit	F7632
Jandy R0378600 Ray-Vac Hose Line Whip Y Jet Kit	F7634
Jandy R0378700 Ray-Vac Hose Line Jet Kit	F7636
Jandy R0378800 Ray-Vac Caster Wheel Kit, Gunite, White	F7638
Jandy R0379000 Ray-Vac Nose Wheel Kit, Gunite, White	F7642
Jandy R0378900 Ray-Vac Side Wheel Kit, Vinyl, White	F7644
Jandy R0379200 Ray-Vac Drive Wheel Kit, Gunite, White	F7646
Jandy R0379400 Ray-Vac Caster Wheel Kit, Vinyl, White	F7650
Jandy R0379600 Ray-Vac Swivel Wheel Kit, Vinyl, White	F7654
Jandy R0380200 Ray-Vac Pusher Hose	F7666
Jandy R0380300 Ray-Vac Transporter Jet Sleeve Kit	F7668
Jandy R0380500 Ray-Vac Wear Button Kit, White	F7672
Jandy R0379100 Ray-Vac Swivel Wheel Kit, Gunite, White	F7640

Polaris AUTOMATIC POOL CLEANERS

Complete
Parts
Breakdown
on pages
309-325



380 VAC-SWEEP

Polaris 380 Cleaner

*Latest and most advanced automatic pool cleaner.
Works for all pools. Booster pump required.*

380 Vac-Sweep Head & Hose Box Only
(Use either Booster Pump E2000 or E2004. See pg. 61 for description)

ITEM NO.

E2002

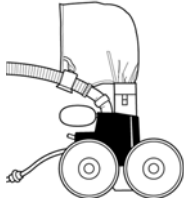

360 VAC-SWEEP

Polaris 360 Cleaner

*Includes head, hose & adjustable flow control kit.
No booster pump required.*

360 Vac-Sweep Complete

E2500

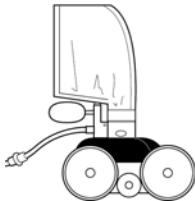

280 VAC-SWEEP

Polaris 280 Cleaner

*Original design with new technical improvements
Booster pump required.*

280 Vac-Sweep Head & Hose Box Only
(Use either Booster Pump E2000 or E2004. See pg. 61 for description)

E2006

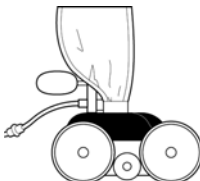

180 VAC-SWEEP

Polaris 180 Cleaner

Original design. Booster pump required.

180 Vac-Sweep Head & Hose Box Only
(Use either Booster Pump E2000 or E2004. See pg. 61 for description)

E2001



165 VAC-SWEEP

Polaris 165 Cleaner

*For all in-ground vinyl pools. Ideal for older pools
w/ lower output filtration pumps. Powered by return line.*

165 Vac-Sweep Complete

E2050



SUPERTURTLE

Polaris Super Turtle

For all vinyl or fiberglass pools. Vacuums & sweeps.

Polaris Super Turtle Cleaner

E2051



65 VAC-SWEEP

Polaris 65 Cleaner

*For above-ground pools. Installs in minutes.
Works by return line pressure.*

65 Above Ground Cleaner

E2060



TURBOTURTLE

Polaris Turbo Turtle

For all above ground pools.

"Turbo Turtle" Above Ground Cleaner

E2061



AUTOMATIC POOL CLEANERS

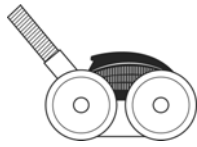

340 VAC-SWEEP



140 SUCTION CLEANER

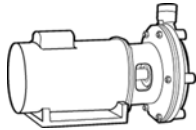

PB4 BOOSTER PUMP

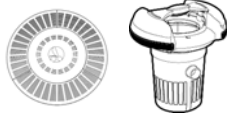

Polaris ATV Suction Powered Cleaner

Connects to skimmer or dedicated suction line
No booster pump required

340 Polaris Cleaner Complete E2040

Polaris 140 Suction Powered Cleaner

Suction Cleaner for all in-ground pools
No booster pump required

140 Polaris Cleaner Complete E2055

ACCESSORIES

Polaris Booster Pump PB4

3/4 HP Pump drives Polaris 180, 280 & 380 Cleaner

E2000

Polaris Halcyon Booster Pump w/ Quiet Motor

3/4 HP Pump drives Polaris 180, 280 & 380 Cleaner

E2004

Polaris UniCover - White

Main drain cover for suction side cleaners

#5820

E2070

Polaris UniCover - Gray

Main drain cover for suction side cleaners

#5825

E2069

Polaris LCS Leaf Canister & Skimmer

Collects debris from pool surface & captures it from cleaner

#5810

E2072

Polaris Revolve-it

Prevents cleaner hose from kinking

#5800

E2074

Complete
Parts
Breakdown
on pages
326-327

MOST COMMONLY USED POLARIS PARTS

PART NO.	DESCRIPTION
G-52	Backup Valve Kit (Replaces G-41)
A-16	Bag, All-Purpose for 180
K-16	Bag, All-Purpose for 280
9-100-1014	Bag, All-Purpose for 360/380
9-100-1015	Bag, Sand/Silt for 360/380
C-60	Ball Bearings, Wheel
9-100-1108	Ball Bearings, Wheel
9-100-1017	Belt Kit - Small & Large
A-47	Factory Rebuild Kit
A-49	Factory Tune-Up Kit
9-100-9010	Factory Tune-Up Kit
D-15	Feed Hose Nut
D-20	Feed Hose Swivel w/ Ball Bearing
D-10	Float for Feed Hose
A-20	Float for Head
D-31	Hose Barb/Strainer Housing
B-05	Sweep Hose Complete
9-100-3105	Sweep Tail Scrubber
C-10	Tire - Large, White
6-500-00	UWF Universal Wall Fitting (all pressure side)
9-100-9001	UWF Connector Assy for 180/280/380
G-9	Wall Fitting 3/4" MPT X 1-1/2" FPT
C-6	Wheel, Large
C-16	Wheel, Small
9-100-1008	Wheel - Double Sided
9-100-1116	Wheel - Single Sided
9-100-1021	Bag, All-Purpose for 380 Zipped
K-13	Bag, All-Purpose for 280 Zipped

180	280	360	380	
*	*		*	E2G52
*				E2A16
	*			E2K16
		*	*	E2511
		*	*	E2513
*	*			E2C60
		*	*	E2540
		*	*	E2527
*				E2A47
*	*			E2A49
		*	*	E2601
*	*		*	E2D15
*	*		*	E2D20
*	*		*	E2D10
*	*	*	*	E2A20
*				E2D31
*	*		*	E2B05
*	*	*	*	E2514
*	*	*	*	E2C10
*		*	*	E2524
*	*		*	E2522
*	*		*	E2G09
*	*			E2C06
*	*			E2C16
		*	*	E2518
		*	*	E2521
			*	E2512
	*			E2K13



For Dark Bottom Pools



Polaris 380 "Black Max" Cleaner

For in-ground pools. Works with booster pump

380 Black Max Head & Hose Box Only

E2003

(Use either Booster Pump E2000 or E2004)



Polaris 360 "Black Max" Cleaner

No booster pump required

360 Black Vac-Sweep Complete

E2030



Polaris ATV "Black Max" Cleaner

Suction side cleaner. No booster pump required

340 Black Max Suction Side Cleaner

E2042+

Polaris 280 "Black Max" Cleaner

For in-ground pools. Works with a booster pump

280 Black Max Cleaner Head & Hose Box Only

E2007

(Use either Booster Pump E2000 or E2004)



280 Factory Rebuild Kit

E2K48

280/180 Factory Rebuild Kit

E2K49

COMMON BLACK POLARIS PARTS

(See Appendix 293 For Interchangeable Parts)

PART NO.	DESCRIPTION	280	340	360	380	
G-62	Backup Valve Kit, Black	*			*	E2G62
G-67	Backup Valve Collar, Black	*		*	*	E2G67
9-100-1016	Bag, All-Purpose, Black			*	*	E2450
K-17	Bag, All-Purpose, Black	*				E2K17
9-100-7017	Base Assy. for In-Line Back-up Valve, Black			*	*	E2613
9-100-3010	Connector Assembly, Black			*		E2D08
G-6	Feed Hose - Complete w/UWF, Black	*			*	E2G06
D-47	Feed Hose, 10 Ft., Hard, Black	*			*	E2D47
K-31	Feed Pipe with Elbow, Black	*				E2K31
D-11	Float for Feed Hose, Black	*			*	E2D11
A-21	Float for Head, Black	*		*	*	E2A21
9-100-1115	Hub Cap, Black		*	*	*	E2456
D-16	Nut, Feed Hose, Black	*			*	E2D16
D-30	Quick Disconnect, UWF, Black	*			*	E2D30
B-06	Sweep Hose Complete, Black	*			*	E2B06
B-16	Sweep Hose Attach Clamp, Black	*		*	*	E2B16
D-21	Swivel w/Ball Bearing for Feed Hose, Black	*			*	E2D21
9-100-3003	Swivel Hose for 360, Black			*		E2D09
C-11	Tire - MaxTrax, Black	*		*	*	E2C11
K-6	Top, Black	*				E2K06+
9-100-1142	Top Cover, Single Wheel Side, Black			*	*	E2626+
9-100-1143	Top Cover, Double Wheel Side, Black			*	*	E2627+
6-550-00	Universal Wall Fitting, Black	*		*	*	E2507
G-9	Universal Wall Fitting, Black	*		*	*	E2G09
9-100-9005	Universal Wall Fitting Connector Assy, Black	*			*	E2462
K-21	Vacuum Tube, Black	*				E2K21
9-100-1004	Wheel - Double Sided, Black			*	*	E2454
9-100-1117	Wheel - Single Sided, Black			*	*	E2458

+Limited Stock



ELECTRIC VACUUM PUMP

1 HP Pump & 2-wheeled cart .
Each unit comes equipped with GFCI protected 50' electrical cord. Features 1-1/2" suction & discharge wet end & comes with barbed hose fittings.

(Need 3 Day Notice)

K3179

Portable 1HP Pump.

Electric Powered with stainless steel cart

K3179S



PORTABLE FILTER SYSTEM

"The Scamp" portable filter system comes mounted on a stainless steel cart equipped with 1 HP self-priming pump & 75 sq. ft. see-thru cartridge filter. Unit is rated at 50 psi & fitted with 15 amp GFCI for safety.

*Non-Stock Item

K3185*

Harmsco BKP Portable Filters Available in Eight Models. Ask for Information and Prices

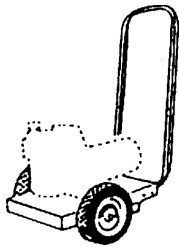

Pump Cart

	ITEM NO.
Portable Pump Cart #710	K1080
Portable Pump Cart #7105 (Stainless Steel)	K1081
Tiered Pump Cart #716 (S.S.- Used In Scamp System)	K1082

POWER VAC - 12 Volt Marine Battery Operated



A portable self-contained vacuum designed to clean fountains or average 15' x 30' pool in less than 10 minutes. Weighing only 16 lbs. can be carried by hand or on service cart (sold separately). 12 Volt battery & charger not included.



Power Vac PV2100 Cleaner w/ 45' Cord <i>6" Throat w/ filter bag & battery carrying case</i>	K3190
Power Vac PV2200 Cleaner w/ 45' Cord <i>8" Throat w/ interchangeable props for different suction</i>	K3191*
Power Vac PV2500 Fountain Vac <i>For tough to clean fountains or shallow pools</i>	K3193*
Power Vac Service Cart - Truck Mount <i>Includes H.D. switch, battery box & charge plug</i>	K3192*
Power Vac Heavy Duty <i>Small Bag #022</i>	K3194
Power Vac Super Fine <i>Mesh Bag #019</i>	K3195

*NOT ALL ITEMS IN STOCK!

1-1/2" DELUXE VAC HOSE - with Swivel Cuff*Residential Grade - Not for use in service or commercial application***Good**

		ITEM NO.
1-1/2" x 25'	Deluxe Vac Hose	F1014
1-1/2" x 30'	Deluxe Vac Hose	F1021
1-1/2" x 35'	Deluxe Vac Hose	F1027
1-1/2" x 40'	Deluxe Vac Hose	F1032
1-1/2" x 45'	Deluxe Vac Hose	F1036
1-1/2" x 50'	Deluxe Vac Hose	F1041

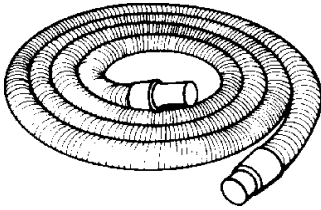
1-1/2" PREMIUM VAC HOSE - with Swivel Cuff*Maximum UV & abrasion resistance***Better**

1-1/2" x 25'	Premium Vac Hose	F1150
1-1/2" x 30'	Premium Vac Hose	F1151
1-1/2" x 35'	Premium Vac Hose	F1152
1-1/2" x 40'	Premium Vac Hose	F1153
1-1/2" x 45'	Premium Vac Hose	F1154
1-1/2" x 50'	Premium Vac Hose	F1155

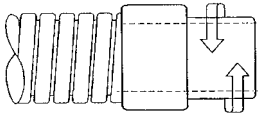
HEAVY DUTY VAC HOSE - with Swivel Cuff*Ultimate hose for the pool service professional***Best**

1-1/2" x 25'	Heavy Duty Vac Hose	F1015
1-1/2" x 30'	Heavy Duty Vac Hose	F1020
1-1/2" x 35'	Heavy Duty Vac Hose	F1025
1-1/2" x 40'	Heavy Duty Vac Hose	F1030
1-1/2" x 45'	Heavy Duty Vac Hose	F1035
1-1/2" x 50'	Heavy Duty Vac Hose	F1040
1-1/2" x 75'	Heavy Duty Vac Hose	F1094
2" x 50'	Heavy Duty Vac Hose	F1159

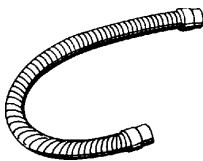
1-1/4" VAC HOSE & FILTER CONNECTORS*Classic (Blow Molded) & Deluxe Grade*

1-1/4" x 3'	Classic Vac Hose H.D. (Silver)	F1003
1-1/4" x 6'	Classic Vac Hose H.D. (Silver)	F1004
1-1/4" x 252'	Classic Vac Hose	F1010
	<i>Cuffed Every 3'</i>	
1-1/4" x 3'	Deluxe Vac Hose (Black)	F1016
1-1/4" x 6'	Deluxe Vac Hose (Black)	F1017
1-1/4" x 21'	Deluxe Vac Hose	F1002
1-1/4" x 24'	Deluxe Vac Hose	F1001
1-1/4" x 30'	Deluxe Vac Hose	F1005
1-1/4" x 36'	Deluxe Vac Hose	F1006

1-1/2" SWIMMING POOL FILTER CONNECTORS*Classic (Blow Molded) & Deluxe Grade*

1-1/2" x 3'	Classic Vac Hose H.D. (Silver)	F1048
1-1/2" x 6'	Classic Vac Hose H.D. (Silver)	F1050
1-1/2" x 150'	Classic Vac Hose	F1046
	<i>Cuffed Every 3'</i>	
1-1/2" x 3'	Deluxe Vac Hose (Black)	F1018
1-1/2" x 6'	Deluxe Vac Hose (Black)	F1019
1-1/2" x 12'	Deluxe Filter Connector Hose	F1009

VAC HOSE REEL



Lightweight & portable polyethylene hose storage reel.

Helps keep hose cleaner & free from tangles

Holds up to 50' of 1-1/2" Vacuum Hose

Vacuum Hose Reel - Portable

ITEM NO.
W5420

VAC HOSE REEL - *Stainless Steel*

High quality hose reel ideal for storing unsightly & cumbersome pool vacuum hose. Its unique solid stainless steel construction ensures

many years of trouble free use with minimal maintenance. Each reel holds up to 100' of 2" diameter hose. Units are portable

& designed to fit through a standard door.

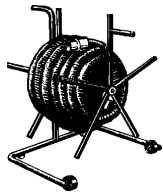

F1196



F1125

Stainless Steel Hose Reel	F1196*
Hose Hugger For Pool & Vacuum Hose 3" x 27" w/Display	F1125
Hose Hugger for Pool & Vacuum Hose 3" x 27" wo/Display	F1126
Hose Hugger for Pool & Vacuum Hose 3" x 34" wo/Display	F1127

*Non-Stock Item

CLEAR VINYL HOSE



1-1/4" ID x 50' Clear Vinyl Hose	F2120
Cut to Size - Per Foot	F2122
1-5/8" ID x 50' Clear Vinyl Hose	F2124
Cut to Size - Per Foot	F2126
2-1/2" Vinyl Hose - Per Foot	F2128
Fits over 2-1/2" pipe and 2" fittings	

RADIATOR HOSE

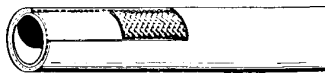

1-5/8" ID x 3' Radiator Hose	F1320
1-7/8" ID x 3' Radiator Hose	F1322
2-1/4" ID x 3' Radiator Hose	F1324

Vac Hose Accessories

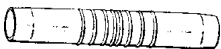

F1100



F1110

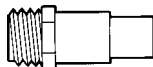

F1105



F1114



F1116



F1118

1-1/4" Hose Joiner	F1100
1-1/2" MPT x 1-1/2"/1-1/4" Smooth Hose Adapter	F1105
1-1/2" MPT x 1-1/2" Smooth Hose Adapter	F1106
1-1/2" MPT x 1-1/4" Smooth Hose Adapter	F1103
1-1/2" MPT Check Valve Combo Adapter SP1091CV	F1107
1-1/2" Elbow MPT x 1-1/4" Smooth Hose Adapter	F1108
1-1/2" Elbow MPT x 1-1/2" Smooth Hose Adapter	F1110
1-1/2" Barbed Hose Elbow SPX1105Z4	H6430
1-1/4" Repair Cuff for Vac Hose	F1115
1-1/2" Repair Cuff for Vac Hose	F1116
2" Repair Cuff for Vac Hose	F1121
1-1/2" Swivel Repair Cuff	F1123
2" Repair Cuff for Vac Hose	F1124
1-1/4" Repair Coupling for Vac Hose	F1122
1-1/2" Repair Coupling for Vac Hose	F1114
2" Repair Coupling for Vac Hose	F1120
Hose Hanger - (Pair with Screws)	F1118
Pole Hanger--(Pair)	F1119
Pole & Hose Hanger - Pair (Aluminum)	F6086
Aluminum Hanger for Hose or Pole (Pair)	Y3058
Hayward SPX1082Z3 Vac Hose Adapter 2" MPT x 1-1/2" SMO	L1933



ASTRAL

ASTRAL COMMERCIAL

Astral 14" H.D. Commercial Vac Head

Strong Aluminum Body with Plastic Ends

ITEM NO.
F4071

Astral 18" H.D. Commercial Vac Head

Strong Aluminum Construction. Fits 1-1/2" Hose

F4073

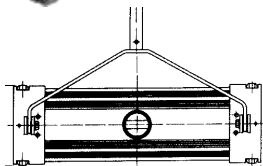

Astral 18" H.D. Commercial Vac Head

*Housing made of chromed bronze & polished anodized aluminum
Fits both 1-1/2" & 2" VacHose*

F4074

Astral 31" Commercial Tow Vac - Alum & Bronze

Trailed with cable (not included) - Accepts 2" Hose

F4076

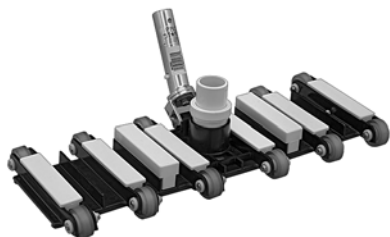

Blue Devil Pro Series 19" Flex Vac -

With 1-1/2" & 2" port and swivel metal handle

F4033

RAINBOW COMMERCIAL

ABS & polyethylene with lead weights fully enclosed. Adjustable polyurethane wheels swivel in any direction. Includes 1-1/2" flex hose swivel connection to prevent twisting.

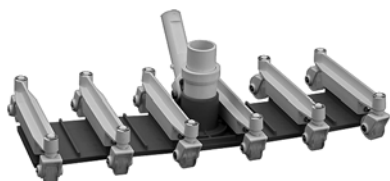

19" Commercial Flex-Vac 250 with Swivel Wheels

F3045

19" Plastic Head with Clip & 12 Wheels

Fits both 1-1/2" & 2" Hose

4/Case

RAINBOW PRO VAC SERIES

*Created by & for professional servicemen, the Pro Vac cleans a pool bottom faster - even with low flow suction. Features unique suction chamber which concentrates vacuum velocity equally from both ends as well as front to back. Strategically weighted with adjustable wheels. All components are replaceable.
1-1/2" & 2" vac hose connection*



14" Pro Vac Residential Flex-Vac Head

#214R

F3046

*with 8 Solid Molded Wheels
& Plastic Snap-Adapt Handle*



22" Pro Vac Commercial Flex-Vac Head

#222

F3047

*with 12 Ball Bearing Wheels
& Metal Swivel Adapt Handle*

29" Pro Vac Commercial Flex-Vac Head

#229

F3048

*with 16 Ball Bearing Wheels
& Metal Swivel Adapt Handle*

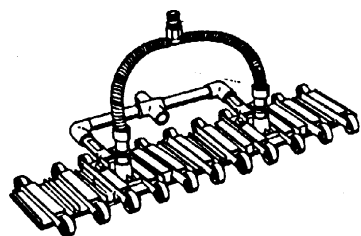

41" Super Pro Vac

#241

F3049

*For increased speed in cleaning large
commercial pools - 22 Ball Bearing Wheels*

FLEX VAC HEADS

For CONCRETE POOLS



F3009

Aquality/Sta-Rite 14" Flexmaster 3028

Flexible 5 lb. Vac w/Pool Saver Side Bumpers. Adjustable Wheel Slots.

PACKING
6/Case

ITEM NO.
F3009



F3005

Astral 14" Flexible Vac Head - 1-1/2"

Made of Injected Molded Polyethylene w/Rubber Tires for Better Traction.

4/Case

F4072

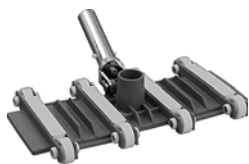

F3006

Vac Head 14" 203LW

F3005

Flex Vac Head 201 with Solid Wheels

Replaces American Flex-A-Vac. Economy Design w/Adjustable Wheels.

6/Case

F3006



F3002

Flex Vac Head 188 with Solid Wheels

12" Plastic Head w/Clip & 8 Wheels. Lead Weights in Polyethylene Housing

6/Case

F3002



F3010

Flex-Vac Head 188 with Ball Bearing Wheels

12" Plastic Head w/Metal Swivel Handle & Ball Bearing Wheels

6/Case

F3008

Economy Flex II Vac Head 14"

14" Plastic Head w/ABS Handle, All Plastic Axles & Handle Pin.

12/Case

F3010



F4039

Poolmaster Basic 14" Flex Vac

6/Case

F4039

VAC HEADS

For VINYL LINER POOLS



F4055

Pentair Vac Head R201392
Opaque Triangular Body
& VinylGard Bumper. Wt. 3 Lbs.

PACKING
6/Case

ITEM NO.
F4055



F4070

Astral Clear View Vac Head
Strong Polycarbonate See-Through
Housing & Polypropylene Brushes.

12/Case

F4070



F4015

Vac Head (HP-500 - type)
13" Head with Stabilizer Spring
Fits 1-1/4" & 1-1/2" Hose Wt. 3 Lbs.

12/Case

F4015



F4000

Basic Vinyl Vac Head

F4038

Economy Vac Head 191
ABS w/Polypropylene Brushes.
Fits 1-1/4" & 1-1/2" Hose

24/Case

F4000



F4028

Hayward Power Vac SP-1067

5/Case

F4028



Hayward Super Vac SP-1068DL
Triangular Super Vac Deluxe

10/Case

F4029



F4045

Hayward Super Vac SP-1068
Triangular Vac Head w/3 Brushes.
Swivel Hose Connections Included.

10/Case

F4030

Replacement Handle sp1067-QA K6207
Replacement Brush Kit spx1068G3 F4031
Weight Pak (3 Weights) sp1068FA F4032

Poolmaster Triangular Vac Head (Clam Pak) 6/Case **F4045**
Full View ABS Model w/Channel Brushes.
Fits 1-1/4" & 1-1/2" Hoses. Wt. 4 Lbs.

Triangular Vac Head **12/Case** **F4046**
See thru - Weighted loose pack



F4035

Triangular Vac Head **12/Case** **F4035**
12" Head Fits 1-1/4" & 1-1/2" Hose

Replacement Brush Kit 195R **F4036**

Pentair Oval Vac Head #193 **12/Case** **F4025**
ABS Model w/Protective Vinyl Bumper
Fits 1-1/4" & 1-1/2" Hose. Wt. 3 Lbs.

Replacement Brush Kit 193R **F4026**



F3210

Rainbow "Basic" Oval Vac Head **12/Case** **F3210+**
Weighted w/Poly Bristles

+Limited Stock

ALL PURPOSE VAC HEADS

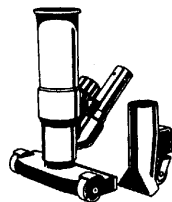

F3032

Poolmaster Black Magic Jet Vac Head With Bag

7" Head with Brushes
Used with Garden Hose

PACKING
6/Case

ITEM NO.
F3032



F3205

Poolmaster Mini Magic Jet Vac Head

for Pool, Spa or Pond

12/Case

F3030

Rainbow "Basic" Uni-Vac Jet Vac

Repl. Bag for Poolmaster Black Magic Vac (*All Purpose*)

Repl. Bag for Poolmaster Jet Vac (*Fits VJ12*)

Repl. Bag for Rainbow 208 Mini Vac (*Silt Sock*)

4/Case

F3205+

F3033

F3031

F3034

REPLACEMENT PARTS FOR VAC HEADS

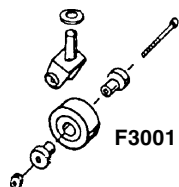

F3001



F3014



F3019



F3017

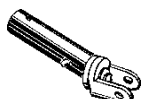

F3015



F3003



F3022

		ITEM NO.
Rainbow Caster Support	R03032	F3024
Rainbow Axle Assembly (No Wheel)	R201606	F3106
Rainbow Hose Swivel Adapter	R201566	F3020
4 Wheels with Axle Assembly	R201450	F3016
4 Wheel Replacement Kit	R201500	F3029
4 Ball Bearing Wheel Assembly	R201558	F3014
Blue Devil 9701C Vac Wheel Assembly (Set of 4)	B9701C	F7088
Steerable Attachment Only	R201406	F3017+
Handle Replacement - w/Clip	R201476	F3019
Handle Replacement - Metal w/Swivel	R201408	F3015
Bolt & Nut, S.S. for Handle	R201496	F3003
Handle Connecting Pin - Plastic 2-1/4"	R03101	F3022
Handle Connecting Pin - Plastic 1-3/4"	R03086	F3023
S.R. Smith Wheel w/ Axle Kit (4 Each)		F3036+
Pole-Spring Clip-Set/3	#170	F6100

+ Limited Stock

LEAF TRAPS

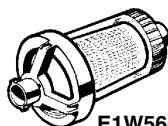

E1W560

Hayward Standard Capacity Leaf Trap

#W560 E1W560

Hayward Large Capacity Leaf Trap

#W530 E1W530

Leaf Trap with Snap Open Lid & Mesh Bag 1-1/2"

Clear Housing - Let's you see the debris

#186A F7056

Leaf Trap with Snap Open Lid and Mesh Bag 2"











#186B F7064



F7056

Pentair Standard Mesh Bag (180 Leaf Trap)	F3124
Rainbow Sand/Silt Bag	R211518 F3128
Screen Bag (179 Leaf Trap)	F7058
Vinyl Coated Basket (179 & 186 Leaf Trap)	F7059
Clear Lid (179 Leaf Trap)	F7057
O-Ring for Lid (179 & 186 Leaf Trap)	H5466
3' Vac Hose (179 & 180 HD Leaf Trap)	F7067
O-Ring for Lid (180 HD Leaf Trap)	F7066
Replacement Lid (180 HD Leaf Trap)	F7068
Vinyl Coated Basket (Blue) (180 HD Leaf Trap)	F7069

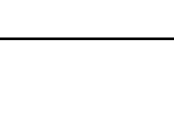
HAND SKIMMERS

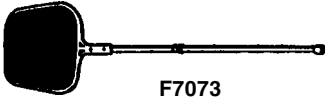
		PACKING	ITEM NO.
	Blue Devil Hand Skimmer w/ Clip #LS-3N1 <i>With rock scoop</i>	12/Case	F7015
F7015			
	Nycon Commercial H.D. Skimmer 14" x 15" <i>With dacron mesh & clip</i>	24/Case	F7047
F7047			
	Poolmaster Poly Leaf Skimmer #18200 <i>Molded one piece frame</i>	12/Case	F7006
F7006			
	Poolmaster Pro Leaf Skimmer #18200 <i>Extra heavy duty aluminum frame</i>	12/Case	F7020
F7019			
	Poolmaster Deluxe Leaf Skimmer #120010 <i>Aluminum frame w/ plastic rim</i>	12/Case	F7019
F7019			
	Rainbow Hand Skimmer w/Clip #124S <i>Polypropylene construction w/ polyester screen</i>	12/Case	F7005+
F7005			
	Rainbow Hand Deep Net Skimmer #118	12/Case	F7037
F7002			
	Rainbow Hand Skimmer ABS #119 <i>With reinforced aluminum</i>	12/Case	F7002
F7002			
	Hand Skimmer - Aluminum #126 <i>Molded screen snaps into aluminum frame</i>	12/Case	F7025
F7025			
	Hand Skimmer - Replacement Screen <i>Replaces Obsolete Numbers: #126RFM & #121222</i>		F7030
F7010			
	Skimlite Leaf Skimmer - w/8" Pocket #R8C <i>Plastic Frame - bolts into pole - does not include bolts</i>	12/Case	F7010
F7010			
	*Hand Skimmer w/ 4' Pole #404H	12/Case	F3223
F7073			
	*Hand Skimmer w/ 5' Pole	24/Case	F7040
	*Hand Skimmer w/ 4 to 8' TelePole	12/Case	F7073

*Truck Orders Must be Full Cases

+Limited Stock

LEAF RAKES



			ITEM NO.
Basic Leaf Rake	#18215	2/Case	F7054
20" Leaf Rake	#122	12/Case	F7055
20" Econo Leaf Rake	#123	12/Case	F7048
Pro Leaf Rake	#117	12/Case	F7049
Repl. Frame & Net	#117R	12/Case	F7049
Premier Leaf Rake	#21196	12/Case	F7060
20" Std. Leaf Rake Plastic #125005B		12/Case	F7061
H. D. Leaf Rake	30" x 8"	12/Case	F7062
<i>with Dacron Mesh & Clip</i>			
Economy H.D. Leaf Rake	19" x 6"	24/Case	F7051+
Skim-Lite DuraPro Maxi Leaf Rake			
16" Pocket	20" x 10"	12/Case	F7052+
Red Baron Leaf Chaser	20" x 20"	Each	F7044
Red Baron Rag Bag	20" x 20"	Each	F7046

+Limited Stock

LEAF BAGGERS

Works with garden hose or automatic cleaner to remove debris by venturi action

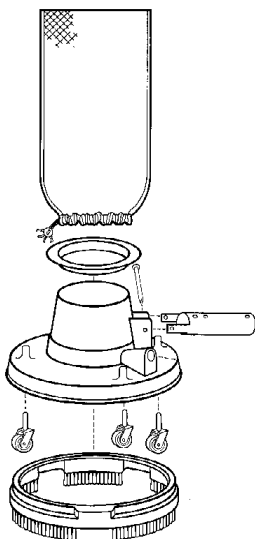

Jandy Leaf Bagger w/Wheels for Concrete Pools		F7072
Jandy Leaf Bagger w/Brushes for Liner Pools		F7071
Standard Leaf Bagger w/Wheels for Concrete Pools		F7070
#S-101 Standard Bag	15" x 21"	F7076
#S-777 Fine Mesh Bag	15" x 26"	F7077
#S-999 Extra Large Bag		F7079
Leaf Bagger Quick Connector		F7080
Swivel Wheel Bracket, Wheel & Pin (3)		F7086
Top Ring for Leaf Bagger		F7084
Jandy Hose Fitting with Clip #2167		F7089
Jandy Handle Assy with Clip #1150		F7081
Jandy Wheel Assy	#1218	F7087
Jandy Repl. Brush Ring	#1223	F7074+
Jandy Handle Lock Pin	#1226	F7091
Jandy Bag Ring for Leaf Master#1219		F7092

+Limited Stock

MAINTENANCE KITS



Hatchik Maintenance Kit for Gunite Pools	F1925S
PM Basic Maintenance Kit for Gunite Pools <i>(Brush, Hand Skim, Flex Vac, Thermometer, Test Strips)</i>	F3234
Ocean Blue Maintenance Kit for Gunite Pools	F3235

ALUMINUM BOLTED POLES

A lightweight durable non-telescopic aluminum pole. 1-1/4" O.D.

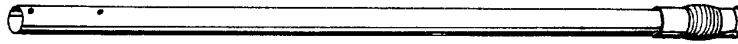

		PACKING	ITEM NO.
12'	Straight Bolted Pole	12/Case	F6000
16'	Straight Bolted Pole	12/Case	F6005

ALUMINUM TELESCOPIC POLES

Constructed of high quality drawn anodized aluminum tubing. Telescopic poles are fully adjustable with a simple twist of locking device. Pre-drilled for snap-adapt or bolt-on piece of equipment.



4' to 8'	Telescopic Pole - External Locking Cam	12/Case	F6008
6' to 11'	Telescopic Pole - External Locking Cam	12/Case	F6010
8' to 15'	Telescopic Pole - External Locking Cam	12/Case	F6015
8' to 16'	Telescopic Pole - Posi-Lock POutside Cam	12/Case	F6014
4' to 8'	Telescopic Pole - Eliptilok	12/Case	F6009
6' to 11'	Telescopic Pole - Eliptilok	12/Case	F6011
8' to 15'	Telescopic Pole - Eliptilok	12/Case	F6013
12' to 24'	Telescopic Pole - Twist Lock	12/Case	F6034
16' to 32'	Telescopic Pole - Ext. Nylon Locking Cam	12/Case	F6027
8' to 16'	Telescopic Fiberglass Pole - Orq Xcaliber		F6200
6' to 16'	UPS-able 3 PC Telescopic Outside Cam		F6028
6' to 18'	UPS-able Extra Heavy Duty 3 PC Telescopic Outside Cam		F6029

FIBERGLASS POLES

Constructed of rigid fiberglass with E-Z lock compression type locking device. Poles are manufactured to withstand abuse such as required by professional pool serviceman & areas where protection from electrical shock is mandatory. Poles are UV protected with coating to prevent splintering with age.



12'	Commercial - 818-12 Straight Fiberglass	F6036
8' to 16'	Telescopic Fiberglass Pole - E-Z Lock Fitting	F6042
8' to 16'	Telescopic Fiberglass Pole - Orq Xcaliber	F6202
12' to 24'	Telescopic Fiberglass Pole	F6035



STAIN MASTER

Allows underwater application of muriatic acid only where it's needed. Easily removes rust, scale & other stains without removing water from the pool

Jandy Stain Master	#1148	F7100
--------------------	-------	-------

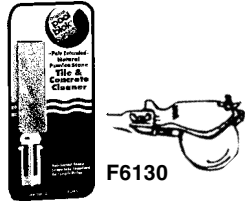

F6130

A6101

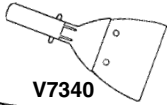

V7340



F6120

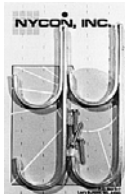

F5719



F6085

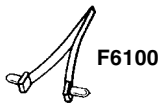

F6100



F6055

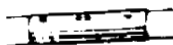

F6063



F6109



F6067



F6090

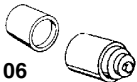

F6106

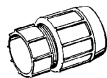

F6108

POLE ACCESSORIES & PARTS

Algae-Gon Remover

Holds 3" chlorine tablet for black algae spots

ITEM NO.
F6130

Black Algae Scraper

Removes black algae from plaster walls. Snaps onto pole

V7340

Pumice Stone for Telescopic Pole



Rust Stone

Stone abrasive for stains. Fits on pole end.

#146S

F6120

Magnet Sander

F6115+

Pole Hangers - Set of Two (Plastic) Rainbow

F6085

Pole Hangers - Set of Two (Aluminum) Rainbow

F6086

Pole Hangers - Set of Two (Aluminum)

F1119

Combo Pole & Hose Hanger (Plastic)

F6087

Wing Nut & Bolt for Pole (Bag of 6)

F6070

Spring Clips for Poles (Set of 3)

#170B

F6100

Pole Adapter

Snap adaptor & bolted end connector allows quick change (Set of 3)

#147S

F6055

Adapter to Course Thread for Tele Pole

F5097+

Pole adapter Sleeve

Attaches two 8 Ft. fiberglass sections together. Includes nuts & bolts.

F6063

Conversion Adapter - Female Threads for 1-1/4" Pole

F6064

Replacement Tip for Fiberglass Pole

F6067

Female Brass Threaded Fitting for 1-1/4" Alum Pole

F6061

Male Brass Threaded Fitting for 1-1/4" Alum Pole

F6060

Male Brass Threaded Fitting for 1-1/2" Alum Pole

F6065

Female Brass Threaded Fitting for 1-1/2" Alum Pole

F6066

Replacement Pole Caps, 1-1/8" #1125

F6095

Replacement Pole Caps, 1-1/4" #900

F6090

Vinyl Hand Grip - White

F6109

Metal Cam Set - Smooth Metal Poles

#803

F6106

E-Z Lock Plastic Cam Set - for Metal Poles

#806

F6108

E-Z Lock Plastic Cam Set - Fiberglass Poles

#807

F6107

Plastic Cam Set - for Smooth Poles

F6111+

+Limited Stock

POOL WALL BRUSHES

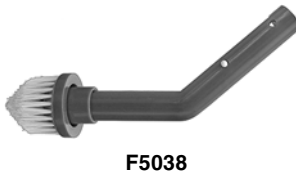

		ITEM NO.
Spa Brush - Soft Bristles	12/Case	F5078
17 1/2" Basic Pool Brush	12/Case	F5006
<i>With Aluminum Bracket</i>		
18" All Plastic Wall Brush with Clip	12/Case	F5005
<i>Economy all plastic brush designed for long life</i>		
18" All Plastic Wall Brush with Clip WB350	12/Case	F5008
<i>One piece molded white body with 5 rows poly bristles</i>		
18" Wall Brush with Alum. Bracket & Clip	12/Case	F5015
<i>Deluxe strong brush with multiple rows of poly bristles</i>		
Replacement Brush for Alum. Bracket Brush		F5016+
18" Combo Wall Brush with Alum. Back	12/Case	F5017
<i>Blended S.S. & blue nylon bristles (Not for vinyl liners)</i>		
18" Goldline Wall Brush	#7016 12/Case	F5002+
<i>Blended nylon bristles</i>		
18" Pro Combination Wall Brush	#119 12/Case	F5096
<i>Contains both stainless steel & synthetic bristles</i>		
24" Giant Wall Brush - Straight Back	12/Case	F5020
<i>Stiff & aggressive w/black nylon bristles</i>		
24" Commercial Wall Brush - Curved Ends	12/Case	F5021
<i>Alum. bracket w/blue nylon bristles & white back</i>		
27" Giant Wall Brush - Curved Ends	12/Case	F5024
<i>Filled with 5 rows of white nylon bristles</i>		
36" Olympic Size Wall Brush	6/Case	F5025
<i>Filled with 5 rows 1-1/2" trim white nylon bristles</i>		
Corner Brush with Synthetic Bristle	12/Case	F5038
Wall Whale 18"		
<i>w/ PVC Bristles</i>	12/Case	F5061
<i>w/ PVC & Wire Bristles</i>	12/Case	F5062

SCRUBBERS

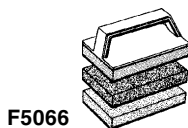
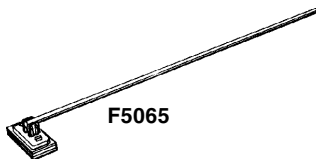

Tile Scrubber with 48" Handle	12/Case	F5065+
<i>Light Duty 3-1/2" x 6" Scrub Pad on one side</i>		
<i>- Medium duty on other with sponge center</i>		
Tile Swivel Scrub Brush - Threaded		F5052
Universal Swivel Handle w/ Removable Pad	12/Case	F5053+
Nylon Scouring Pads 6" x 9"	60/Case	F5055+
Multipurpose Brush #650	12/Case	F5066
<i>Surface scrubber with 3 interchangeable pads</i>		
Replacement Scrubber Pads (Set of 3)		F5067+
Mini Scrub Brush #652		X1162
<i>Iron shaped multipurpose brush with poly bristles</i>		

+Limited Stock



ACID BRUSHES

Unaffected by acid or harsh chemicals

	PACKING	ITEM NO.
10" Wood Acid Brush with Plastic Bristles <i>Use with Tapered Pole</i>	12/Case	F5070
Dual Surface Acid Brush - Threaded	12/Case	F5075



WOOD POLE HANDLES

60" Wood Handle with Tapered End - Thick	24/Case	F5080
60" Wood Handle with Threaded End	12/Case	R1055
60" Wood Handle with Plastic Threaded Tip	24/Case	F5081
60" Wood Handle with Metal Tip	12/Case	R1060



S.S. ALGAE BRUSHES

Small Algae Brush w/S.S. Bristles (Al. Backed)	12/Case	F5031
Small Algae Brush w/ Stainless Steel Bristles	12/Case	F5030
10" Algae Brush with Stainless Steel Bristles	12/Case	F5032
10" Algae Brush with S.S. Bristles (Al. Backed)	12/Case	F5033
18" Algae Brush with Stainless Steel Bristles	12/Case	F5035
Corner Brush w/ Stainless Steel Bristles and Clip	12/Case	F5037



FLOOR BRUSHES

16" Street Broom (Use with Tapered Handle)	F5095
18" Heavy Duty Floor Brush - Threaded	F5085
24" Heavy Duty Floor Brush - Threaded	F5090
58" Corn Broom	F5046



FLOOR SQUEEGIES

18" Floor Squeegee #6118	F5041
24" Floor Squeegee #6124 <i>Use with 60" Tapered Wood Pole (F5080)</i>	F5043
24" Curved Squeegee	F5044
36" Curved Squeegee	F5045



ADJUST-A-BRUSH

or use on pool, spa, boat, home or automobile. Handle made of premium drawn aluminum tubing with non-slip hand grips. Telescopic handle optional for those hard to reach areas.



48" Handle, Knuckle & Medium Pad	F6800+
36" to 72" Telescopic Handle, Knuckle & Medium Pad	F6805+
Replacement Scrub Pad - Coarse	F6815+
	<i>+Limited Stock</i>

Little Giant

"Your Solution Innovator"



WATER WIZARD MAINTENANCE PUMPS

Dependable & Long Running. Pumps down to 1/8". Aluminum housing, 1/6 HP, 1" discharge. Includes garden hose adaptor & removable inlet screen for easy cleaning.

ITEM NO.

- 5-MSP Manual Water Wizard Maintenance Pump** K1004
1200 GPH @ 1' with 25' Cord
- 5-ASP Automatic Water Wizard Maintenance Pump** K1009
1200 GPH @ 1' with 18' Cord

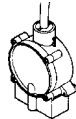

- Low Level Remote Switch RS-5LL K1007
- Drain Wizard Adapter Kit K1260+

+Limited Stock

BIG JOHN SUMP PUMPS

Heavy duty submersible pumps for draining pools, sumps & tanks. Delivers large volumes of water. Epoxy-coated cast iron with nylon impeller.



- Little Giant 6-CIMR** 1/3 HP Manual Switch K1010
46 GPM @ 5' 1-1/2" Discharge
- Little Giant 6-CIA-RFS** 1/3 HP Automatic K1015
46 GPM @ 5' 1-1/2" Discharge
- Little Giant 10-CIA** 1/2 HP Automatic K1020
70 GPM @ 5' 1-1/2" Discharge
- Sump Pump Switch Repair Kit SPRK-1 K1021

LITTLE GIANT POOL COVER PUMPS



PCPK-N

- PCPK-N Cover Pump** 325 GPH @ 1' K1000
A ready-to-use kit that contains - pump w/18 ft. cord, garden hose adaptor for 1/4" outlet & 25 ft. of 1/2" tubing. **6/Case**
24/Case

- 1AA-18 Cover Pump** 170 GPH @ 1' K1002
- PCPK-1 Cover Pump** 205 GPH @ 1' K1003
- Multi-Purpose** 550 GPH @ 1' K1005
- 5-APCP Automatic Water Wizard** K1011



Maintenance Pump with Stabilization Plate
1200 GPH @ 1'

- APCP Cover Pump** K1001
1700 GPH @ 1'



5-APCP

MISC. SMALL SUBMERSIBLES

For Waterfalls, Gardening, Fountains & Recirculation



- Little Giant Pump **2E-N** w/ 6' Cord 300 GPH K1006
- Little Giant Pump **2E-38N-WG** w/ 15' Cord 300 GPH K1028
- Little Giant Pump **P-AAA-WG** w/ 15' Cord 120 GPH K1008

- Little Giant Water Garden Starter Kit #SK-WG-2** K1012

JACUZZI SERVICE & UTILITY PUMPS



K1054

Heavy duty non-corrosive thermoplastic construction.

PS-16 Sump Pump 1/6 HP	115V	ITEM NO. K1054
<i>20 GPM @ 5 Ft. w/25 Ft. Cord</i>		
EL50A-25 Sump Pump 1/2 HP (25 Ft. Cord)	115V	K1058

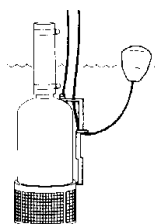

PCD-10B SUBMERSIBLE *H.D. Pool Drainer*

Cast Iron construction with brass base to prevent staining of pool floor. Weighs 34 lbs. Comes with automatic float switch & 25 ft. cord.

PCD-10B 1/2 HP Submersible Pump	K1086
<i>60 GPM @ 5' w/ 25' Cord</i>	

TRIDENT SUBMERSIBLE *Pool Drainer*

Automatic float switch cuts off when water level drops to 2" - 3" 5-1/2" diameter allows pump to fit inside most main drains.

Trident 3/4 HP Automatic Maintenance Pump	K3175
<i>77 GPM @ 5' w/ 20' Cord</i>	

TYPHOON UTILITY PUMP *Small Pool/Spa Drainer*

PSD2 Typhoon 1/6 HP Submersible Pump	K3178
<i>21 GPM @ 5' w/ 18' Cord</i>	

INDUSTRIAL STRENGTH

**NEW!!
TRASH PUMP**



KOSHIN SUBMERSIBLE PUMP

PKS-65011 HD Electric Submersible Trash Pump (2")	K1084
<i>110V, 7amp, 75 GPM @ 5' w/ 18' Cord</i>	
FS-10 Float Switch w/10' Cord for Sump Pumps	K1083
FS-20 Float Switch w/20' Cord for Sump Pumps	K1087

Gasoline Powered Trash Pump KTH-80X	K1085
<i>3" Trash Pump with 8 HP Honda Motor, 354 GPM</i>	



COVER CARE PUMP

Magnetically-driven & clog resistant, accommodates 3/4" garden hose

Pool Cover Pump w/ 25' Cord	300 GPH	K1022
Pool Cover Pump w/ 25' Cord	350 GPH	K1013
Pool Cover Pump w/ 25' Cord	500 GPH	K1018
Foam Prefilter for Models 350-500 Cover Care Pumps		K1113
Foam Prefilter for Model 1200 Cover Care Pumps		K1114



RULE COMPUTERIZED PUMPS

Pumps automatically only when water is present. No float switches

Rule Submersible Pump w/24' Cord(1")	1800 GPH	K1033
<i>w/ Freeze Protection & Stabilized Plate</i>		
Rule Submersible Pump w/24' Cord(1")	1800 GPH	K1024
Rule Submersible Pump w/24' Cord(1-1/4")	2800 GPH	K1025



Rule Pool Cover Pump Strainer Base for Cover Pump	K1352
Rule Replacement Handle for Cover Pump	K1354
Rule Strainer Base for Conversion to Utility Pump	K1356



BILGE PUMP

Small Plastic Hand-Powered Bilge Pump - 24" Long	K1016
Large Plastic Hand-Powered Bilge Pump - 36" Long	K1017
Replacement Hose w/End Caps - 1-1/4" x 24" Long	K1550
Replacement Hose w/End Caps - 1-1/4" x 36" Long	K1555

MONARCH

Trash Pump - 3" Discharge
Trash Pump - 2" Discharge

K1030*
K1031*

STA-RITE PORTABLE UTILITY PUMP



*A cast iron portable self-priming pump with 3 HP gasoline engine.
Includes non-clogging semi-open impeller with a 6" hair & lint strainer*

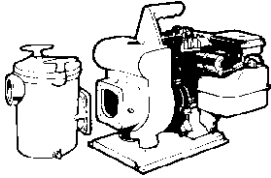

Sta-Rite EDPH 3 HP Service Pump K1065*

Gas Powered 151 GPM @ 10' - 87 Lbs.

#51 Cast Iron Hair & Lint Strainer H1140

**Non-Stock Item*

KOSHIN

Gasoline Powered Trash Pump KTH-80X
3" Trash Pump with 8 HP Honda Motor, 354 GPM

K1085



HI-VAC SUCTION HOSE (Bumble Bee)

Rugged, collapse-proof, flexible with leak-proof cuffs. Yellow & black design.

Without couplings

Hi-Vac Suction Hose (Bumble Bee)	2" x 25'	F2047
Hi-Vac Suction Hose (Bumble Bee)	3" x 20'	F2048
Hi-Vac Suction Hose (Bumble Bee)	3" x 25'	F2049



Above Hose has Brass Couplings

COUPLED PVC SUCTION HOSE

Heavy Duty Suction Hose	1-1/2" x 20'	F2040
Heavy Duty Suction Hose	2" x 20'	F2045
Heavy Duty Suction Hose	3" x 20'	F2055
Heavy Duty Suction Hose	3" x 25'	F2060

DISCHARGE HOSE - Regular

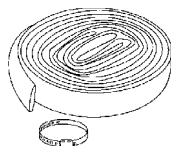

1-1/2" x 50'
1-1/2" x 200'
2" x 50'
2" x 200'

Regular Discharge Hose
Regular Discharge Hose
Regular Discharge Hose
Regular Discharge Hose

ITEM NO.
F2000
F2005
F2009
F2010

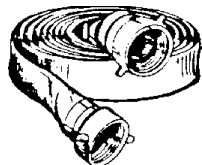

1-1/2" x 300'
2" x 300'
3" x 300'

DISCHARGE HOSE - Heavy Duty

Heavy Duty Discharge Hose
Heavy Duty Discharge Hose
Heavy Duty Discharge Hose

F2025
F2030
F2035



Above Hose No Couplings - Cut Sizes Available - Call for Price

Nylon Reinforce Vinyl

HOSE ACCESSORIES

Brass Couplings

1-1/2" F2070
2" F2071
3" F2072



Washers

1-1/2" F2075
2" F2076
3" F2077

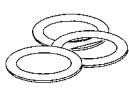

Plastic Male Adapters

1-1/2" F2061
2" F2062
3" F2063



Metal Hose Strainers

1-1/2" F2085
2" F2086
3" F2087



Spanner Wrench

1-1/2" F2080
2" F2081
3" F2082



Insert Couplings

1-1/2" U5015
2" U5020
3" U5025



PLASTIC QUICK DISCONNECT COUPLINGS

(A) Male x FPT

1-1/2" F2103
2" F2108
3" F2116



(B) Female x MPT

1-1/2" F2102
2" F2107
3" F2114

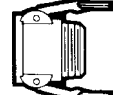

(C) Female x Insert

1-1/2" F2100
2" F2105
3" F2110

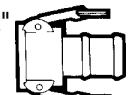

(D) Female x FPT

1-1/2" F2111
2" F2113
3" F2117

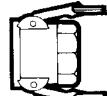

(E) Male x Insert

1-1/2" F2101
2" F2106
3" F2112

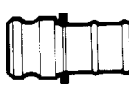

Q.D. Hose Washers

1-1/2" F2073
2" F2074
3" F2078

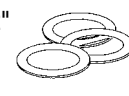

(F) Male x MPT

1-1/2" F2095
2" F2096
3" F2118



Handles

1-1/2" Handle F2104
2" Handle F2109
3" Handle F2119

HOSE CLAMPS - Stainless Steel (sold in boxes of 10)

CLAMP NO.		#6	#12	#16	#20	#24	#28	#32	#36	#52	#80	#104
Micro	Micro											
PIPE SIZE												
3/8" 1/2"	3/8"	3/4"	1"	1-1/4"	1-1/2"	1-1/2"	2"	2"	3"	5-1/2"	6"	
ITEM NO.												
F1207 F1208	F1206	F1212	F1216	F1220	F1224	F1228	F1232	F1236	F1252	F1280	F1297	

POOL SURFACE CLEANERS



Pumice Stone

Tile & concrete cleaner

		ITEM NO.
Pool Block - Pumice Stone	6" x 1-3/4"	A6102
Pool Block - Pumice Stone	6" x 3"	A6104
Pool Block - Scouring Stick	4 oz.	A6103
Pumice Stone for Tele-Pole	6 oz.	A6101

GARDEN HOSE

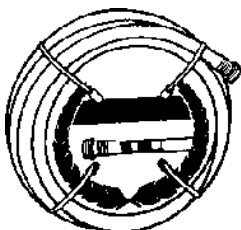

3/4" x 50' Garden Hose with Brass Couplings	F2130
3/4" x 100' Garden Hose with Brass Couplings	F2140
3/4" x 250' Garden Hose Only (400# Test)	F2145

Garden Hose Accessories



F2152

F2150

3/4" Female Hose Coupling Plastic	1F	F2150
3/4" Male Hose Coupling Plastic	1M	F2152

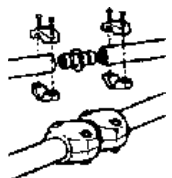

F2153



F2159

3/4" Hose Mender	1HM	F2153
3/4" Quick Coupling Set Brass	9QC	F2154
3/4" H.D. Brass Coupling Set		F2164
3/4" H.D. Brass Coupling Set LD		F2166



V7063



2158

3/4" Nylon Shut Off Valve	7V	F2156
3/4" Garden Hose Nozzle Plastic	474	F2158
3/4" Hose Nozzle Heavy Duty	571TFR	F2159
3/4" Garden Hose Nozzle - Metal	573	F2172

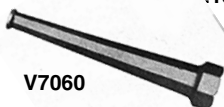

V7060

3/4" Fire Dept Type Wash Down Nozzle	V7061
1-1/2" Fire Dept Type Wash Down Nozzle	V7063



F2180



F2154

3/4" Water Jet Nozzle	F2180
3/4" PVC Swivel Adapter w/Washer MPT x FHT	F2170
3/4" PVC Swivel Adapter w/Washer FPT x FHT	F2171



F2162



F2161

Garden Hose Hanger Aluminum	F2160
3/4" Y Connector with Dual Valves	F2161



F2156

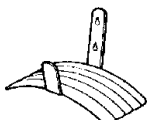

F2160

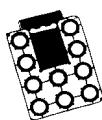

F2178

3 Hose Washers with Screen	2FW	F2162
3/4" Garden Hose Cap Plastic		F2176
Box of 10 Garden Hose Washers		F2178
Water Timer - Measures in Gallons	#9200	F2182
Quick Coupler Set w/Shut Off Valve		F2155
Plastic Quick Coupler Set 3/4" MGHT/FGHT		F2157
Fire Nozzle Brass 1-1/2"		F7060

LADDERS - Residential

Standard grade ladder made of 1.90" O.D. x .049" wall stainless steel.



	ITEM NO.
2-Tread Straight Ladder with Black Plastic Treads	G7000
3-Tread Straight Ladder with Black Plastic Treads	G7005
4-Tread Straight Ladder with Black Plastic Treads	G7010
3-Tread Safron PVC Ladder	G9005
2-Tread Straight Ladder with Stainless Steel Treads	G7015
3-Tread Straight Ladder with Stainless Steel Treads	G7020
4-Tread Straight Ladder with Stainless Steel Treads	G7025



LADDER - Deluxe

Recommended for light commercial & residential pools. Electro Polished ladders are made of 1.7 O.D. x .049" wall with rail end flared to 1.90" O.D. S.S. to fit in existing anchor sockets. Positive size smaller diameter grips are a safety feature for children, elderly, and disabled individuals.

3-Tread Deluxe Ladder with S. S. Treads	H9526
3-Tread Deluxe Ladder with Plastic Treads	H9720



LADDERS - Commercial

Heavy Duty & Cross-Braced

Both ladder types are recommended for heavy duty commercial use at public & institutional pools. All ladders are made of 1.90" O.D. x .065" wall stainless Steel & come with ladder bumpers to prevent damage to the pool wall. Ladders with cross braces offer extra rigidity & strength.

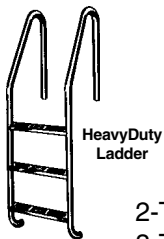

Heavy Duty Ladder

2-Tread Heavy Duty Ladder - 24" Width	G7016
3-Tread Heavy Duty Ladder - 24" Width	G7021
4-Tread Heavy Duty Ladder - 24" Width	G7027
2-Tread Heavy Duty Ladder - 24" w/ Cross Brace	G7017
3-Tread Heavy Duty Ladder - 24" w/ Cross Brace	G7023
4-Tread Heavy Duty Ladder - 24" w/ Cross Brace	G7026
3-Tread Safron Heavy Duty Ladder - 24" w/ Cross Brace	G9023
4-Tread Safron Heavy Duty PVC - 24" w/ Cross Brace	G9026

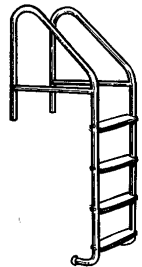

Heavy Duty Ladder with Cross Brace

SAFE-T-POOL STEPS

Tread is 8" Wide, over twice as wide as conventional treads. Helps keep kids safe!
Kit includes ladder steps, two side skirts, rubber bumpers & bolt kit

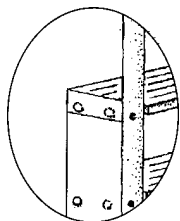

Safe-T-Kit (2-Step) - Residential Kit	G7009
Safe-T-Kit (3-Step) - Residential Kit	G7007
Safe-T-Kit (3 Step) - Commercial Kit	G7013
Safe-T-Kit (4 Step) - Commercial Kit	G7018



SAFRON

Safron High Impact Vinyl Ladders are reinforced internally with fully encapsulated steel for a tough, beautiful looking product that will enhance your pool for many years while requiring virtually no maintenance.

No Grounding and/or Bonding Necessary.

Available in many colors!

Some in stock- Listed throughout the rail goods section with similar S.S. products.

Special order - Please Call

STANDARD HANDRAILS

Allows safe entry & exit from the pool

"All Astral Rails are Electro Polished"

2-Bend Rail

- 48" Hand Rail 2-Bend
- 48" Astral Hand Rail
- 60" Hand Rail 2-Bend
- 60" Astral Hand Rail
- 60" Saffron Rail White
- 72" Hand Rail 2-Bend
- 72" Astral Hand Rail

	(.049 Thickness)	(.065 Thickness)
48" Hand Rail 2-Bend	G7075	----
48" Astral Hand Rail	G8075	----
	G9075	
60" Hand Rail 2-Bend	G7080	----
60" Astral Hand Rail	G8080	----
60" Saffron Rail White	G9080	
72" Hand Rail 2-Bend	G7085	----
72" Astral Hand Rail	G8085	----

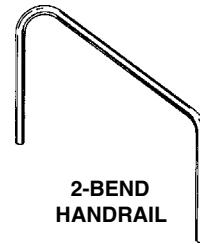

2-BEND HANDRAIL

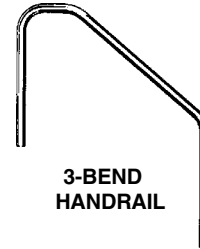

3-BEND HANDRAIL

3-Bend Rail

- 48" Hand Rail 3-Bend
- 60" Hand Rail 3-Bend
- 60" Saffron (White)
- 66" Astral (3 Bend) Rail
- 72" Hand Rail 3-Bend
- 72" Astral 3-Bend
- 72" Saffron (White)
- 84" Hand Rail 3-Bend
- 96" Hand Rail 3-Bend

	(.049 Thickness)	(.065 Thickness)
48" Hand Rail 3-Bend	G7076	G7096
60" Hand Rail 3-Bend	G7081	G7097
60" Saffron (White)	G9081	
66" Astral (3 Bend) Rail	G8082	
72" Hand Rail 3-Bend	G7083	G7091
72" Astral 3-Bend	G8083	
72" Saffron (White)	G9083	
84" Hand Rail 3-Bend		G7087
96" Hand Rail 3-Bend	G7088*	G7089

**Non-Stock Item*

DECK MOUNTED STAIR RAILS

Horizontal

- Center Grab Rail - 51" (.049")
G7392
- Center Grab Rail - 51" (.065")
G7394 (Commercial)
- Saffron Fig. 4 Grab Rail (White) - 48"
G9063

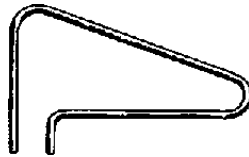

Sloping - Welded

- Center Grab Rail- 54" (.049")
G7092

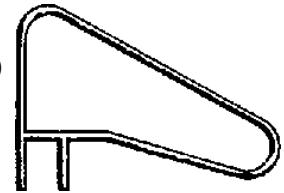

Horizontal - Flat Top

- Center Grab Rail - 48" (.049")
G7090
- Center Grab Rail - 48" (.065")
G7390*



Deck Level - Pair

- 30" Rails G7073
- 36" Rails G7072
- 42" Rails G7095

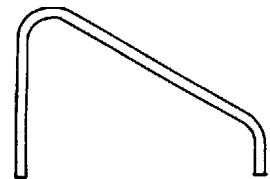

**Non-Stock Item*

ASTRAL STAIR RAILS w/ Flared Ends

Electro-polished 1.7" O.D. S.S. rails with flared ends to 1.9" O.D. to allow replacement of existing rail. Smaller diameter frame allows easier & safer grip for small or wet hands, providing extra safety.

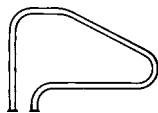
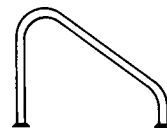
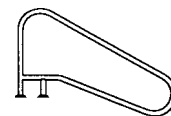

Figure 4 Rail
G8090



Hand Deck Rail 36" (Set of 2)
G8072 (G8073* 30")



Cross Braced Stair Rail
G8092

**Non-Stock Item*

SPA RAIL



Spa Rail (1-5/8" O.D. x .049" Wall) - Bolts Not Included

G7069

Rail supplied with 4" x 10" Plate drill for 3/8" Bolts and has a welded bottom

PAIR FIGURE 4 HANDRAILS

Made of 1.90" O.D. x .049" or .065" wall. S.S. mirror finish

Pair of Fig. 4 Handrails (.049 Wall) 26"	ITEM NO. G7063
Pair of Astral 1.7 Fig. 4 Grab Rails	G8063
Pair of Fig. 4 Handrails (.065 Wall) 30"	G7093

Powder Coated Color Rails

Pair of Fig. 4 Handrails (Copper Vein Color) Includes Escutcheons	G7078*
--	--------

Textured white, earth tone, patina & black
Also available by special order

SAFTRON P-330 Fig. 4 White Vinyl Grab Rail w/White Escutcheons	G9065
---	-------

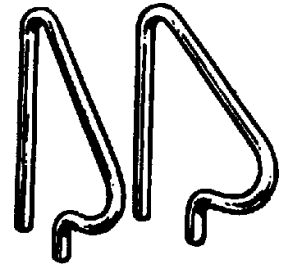

Pair Fig.4 Handrails



PAIR OF GRAB RAILS

With Brass Anchors

Residential Ring Rails - Pair (1-5/8" O.D. x .049")	G7068
Commercial Ring Rails - Pair (1.625" O.D. x .065")	G7086*



G7068

Residential Ring Rails Only (No Anchors)	G7062
Double Anchor Assy Only - Bronze for Grab Rails	G7077
SAFTRON P-329 PVC - White Vinyl Ring Rail	G9067



G7077

RECESSED STEPS

S.R. Smith Recessed Plastic Step - Each - Baja	(White)	G7041
S.R. Smith Baja Recessed Steps - Each	(Black)	G7042
Am Products Recessed Plastic Steps 16-1/2" - Set of 3	(White)	G7064
Am Products Recessed Plastic Steps 16-1/2" - Set of 3	(Blue)	G7065
Waterways Recessed Steps 15" Wide - Set of 3	(White)	G7067
Waterways Recessed Steps 15" Wide - Set of 3	(Blue)	G7066
Waterways Recessed Steps 15" Wide - Set of 3	(DarkGrey)	N5146*
Waterways Recessed Steps 15" Wide - Set of 3	(LightGrey)	N5145*
Waterways Recessed Steps 15" Wide - Set of 3	(Black)	G7057*

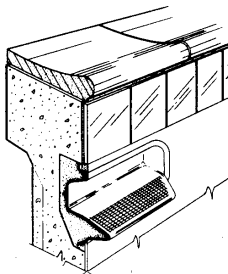

*Non-Stock Item

EXERCISE BARS

1.90" O.D. x .049" wall, 304 stainless steel tube with mirror finish.
S.S. hardware included with mounting flanges (set of 3) #60-718.
Custom dimension rails available by special order

2' Exercise Bar w/Flanges	G7172*
3' Exercise Bar w/Flanges	G7174
4' Exercise Bar w/Flanges	G7176
5' Exercise Bar w/Flanges	G7178
Anchor Stud Kit 3/8"	G7173

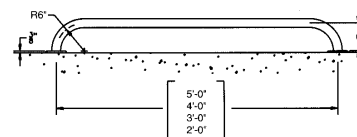

LADDERTREADS

Measure from Center to Center of Ladder Rails



G7055

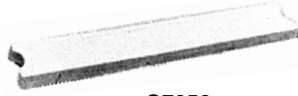

G7056



G7046



G7098



G7048



G7044

19" Plastic Tread - Swan LTFDF-101	ITEM NO.	G7055
19" Plastic Tread - Paragon - Vertical Ladder		H1229
19" Plastic Tread - Paragon - 15 Degree Slope		H1230
Sylvan Plastic Tread - 15 Degree Slope		Z5000
20" Plastic Tread - Swan A42073-0 H.I.P.		G7056
20" Plastic Tread - Swan A42077-0 Blow Molded		G7046
20" Stainless Steel Tread - Astral Deluxe 1.9 Ladder		H9756
20" Stainless Steel Tread - Astral Deluxe 1.7 Ladder		H9757
Ladder Tread - Plastic - Non-slip surdace		G7047
20" Stainless Steel Tread - Swan LTDF-103 Elite		G7098
20" Stainless Steel Tread - Swan - 15 Degree Slope		G7053
22" Plastic Tread, White- Swimquip - 15 Degree Slope		G7045
26" Plastic Tread - Paragon - Vertical Ladder		G7044
26" Plastic Tread - Paragon - 15 Degree Slope		G7051
Stainless Steel Ladder Bolt w/Nut (2-1/2") - 6/Bag		G7058
Stainless Steel Ladder Bolt w/Nut (3-1/4") - 6/Bag		G7059
Inter-Fab S.S. Ladder Bolt Kit w/Nut & Washer - 6/Bag		G6999
Hex Nut Only, S.S. 5/16" for Ladder Bolt		G7049
Bag of 2 Male Ladder Bumpers		G7052
Black Non-Skid Pad for Non-Skid Tread		H1247
Female Ladder Bumper		G7054

ANCHOR SOCKETS

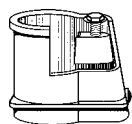
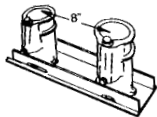
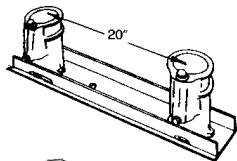
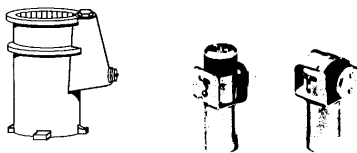

Anchor Socket 1.9 O.D. - Brass	G7115
Anchor Socket 1.625 O.D. - Brass	G7109
Anchor Socket 1.9 O.D. - Aluminum	G7100
Anchor Socket 1.65 O.D. - Aluminum	G7105
Anchor Socket 1.9 O.D. - Astral - Fiberglass	H9525
Plastic Anchor Socket -1.9 OD - Perma Cast	G7115P
Saftron Anchor Socket - Plastic	G7101
Hinged Ladder Anchors - Pair (A-41657)	G7108
Hinged Ladder Anchors Perma Cast - Pair (JH-0019)	G7112
2 Aluminum Sockets Mounted on Steel Channel 20"	G7120
2 Aluminum Sockets Mounted on Plastic Channel 20"	G7117
2 Aluminum Sockets Mounted on Plastic Channel 8"	G7118+
2 Brass Sockets Mounted on Steel Channel 20"	G7121
2 Brass Sockets Mounted on Steel Channel 8"	G7119
2 Plastic Sockets On 20" Channel on Steel	G7121P
2 Plastic Sockets On 8" Channel on Steel	G7119P
Wedge, Screw & Washer - Standard	G7122
Wedge, Screw & Washer - Hayward Brass SP-392-BA	G7124
Wedge, Screw & Washer - Hayward Plastic SP-1392-CA	G7126
Wedge, Screw & Washer - Olympic JA17	G7149
Wedge, Screw & Washer - Saftron	G7104
Wedge Assy - KDI Paragon Brass	G7127
Wedge Assy - Frost Bronze	G7123
Double Wedge - Swan Gibraltar w/ Bolt & Bar	G7129
Double Wedge - Swan Gibraltar Retrofit Kit	G7139B
Deck Anchor Repair Plate - S3413-1001	G7107

Tightens loose rails where wedges are worn

+Limited Stock

ESCUTCHEON PLATES



G7125



G7131

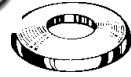

G7162



G7132



G7139A

		ITEM NO.
Escutcheon Plates - Key Shaped Chrome-Brass	(Bag of 2)	G7125
Escutcheon Plates - Key Shaped Stainless Steel	(Bag of 2)	G7131
Escutcheon Plates - Round Stainless Steel	(Bag of 2)	G7130
Escutcheon Plates - Round White Plastic	(Bag of 2)	G7140
Escutcheon Plate - Hayward SP1041	(Each)	G7142
Escutcheon Plates - Round Chrome-Plastic	(Bag of 2)	G7145
Escutcheon Plate - Snap-Tite (2 Pc) Chrome-Plastic	(Each)	G7160
Escutcheon Plate - Snap-Tite (2 Pc) White Plastic	(Each)	G7162
Escutcheon Plate - Double Anchor S.S. (Swan)	(Each)	G7132+
SR Smith 8-420 Double Escutcheon Retro Kit# G7139	(Each)	G7139A
SR Smith 8-415A Gibraltar Wedge Retro Kit# G7139	(Each)	G7139B

+Limited Stock

DECK ANCHOR FLANGES



G5132



G5130

Plastic Deck Flange for 1.5" O.D. Rail (3-Hole)	(Bag of 2)	G5135
White Aluminum Deck Flange for 1.5" O.D. Rail (3-Hole)		G5131
Plastic Deck Flange for 1.90" O.D. Rail (4-Hole)		G5132
Plastic Deck Flange for 1.90" O.D. Rail w/Hardware (4-Hole)		G5134
Interfab S.S. Deck Anchor Flanges		G7103
Hardware Only for Plastic Deck (4-Hole) Flange		G5139
White Aluminum Deck Flange 1.90" O.D. Rail (4-Hole)		G5133
White Aluminum Deck Flange 1.90" O.D. Rail (Center Hole)		G5130
White Aluminum Deck Flange 1.625" O.D. Rail (Center Hole)		G5137
Interfab #H-107 Deck Anchor Flange for slide		G7103

STANCHIONS

For supporting backstroke lines, finish lines & recall lines.
Made of S.S. tube capped at one end w/closure plate & U-hook.

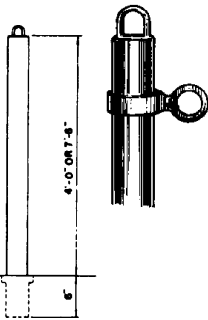

Stanchion Post - Short Recall (False Start) (4' - 6")	G7152
Stanchion Post - Backstroke (8')	G7154
Sliding Collar with Eyebolt for Stanchion Post	G7156

STANCHION ANCHOR SOCKETS

For stanchions & water polo goals.

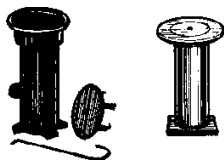

S.S. Stanchion Anchor Socket with Slip Fit Cap	G7150
Bronze Stanchion Anchor Socket with Threaded Cap	G7133
Bronze Stanchion Anchor Socket with Slip Fit Cap	G7146
S.S. Slip Cap Cover Only for S.S. Stanchion Anchor	G7144
Bronze Slip Cap Cover Only for Stanchion Anchor	G7141
Bronze Threaded Cap Cover for Bronze Stanchion Anchor	G7137
Key Only for Bronze Anchor Socket with Threaded Cap	G7134

BACK STROKE FLAGS



Economy Back Stroke Flags	
Blue & White (12" x 18") Pennants - 100' Line	G7138
Custom Back Stroke Flags	
H.D. Vinyl Strung on Polypropylene Cord - Per Foot	G7158*
<i>Available in Team Colors; Letters in Gold & White</i>	
<i>Per Printed Letter* Per Foot of Extra Line*</i>	

*Non-Stock Item



anti wave
RACING LANES

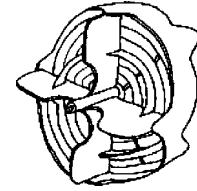

“ForeRunner”

*New state-of-the art 4.75" racing lanes with Hydrodynamic Propulsion.
Undulating shape of outer rim causes wave to be deflected downward, leaving no wake on either side.
Uses 20 strand S.S. cable with 2,000 Lb. test. All lanes are fitted with Supertensioner reel.*

4.75" RACING LANES

		ITEM NO.
20 Yard	(60 Ft.) Anti-Wave ForeRunner Racing Lane - Assembled	X1159*
25 Yard	(75 Ft.) Anti-Wave ForeRunner Racing Lane - Assembled	X1160*
25 Meter	(82 Ft.) Anti-Wave ForeRunner Racing Lane - Assembled	X1165*
50 Meter	(165 Ft.) Anti-Wave ForeRunner Racing Lane - Assembled	X1170*
25 Yard	(75 Ft.) Anti-Wave Mini Racing Lane - Unassembled	X1171*
25 Meter	(82 Ft.) Anti-Wave Mini Racing Lane - Unassembled	X1172*
50 Meter	(125 Ft.) Anti Wave Mini Racing Lane - Unassembled	X1173*

* Prices are NET F.O.B. Sayer, TX.

*Standard Disc Colors: Red, Blue, White, Green, Yellow, Black, Orange, Teal & Light Gray
Float Colors: Red, Blue, White, Green & Yellow
Supertensioner Colors: Red, Blue, White, Green, Yellow & Black
Please Specify Color Requirements with Order*

ANTI-WAVE LANE STOREELS

“Ultimate” Maxi Size Storeel	X1155*
<i>Made from 1 - 1/4 Powder Coated Aluminum and Stainless Steel Holds up to 8-75 Foot ‘Forerunner’ Lanes or 5-75 Foot ‘Maximum’ Lanes.</i>	
Cover for Ultimate Reel	X1180*
Mesh Cover for Ultimate Reel	X1153*
Storeel Cover Only - Vinyl <i>(For “Classic” Reel)</i>	X1157*



TENSION REELS & WRENCHES



Supertensioner Reel

“Supertensioner” Reel	X1174
Ratchet Tension Reel <i>(Obsolete)</i>	X1152+
Wrench	X1185+
	+Limited Stock

Racing Lane Parts & Components

S.S. Cable (Anti-Wave) - Per Foot	X1151*
2" S.S. Extension Hook	X1154
Disc - State Color (Anti-Wave)	
3" S.S. Extension Hook	X1158
Float, White - Large (Anti-Wave)	
8" S.S. Extension Hook	X1149*

STAINLESS STEEL STORAGE REEL

Constructed of electropolished stainless steel, roller is easily portable and features a towing handle. Roller can accommodate up to 500 feet of racing lanes. Holds 6 x 25 yard/meter or 3 x 50 yard/meter lanes.

Stainless Steel Storage Reel - Astral

X1184

*Non-Stock Item

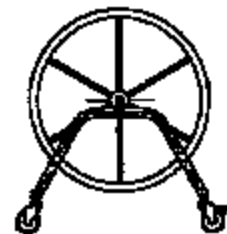

COMPETITOR RACING EQUIPMENT



* Prices are NET
F.O.B. Medina, OH

RACING LANES (4" Diameter)

Competitor Racing Lanes consists of a series of 4" polyethylene disks and donuts assembled on vinyl coated, stainless steel cable.

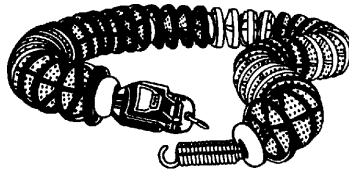

STANDARD COLORS: White, Red, Yellow, Blue & Green

	ITEM NO.
60' Racing Lane - Fully Assembled	X1143*
75' Racing Lane - Fully Assembled	X1144*
25 Meter Racing Lane - Fully Assembled	X1145*
50 Meter Racing Lane - Fully Assembled	X1146*
Special Order Lane Per Foot & Hardware (1 lb. per ft)	X1147*

STORAGE REEL

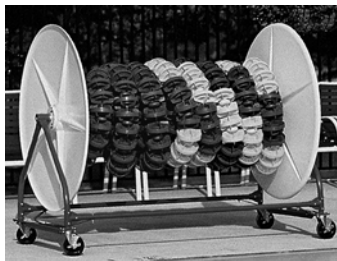

Holds up to 540 Ft. of 4" Diameter Racing Lanes.
Framework constructed of electroplated aluminum which supports thermo-formed plastic reel assembly

Stor-Lane Reel	X1400*
Reel Cover - Vinyl	X1410*

Parts

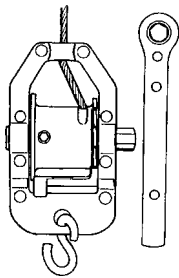

Ratchet Take-Up Reel (Includes Cover)	X1168
Reel Cover (Red)	X1167
Wrench for Take-Up Reel - 5/8" - 12 Point	X1177
S.S. Spring & Cable Lock	X1176
2" Extension Hook	X1183
S.S. Cable Lock	X5001
3/16" S.S. Vinyl Coated S.S. Cable, per ft	X1169
Body Segment (approx 4 per ft)	X1178*
End Segment (approx 4 per ft)	X1179*

PACE CLOCKS

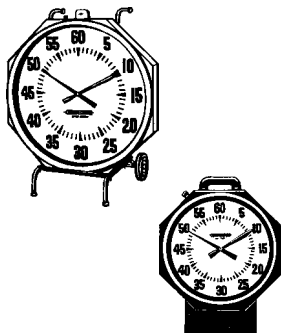

31" Pace Clock - Wall Mount - Battery Model	X1450*
31" Pace Clock - Wall Mount - Electric Model	X1452*
31" Pace Clock - Portable with Stand - Battery Model	X1454*
31" Pace Clock - Portable with Stand - Electric Model	X1456*
15" Red Pace Clock - Battery Model	X1458*
15" White Pace Clock - Battery Model	X1460*

*Non-Stock Item

**All Items On This Page Are Special Order Non-Stock Items- Add Freight*



Paragon Competitor Model

Dual legs give greater stability. Uses Competitor Anchor System Only. Anchor assembly is included (Price Includes Anchor)

Competitor Start Platform
G8015*

Competitor Anchor 23103 Only
G7136*



Paragon Track Start Model

Features 24" by 32" top now used by many competitive swimmers. Anchor assembly is included (Side Mount Model Shown)

Track Start Competitor
G8023*

Anchor Model 23103 Only
G7136*



Paragon Standard Model

Fits most pools except those with unusual features. Top platform can be set level or tilted towards pool. Anchor assembly is included

Standard "Quickset" Platform
G8020*

Quickset Anchor 23301 Only
G7135*

SR Smith Inc.



SR Smith Legacy Starting Platform

Legacy starting platforms constructed of high strength electropolished S.S. with fiberglass slip resistant top. Will fit most existing single post anchors. Special ordered to fit almost any height variable.

Legacy Platform w/Anchor
G8002*

Legacy Platform w/out Anchor
G8004*

Anchor Only for Legacy Platform
G8008*



SR Smith Legacy II Starting Platform

Constructed of 1.90" diameter S. S. tubing with large fiberglass top surface. Will fit most existing dual post anchor systems. Available with or without anchors & available in almost any deck & water height variable.

Legacy II Starting Platform
G8006*

ASTRAL



Astral Standard & Deluxe Model Platform

New Tube design offers best design features at competitive prices. Constructed of electropolished stainless steel with 24" x 24" fiberglass top. Platform is easily installed or removed from anchor.

Std. Platform 18" Height	G8030*
Deluxe Platform 18" Height	G8010*
Deluxe Platform 24" Height	G8000
Florida Style 24" Height	G8040*



(*Non-Stock Item)
F.O.B. Mfg. Plant

WARNING!

Starting Platforms are to be used by trained competitive swimmers only. Shallow racing dives only should be executed. Impact with the pool bottom can cause serious injury. Please refer to applicable codes and regulations for your specific installation.

PORTABLE POOL BASKETBALL



Dunn-Rite Splash & Slam B100

ITEM NO.
Y2180

State-of-the art pool basketball set. *Fiberglass backboard has 2' of overhang. The vinyl coated, steel rim easily adjusts anywhere from 2' to 6' above water level. Includes super tough polyethylene base that weighs 500 lbs. when filled with water.*

Features unique hinged breakaway system to protect players & the unit during rough play

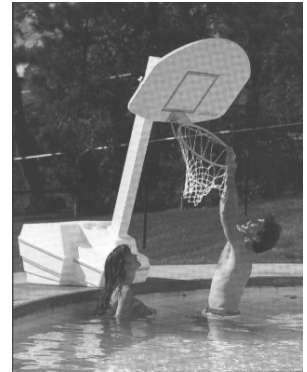

- | | |
|------------------------|-------|
| Replacement Basketball | Y2208 |
| Replacement Net | Y2202 |
| Backboard Only | Y2200 |
| Rim Only | Y2201 |

Optional H.D. Slam Combo C204

Y2186* add freight

Kit converts above Splash & Slam unit into a regulation water volleyball set. *Includes (1) matching 500 lb. base, 32' net with extension rope to accommodate a 70 ft pool.*

SlamVolly Portable Pool Volleyball Set SLV200

Y2188* add freight

Commercial size pool volleyball set includes (2) heavy duty aluminum posts, 32' net with 40' extension rope and hot colored ball. Molded polyethylene bases weigh 500 lbs. each when filled with water. Easy to assemble.

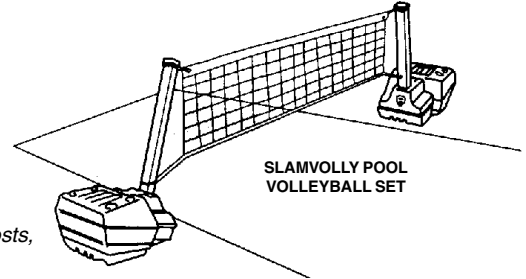

SLAMVOLLY POOL VOLLEYBALL SET

*Non-Stock Item
-Add Freight



SWIM N' DUNK

Basketball Game

Designed for in-ground pools in water depths not to exceed 42". *Constructed of 1.90 S.S. uprights w/acrylic backboard & basketball. Bronze anchors required (Order Separately).*

Swim N' Dunk Basketball Game G6000

SWIM N' SPIKE

Volleyball Game

Standard game designed for pools between 15' to 20' wide. Includes two 1.90 S.S. posts w/ removable eyebolts to anchor the net. Includes competitive water volleyball. Bronze Anchors required (Order Separately).

Swim N' Spike Volleyball Game G6005

S.R. Smith Inc.



*Non-Stock Item
-Add Freight

ROGUE FUNSLIDE**S.R. Smith Inc.*****For Residential Use Only***

Tall 8 Ft height recreational slide intended for moderate to heavy-duty use on residential in-ground pools. Features durable acrylic runway w/four straight legs & advanced water delivery system. Easy to install & adjust. (Does not include deck flange hardware.)

		ITEM NO.
Rogue Slide - Right Curve - Complete w/Ladder Package	White	G3150
	Blue	G3155
Rogue Slide - Left Curve - Complete w/Ladder Package	White	G3160
	Blue	G3165

*Designer colors available by special order - Add 10%
Rogue Slide replaces Frontier III Slide*

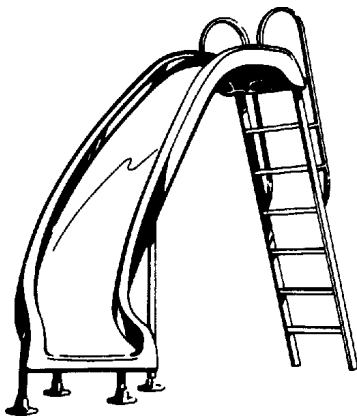
**Parts & Accessories**

Rogue Ladder Assembly - Complete	G3170
Frontier III Ladder Assembly - Complete	G3171*
Handrail for Slide - Fits Frontier II (Each)	G3190
Frontier III Hose Kit w/ Fittings	G5145
Slide Replacement Parts Kit Fits Frontier II	G5110
Plastic Garden Hose Fitting Only	G5151
Gel-Gloss Fiberglass Cleaner - Pint	G5100

SWIM CLUB II FUNSLIDE***For Commercial & Residential Pools***

Intended for moderate to heavy duty use on in-ground residential & commercial pools. Features scratch resistant acrylic construction complete w/ladder package & 2 U-frame S.S. legs. Must be installed in deck. Bronze anchors & flanges are ordered separately.

NOTE- Slides and Ladder Assembly Priced Separately



Swim Club Series Runway - 8' Curve Left	G3175*
Color: White*	
Swim Club Series Runway - 8' Curve Right	G3176*
Color: White*	
Slide Ladder & Parts Carton	G3177*

**Available in tile blue, radiant white & marine blue.
Designer colors available by special order - Add 10%*

**Non-Stock Item
- Add Freight*

Not All Slides Stocked

INTER-FAB

WILD RIDE SLIDE

6' - 6" high at seating area. Acrylic runway with stainless steel legs & handrails. Features Zoom Flume water system, deep runway & closed toe molded steps for safety. Slides are packed complete in one carton.



Wild Ride Slide - Curve Right Color: **White**

Complete w/ Step & All Hardware

ITEM NO.

G3125

Wild Ride Slide - Curve Left Color: **White**

Complete w/ Step & All Hardware



G3135

Zoom Flume

WHITE WATER SLIDES

4' High. Safe, durable, fun & stylish. Zoom Flume delivery system, action from 4 Jets. Unique molded steps. Acrylic surface.



White Water Slide - Curve Right Color: **White**

Complete w/ Step & All Hardware

G3120

White Water Slide - Curve Left Color: **White**

Complete w/ Step & All Hardware

G3130

Deck Anchor - Stainless Steel (Optional) - Each

for White Water & Wild Ride Slides

G7103

ZOOMERANG SLIDE

Compact 3' size designed for both above ground pools with decks & residential in-ground pools. Features Zoom Flume water system.



Zoomerang Slide - Curve Right (Left not available)

Complete w/ Ladder & All Hardware

G3127

SLIDE ROCK SLIDE

Natural colored 4' acrylic slide, enclosed in simulated rock formation.



Slide Rock Complete - Curve Right Color: **Tan**

Includes front & rear rock panels, runway, steps, copper vein, hand rails, stainless steel legs, stainless steel anchors, stainless steel hardware & plumbing

G3142*



XSTREAM SLIDE

Xstream Slide - Curve Right or Curve Left

6'6" High. Fantastic water delivery system, stainless steel mounting hardware. Out performs everything else.

G3149*

**Non-Stock Item
NET PRICE
- Add Freight*

TRIAC SLIDES



Reinforced fiberglass slide with tough, acrylic finish to resist cracking, peeling & fading. Aluminum Ladder.

Priced to Sell
Check Price!

Triac Slide - Complete w/Ladder

Curve Right Color: **Blue**

G5305+

Curve Left Color: **Blue**

G5315+

+Limited Stock

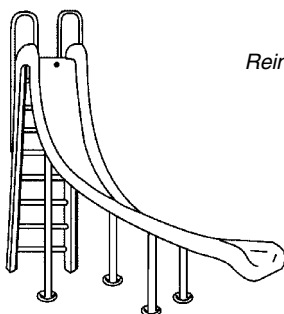

S.R. Smith Inc.



Reinforced fiberglass construction w/acrylic outside surface. Includes Jig.

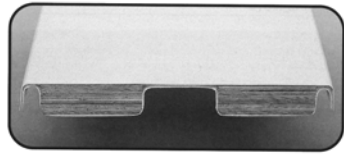

A quality board for home pools. Features two tapered wood runners laminated to an acrylic skin.

FLYTE-DECK II FIBERGLASS STAND

ITEM NO.

1/2 Meter Flyte-Deck II Stand for 6' Board	G3085
1/2 Meter Flyte-Deck II Stand for 8' Board	G3087
1/2 Meter Flyte-Deck II Stand for 10' Board	G3090
Complete Spring Assy #606 for 6' Board for G3065 Base	G3067
Complete Spring Assy #608 for 8' Board for G3065 Base	G3068
Steel Jump Stand W/ Jig (Spring not Inc.)	G3065
Jig only for 6' Flyte Deck Stand	G3086
Jig only for 8' Flyte Deck Stand	G3088
Jig only for 10' Flyte Deck Stand	G3091

FIBRE-DIVE BOARD

6' (AB-6) Diving Board - 18" Wide	G1000
(Drilled 10" on Center)	
6' Fibre Diving Board - 18" Wide	G3000
8' Fibre Diving Board - 18" Wide	G3002
10' Fibre Diving Board - 18" Wide	G3004
6', 8' & 10' Fibre-Dive boards with designer colors are now available by special order. F.O.B. Mfg. Plant.	

FRONTIER II & III

Frontier II boards intended for light to moderate duty use on residential pools. Frontier III designed for moderate to heavy duty use on residential pools.



6' (3-Hole) Frontier II Spring Board	G3008
8' (3-Hole) Frontier II Spring Board	G3009
6,8' (3-Hole) Frontier II Jig	G1068
6' Frontier II Spring Only w/ 3 Hole Jig	G3220
8' (3-Hole) Frontier II Spring w/ Jig	G3225
6' (2-Hole) Frontier III Spring Board	G1033
8' (2-Hole) Frontier III Spring Board	G1038
12' Frontier III Diving Board - 18" Wide	G3006

GLASS-HIDE

An all-purpose board made for diving pleasure with an attractive appearance. Fiberglass covering with solid laminated wood core. Designed for use in all climates - on private pools.

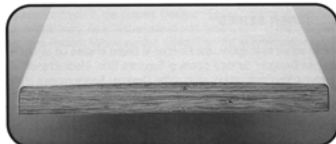

6' Glas-Hide Diving Board - 18" Wide	G3010
8' Glas-Hide Diving Board - 18" Wide	G3012
10' Glas-Hide Diving Board - 18" Wide	G3014

COMMERCIAL

Heavily reinforced with fiberglass encasing the laminated wood core, plus additional fiberglass reinforcing at the fulcrum area. (Ideal for hotels, motels & public pools)



10' Commercial Diving Board - 18" Wide	G3018
12' Commercial Diving Board - 18" Wide	G3015
14' Commercial Diving Board - 20" Wide	G3020
16' Commercial Diving Board - 20" Wide	G3025

ALUMINUM

Recommended for commercial pools. Exceptional durability & outstanding action. Proven "I" beam extrusions are epoxy glued with welded end construction. Safe non-slipsurface resists wear.



8' Aluminum Diving Board - 18" Wide	G3030
10' Aluminum Diving Board - 18" Wide	G3035
12' Aluminum Diving Board - 18" Wide	G3040
14' Aluminum Diving Board - 20" Wide	G3045
16' Aluminum Diving Board - 20" Wide	G3050

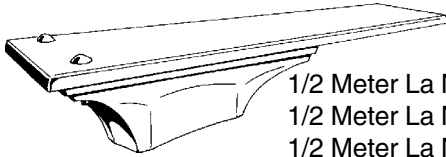

LA MESA DIVE STANDS

INTER-FAB

1/2 Meter La Mesa Dive Stand for	6' Board	(White)	G3083
1/2 Meter La Mesa Dive Stand for	8' Board	(White)	G3089
1/2 Meter La Mesa Dive Stand for	10' Board	(White)	G3092
1/2 Meter La Mesa Dive Stand for	6' Board	(Tan)	G3083T
1/2 Meter La Mesa Dive Stand for	8' Board	(Tan)	G3085T
1/2 Meter La Mesa Dive Stand for	8' Board	(Black)	G3089B*
La Mesa Dive Mounting Jig for	6' Board		G3111
La Mesa Dive Mounting Jig for	8' Board		G3112
La Mesa Dive Mounting Jig for	10' Board		G3114

DURO-BEAM DIVE BOARDS

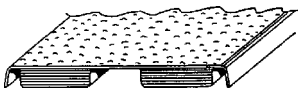

Two laminated beams running the length of the board encased in fiberglass with acrylic skin

6'	Duro-Beam Diving Board	(White)	G3001
8'	Duro-Beam Diving Board	(White)	G3005
8'	Duro-Beam Diving Board	(Black)	G3005B*
10'	Duro-Beam Diving Board	(White)	G3007
6'	Duro-Beam Diving Board	(Tan)	G3001T
8'	Duro-Beam Diving Board	(Tan)	G3005
	Dura-Beam Board Mounting Kit		G3250

*Non-Stock Item

T7



7' T7 Diving Board	(Gray)	G3003
T7 Springs w/ Spring to base S.S Mounting Hardware		G3036
T7 Base & Jig w/ Jig to base S.S Mounting Hardware		G3037
T7 Edgewater Waterfall Assembly		G3038
T7 Edgewater Waterfall Assembly w/ LED Lighting System		G3039
T7 Edgewater Waterfall Assembly w/ Fiber Optic Lighting		G3041

All Diving Board Prices Include Hardware

ANTHONY BOARDS

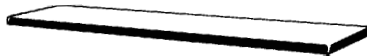

6' 3-Hole Special Anthony Board	G1030
8' 3-Hole Special Anthony Board	G1035
Hardware Only for Anthony Board	G1037

SR SMITH 606/608 Steel Jump Stand w/Jig (Spring not included) G3065

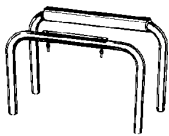

U-FRAME DIVE STANDS

18" Diving Board Stand-Box of 2 Rails	G3075
24" Diving Board Stand-Box of 2 Rails	G3080
24" Heavy Duty Board Stand - Box of 2 Rails	G3081

FULCRUM BUMPERS



20" Replacement Fulcrum Bumper-White for U-Frame	G3084
--	-------

DIVING BOARD RESURFACING KITS & SAFETY WALK

Epoxy kit for creating a non-skid surface on diving board



White	G1090
Blue Ice	G1091
AquaMist	G1092
Scotch Tread Cut to Size	G3110
Safety Walk 60' Roll/ 18" Wide	G3115
SR Smith Black Nonskid Pad for Ladder Tread	H1247

HARDWARE FOR DIVING BOARDS

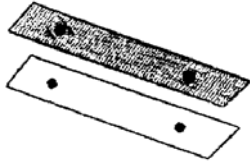

Standard Hardware for Residential Boards		G1027
4-1/2" Bolt & Nut for Diving Board	(Bag of 2)	G3059
5" Bolt & Nut for Diving Board	(Bag of 2)	G3058
5-1/2" Bolt & Nut for Diving Board	(Bag of 2)	G3060
6" Bolt & Nut for Diving Board	(Bag of 2)	G3063
1/2"-13 Nut-Hex Head		G3055
1/2" Washer - Flat		G3057
1/2" x 5" Carriage Bolt		G3064
Bolt Kit for Flyte Deck II Dive Stand	#71-209-710	G3021
Aluminum Hardware Mounting Kit - 18"		G3052
Aluminum Hardware Mounting Kit - 20"		G3051
Rubber Mounting Pad Only - 18"		G3054
Rubber Mounting Pad Only - 20"		G3053
Jig Prong Epoxy Repair Kit - Interfab (4 ea. 1/2" Bolts)		G3107
Jig Prong Epoxy Repair Kit - Interfab (3 ea. 5/8" Bolts)		G3108

Plastic Lifeguard Chairs

Special Order Only

Lifeguard Chairs come complete with:

Cup holder, Umbrella holder (1 5/8" diameter) umbrella not included

Textured surface on steps and platforms Some assembly required

They even float!

**LG 510
LIFEGUARD CHAIR**

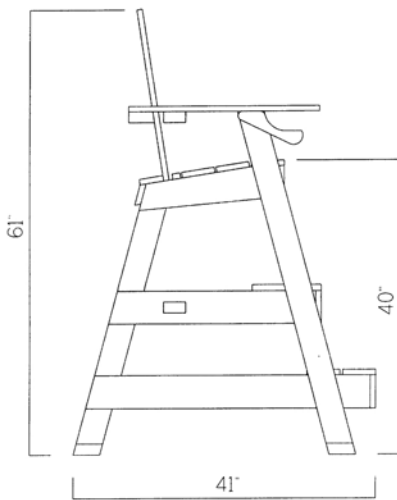

SIDE VIEW

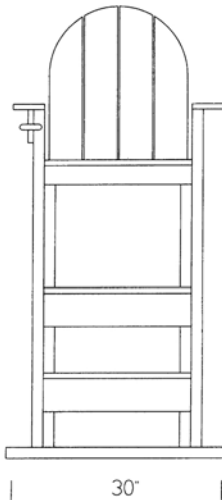

FRONT VIEW



DURAFIRM DIVE STANDS

Prices are Net - Add Freight from Sparks, Nevada



DuraFirm dive stands are the result of design engineering focused on stability, low noise level, safety and ease of installation on new or existing decks. All structural members are heavy aluminum castings. DuraFirm fulcrum & anchor units were chosen for all Olympics since Mexico 1968, including Atlanta.

		ITEM NO.
One Meter DuraFirm Dive Stand with Single Rail on One Side	#70-231-403	G3094*
One Meter DuraFirm Dive Stand with Single Rails on Both Sides	#70-231-402	G3095*
One Meter DuraFirm Dive Stand with Double Rails on Both Sides	#70-231-400	G3096*
Three Meter DuraFirm Dive Stand with Double Rails on Both Sides	#70-231-300	G3097*
Set of Bronze Anchors (8) for New Deck	#70-231-900	G7102*

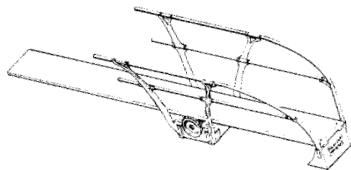

DURAFIRM SHORT STANDS

Designed for mounting on a concrete, steel or other field-fabricated diving platform. Short Stands have fulcrum units identical to the One & Three Meter Stands & similar guard rails & anchoring units.

Short Stand without Guard Rails	#70-231-524	G4150*
Short Stand with Double Rails on Both Sides	#70-231-520	G4165*

Prices are Net
F.O.B. Sparks, Nevada

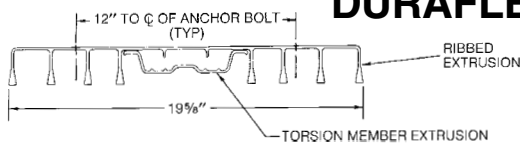

DURAFLEX DIVING BOARDS

14' DuraFlex Diving Board	G4000*
16' DuraFlex Diving Board	G4002*
16' DuraFlex Diving Board (Stocked)	G4003
16' Maxiflex B Diving Board	G4006*

*Non-Stock Item

Misc. Dive Stand Parts -

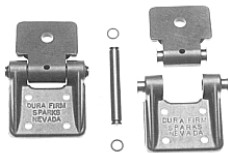

30" Vinyl Channel Set w/Cement	MP-112	G4010
Glue Kit Only for Vinyl Channel Sets	MP-114	G4011
Hinge Assembly w/Nuts & Bolts	C-202	G4025
S.S. Board Bolt 5/8" x 3-1/2" & Nut	SF-122	G4012
Brass Nut Only 5/8"	SF-137	G4015
5/8" x 5-1/2" Cad-Plated Carriage Bolt & Nut	SF-141	G4014
DuraFirm Grease Gun	PM-110	G4016
DuraFirm Mystik Grease - 3 oz. Tube	PM-111	G4017
Rail Clamp only	C-207	G4018
Bolt For S.S. Clamp 5/16" x 5/8"	SF-118	G4019
Slide Bar	518	G4020

Many more DuraFlex parts are available call us to check for parts!

PARAGON DIVE STANDS

One Meter Topflyte

Suitable for competition & larger commercial pools. Available w/flanged or plain pedestals & equipped w/geared adjustable fulcrum & rear swivel.



One Meter Topflyte Dive Stand
(with Plain Pedestal)

ITEM NO.
H1152*

One Meter Sportflyte

An economy model designed for wood diving boards & recreational pools only. (Not suitable for competition). Fulcrum is adjustable (but not geared). Flanged or plain pedestal available.

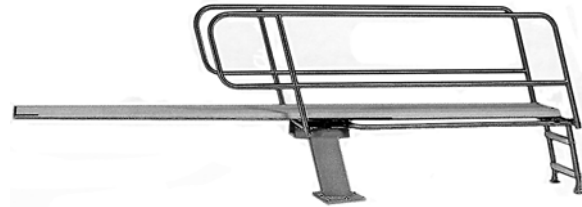

One Meter Sportflyte Stand - 14' Board
One Meter Sportflyte Stand - 16' Board

H1196*
H1199*

(*Non-Stock Item)
F.O.B. Mfg. Plant

S.R. SMITH CO. DIVE STANDS

S.R. Smith Inc.



Econoline 1 meter Stand

Fabricated entirely of steel. Primed & ready for paint, for 12' or 14' board.



	ITEM NO.
One Meter Econoline Stand for 12' Board E-CAT-1M-100	G3306*
One Meter Econoline Stand for 14' Board E-CAT-1M-101	G3308
Handrails for Econoline Diving Stand 25-106 w/Mounting Kit	G3031
Fulcrum Bar Assembly w/Bumper (E-Cat & DLS)	G3029

Deck Level Stand - 1/2 & 2/3 Meter

All welded construction for 8' to 12' dive board.

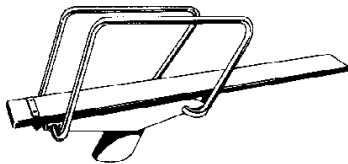

DECK LEVEL DIVING STAND

1/2 Meter Deck Level Dive Stand (DLS-100) for 8' or 10' Dive Board	G3032
2/3 Meter Deck Level Dive Stand (DLS-101) for 10' or 12' Dive Board	G3033*
Hand Rails for DLS-100 Deck Level Dive Stand (25-104) _{w/H.W. Kit}	G3034
Hand Rails for DLS-101 Deck Level Dive Stand (25-106) _{w/H.W. Kit}	G3031

Steel Meter Diving Stand

Three deluxe models completely prefinished with baked-on white enamel paint. Jig mounted & pre-drilled for handrails.

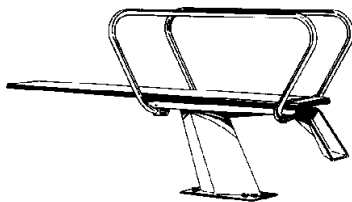

STEEL METER DIVING STAND

1/2 Meter Steel Dive Stand for 8' Board	G3208
1/2 Meter Steel Dive Stand for 10' Board	G3210
3/4 Meter Steel Dive Stand for 10' Board	G3310
3/4 Meter Steel Dive Stand for 12' Board	G3071
1 Meter Steel Dive Stand for 10' Board	G3069
1 Meter Steel Dive Stand for 12' Board	G3073
S.S. Handrail for 8' Board 71-209-550 w/Hardware	G3408
S.S. Handrail for 10' Board 71-209-551 w/Hardware	G3410
S.S. Handrail for 12' Board 71-209-552 w/Hardware	G3074
Jig Only for All Steel Meter Stands	G3078
Black Rubber Fulcrum Kit for All Steel Meter Stands	G3024
Bolt Kit for 3/4 & 1 Meter Dive Stands	G3079
SR Smith Hardware Kit for Handrail 71-209-561	G3076

INSTITUTIONAL LIFEGUARD STAND

S.R. Smith Inc.

*Includes fiberglass seat w/stainless steel seat swivel support & umbrella holder.
Designed to simplify installation. Order anchor sockets & escutcheons separately.*



H1208

S.R. Smith Institutional Lifeguard Stand	ILGC-205	ITEM NO. H1190
<i>w/4 stainless steel legs</i>		
Replacement Seat Only		H1205
Replacement Seat w/Swivel		H1203
Swivel Only for Seat Bottom		H1208
Chair w/Umbrella Support Stand (13-109)		H1209
10" Fulcrum Cover		H1602
Footboard for ILGC-205 Stand		H1204



INTERFAB LIFEGUARD STAND W/4 LEGS

Interfab Lifeguard Stand w/4 Stainless Steel Legs	H1191*
<i>& powder coated rails</i>	

*Non-Stock Item

SWAN CANTILEVER LIFEGUARD STAND

Supported by column slanted 15 degrees toward the pool. Footboard & chair are bolted to the support column. All Steel parts furnished w/one coat of primer.

Swan Cantilever Lifeguard Stand	CAT-LG-100	H1180
Footboard for Lifeguard Stand	8-602	H1217
Replacement Fiberglass Chair Only	<i>(New Style)</i>	H1216
Chair/Umbrella Support Assy	<i>(Old Style)</i>	H1219+
*Replacement Chair w/Swivel	<i>(New Style)</i>	H1215
*15" Seat/Support/Umbrella Holder	<i>(New Style)</i>	H1213
*Both needed to replace existing chairs		

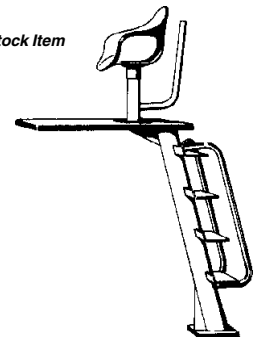

+Limited Stock

PARAGON PARAFLYTE CLUB

A single anchor at base supports the entire chair. The vertical access ladder requires less deck space & does not need separate anchors. Improved design.

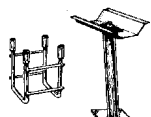

H1223

Paraflyte Club Lifeguard Stand w/S.S. Pedestal	21001	H1198
Replacement Seat Only		H1224
Swivel Chair Seat Support		H1223
Anchor Assembly for Chair		H1231
Footboard for Lifeguard Stand		H1228
Umbrella Holder		H1184
Umbrella Guide Ring		H1244



PARAFLYTE LADDER AT REAR

Ladder at rear w/flared guard rails provides easy access to the platform. Horizontal rails provide protection & serve as arm rests. Anchors & escutcheons included.

Paraflyte Lifeguard Stand w/Ladder at Rear	20002	H1210*
---	-------	--------

OSHA STYLE LIFEGUARD CHAIR

Guard rails are 42" above the platform & extend to the front of the platforms. Furnished w/all anchors & escutcheon plates. Complies w/OSHA regulations

Paraflyte OSHA Lifeguard chair	20004	H1192*
---------------------------------------	-------	--------



*Non-Stock Item
NET PRICE
- Add Freight

ASTRAL PORTABLE LIFEGUARD CHAIR



Chairframe is constructed from 1.7" diameter electropolished S.S. Steps & platform are injection molded plastic. Seat is form fitting & swivel mounted. S.S. life hook & umbrella support are provided.

Astral Portable Lifeguard Chair

H1182



PARAGON PORTABLE LIFEGUARD CHAIR



Weighing a mere 70 Lbs., this chair can be easily lifted by one person. Sloping front ladder allows easy access to molded contour seat. Angled legs give extra stability. Seat is six feet above deck (4-step unit). Not suitable for diving.

2-Step Paragon Portable Lifeguard Chair

G8056

3-Step Paragon Portable Lifeguard Chair

G8057*

4-Step Paragon Portable Lifeguard Chair

G8058*

Optional Portable Wheel Kit #20407

H1177

for new chairs or retrofitting old ones

Wheels for Moveable Guard Chair #20720

H1240

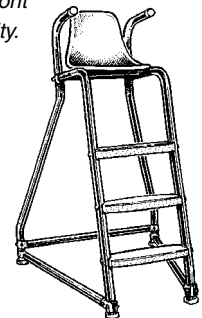

PORTABLE LIFEGUARD CHAIR

S.R. Smith Inc.

Designed to increase durability, improve aesthetics & reduce potential for damage during shipping. Includes fiberglass seat with new S.S. seat support & umbrella holder. 150 Lbs.

Portable Lifeguard Chair - PLS-204

H1193

Wheel for PLS-204 Chair

H1600

S R Smith F-100C 10" Fulcrum Cover

H1602



OBSERVATION PLATFORM



Ideal for use at kiddie pools & lazy rivers where high visibility is not required. Chair swivels 360 degree for full range of visibility & turning. Is open to exit from either side.

Short Chair Lookout Platform

G8050

(Seat is 34" above deck)

Mid Chair Lookout Platform

G8052

(Seat is 58" above deck)



**Non Stock Item*

Replacement Seats & Footboards

Repl. Chair (Frost/Swan) H1205

Swivel for Chair (Frost/Swan) H1208

Repl. Chair Only (Paragon) H1224

Repl. Chair Only (Paddock) H1251

Adapter for Chair (Paddock) H1255

Life Guard Arm Chair H1216
(SR Smith 8-610 White)

Footboard (SR Smith 8-705) H1204

Footboard (SR Smith 8-720) H1201

*For Repl. Seat (Seablue) order H1213 and H1203

Footboard (Swimquip 2823-15) H1206

Footboard (Swimquip 2800-4) H1245

Footboard (Swimquip 2825-33) H1207

Footboard (Seablue) H1226

Footboard (Paddock Large) H1222

Footboard (Paragon Wood) H1228

Footboard (Swan 8-602) H1217

Hook for Ring Buoy (Swan) H1202

Umbrella Holder (Paragon) H1184

Umbrella Ring Guide (Paragon) H1244

Umbrella - Blue & White H1195

Split Tee H1310



AQUA-CREEK Pro-Pool Lift

ADA compliant battery powered lift provides handicap access for aquatic therapy and water recreation. Features compact design, rechargeable 24 volt battery with charger, stainless steel construction, UV resistant powder coat finish, and submergible controller. Lift rated for 400 lbs and may be used with a permanent anchor or optional portable kit allowing flexible placement. Chair arms and footrest flip up to minimize footprint for storage.

Pro-Pool Lift H1260

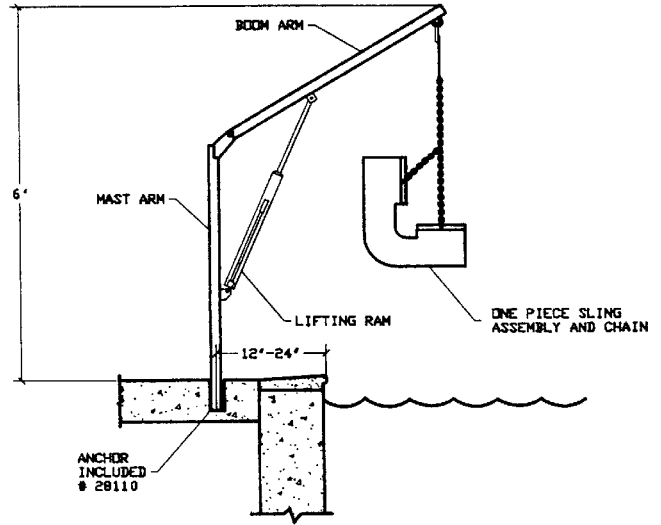

AQUA-CREEK EZ LIFT

Hydraulic powered pool lift for the handicapped. Economy priced & designed specifically for swimming pool use. Equipped with a dacron sling. Pool lift has maximum lift capacity of 400 lbs. & can be raised 62" up and down. Can be removed from flush mounted steel deck socket. Optional above deck socket available.

Aqua-Creek Pool Lift H1200
 Additional Anchor Socket H1194

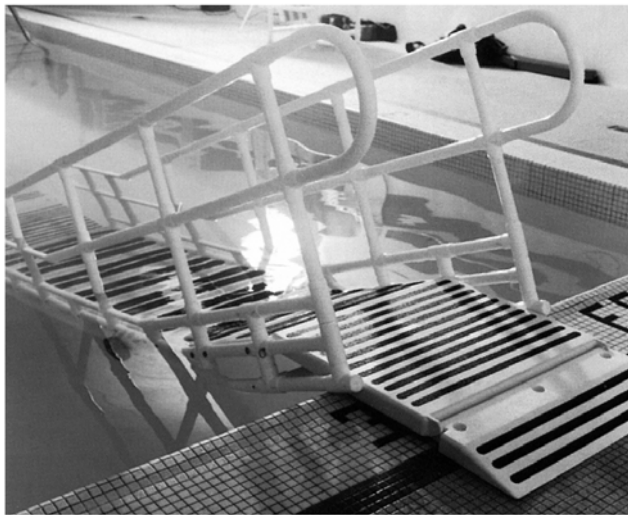

AQUA TREK RAMP

A removable ramp that allows people of all ages access to pool. Made of non-corrosive metal skeleton encased in PVC, the AQ-9000 is both lightweight & durable. It is rated for 600 lbs. & features 30" treads that are able to accomodate wheelchairs. Ramp is built on wheels & easily removable. Price includes shipping.

AquaTrek Ramp H1315*

*Non-Stock Item



SR Smith Inc.



SR SMITH HANDY LIFT

A manual handicap access system designed for commercial or residential pool facilities. Features heavy duty stainless steel design w/full 360 degree rotation, 62" lifting/lowering range with a 400 Lb. rated load. Comes complete with seat assembly & anchor system. 3-Year Warranty.

Handy Lift Access System H1250
 Complete w/Anchor

*Non-Stock Item



(Other Sizes Available - Call for Price)



NSF APPROVED

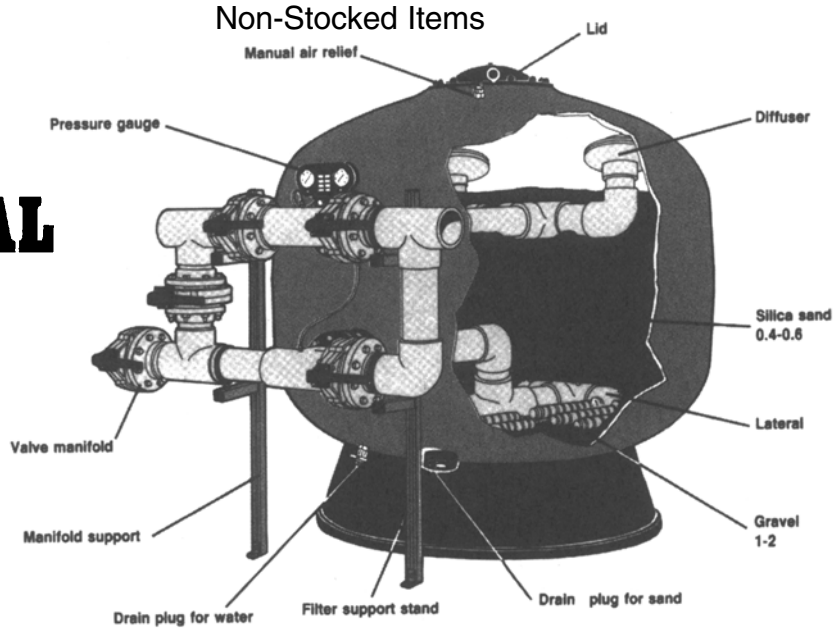

COMMERCIAL HI-RATE POLYESTER SAND FILTERS

Constructed of polyester & fiberglass filament winding. Tank includes gauge panel, air relief & drain valves.

Astral 63" Commercial Sand Filter Tank Only - 6" Flange	#06684	ITEM NO. H9500*
Flow Rate 432 GPM @ 20 GPM per Sq. Ft.		
Filter Media: All Sand (7,055 Lbs.) or Sand (5,405 Lbs.) & Gravel (1,650 Lbs.)		
Astral 71" Commercial Sand Filter Tank Only - 6" Flange	#06633	H9507*
Flow Rate: 546 GPM @ 20 GPM per Sq. Ft.		
Filter Media: All Sand (8,490 Lbs.) or Sand (6,840 Lbs.) & Gravel (1,650 Lbs.)		
Astral 79" Commercial Sand Filter Tank Only - 6" Flange	#06634	H9506*
Flow Rate: 676 GPM @ 20 GPM per Sq. Ft.		
Filter Media: All Sand (10,910 Lbs.) or Sand (8,375 Lbs.) & Gravel (2,535 Lbs.)		

SPACE SAVER POLYESTER SAND FILTERS

Astral 42" Semi-Commercial Sand Filter - 2-1/2" Bulkhead	H9518*
Flow Rate: 186 GPM	
Filter Media: All Sand (1,620 Lbs.)	
Astral 47" Semi-Commercial Sand Filter - 3" Flange	H9520*
Flow Rate: 244 GPM	
Filter Media: All Sand (2,450 Lbs.)	

Valve Manifold Support & Parts

2-1/2" Multiport Valve Kit	#08726	H9521
6" Valve Manifold Support	#00851	H9522*
Astral Filter Lid Only		H9524
Astral Filter Lid Gasket		H9523

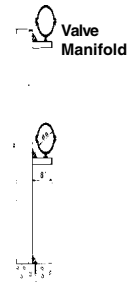
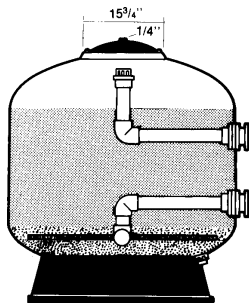

MIAMI TANK

*Non-Stocked
Items

Commercial Hi-Rate Sand Filters Single Tank Units with Face Piping

SFV 48"	ITEM NO. H1000*
SFV 54"	H1005*
SFV 60"	H1010*
SFV 72"	H1015*
SFV 78"	H1018*
SFV 84"	H1020*

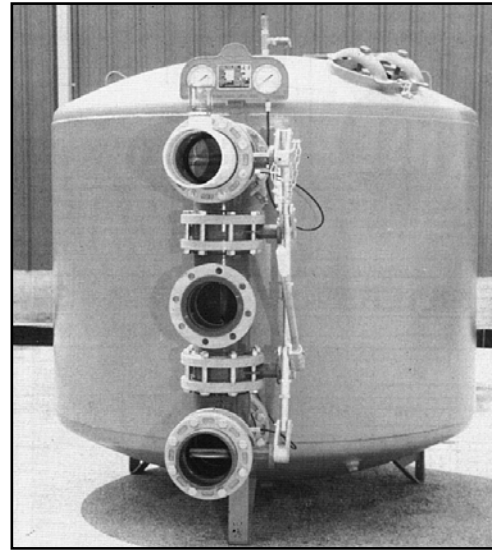

All SFV series systems include: internal distribution & collection system, aluminum gauge panel w/two 4-1/2" Gauges bronze sight glass, bronze manual & automatic air relief valve, side mounted face piping (available in cast iron or Schd 80 PVC) w/nylon coated wafer style butterfly valves, media dump port & winterizing drain. Units are priced with strap legs. Adjustable legs available, epoxy lining available at additional cost.

Single Lever Control for 4"	H1026*
Single Lever Control for 6"	H1027*

HI-RATE FILTERS - SFV SERIES - SINGLE TANK SYSTEMS										
PERFORMANCE SPECIFICATIONS										
MODEL NO.	TANK DIA.	SQ. FT. FILTER AREA	RATE AND CAPACITY				CU. FT. 1/8"-1/4" Gravel	CU. FT. # 20 SAND	APPROX. BED DEPTH	APPROX. SHIP WT. LBS.
			15 gpm	20 gpm	GP 6 hrs	GP 8 hrs				
SFV-36	36"	7.1	107	142	38,520	51,360	4	15	30"	770
SFV-42	42"	9.6	144	192	51,120	68,160	6	20	30"	920
SFV-48	48"	12.6	189	252	68,040	90,072	12	23	30"	1120
SFV-54	54"	15.9	238.5	318	90,720	120,960	16	26	30"	1290
SFV-60	60"	19.6	294	392	105,840	141,120	19	35	30"	1466
SFV-66	66"	23.7	355.5	474	127,980	170,640	24	41	30"	1640
SFV-72	72"	28.3	424.5	566	152,820	203,760	28	50	30"	1820
SFV-78	78"	33.2	498	664	179,280	239,040	33	58	30"	1970
SFV-84	84"	38.5	577.5	770	207,900	277,200	38	68	30"	2240
SFV-90	90"	44.2	663	884	238,680	318,240	44	77	30"	2550
SFV-96	96"	50.3	754.5	1,006	271,620	362,160	50	88	30"	2820
SFV-102	102"	56.7	850.5	1,134	306,180	408,240	57	99	30"	3300
SFV-108	108"	63.6	954	1,272	343,440	457,920	64	127	36"	3600
SFV-114	114"	70.9	1,036.5	1,418	382,860	510,480	72	160	36"	4420
SFV-120	120"	78.5	1,117.5	1,570	423,900	565,200	79	176	36"	5220
SFV-144	144"	113.1	1,696.5	2,262	610,740	814,320	103	280	36"	6800

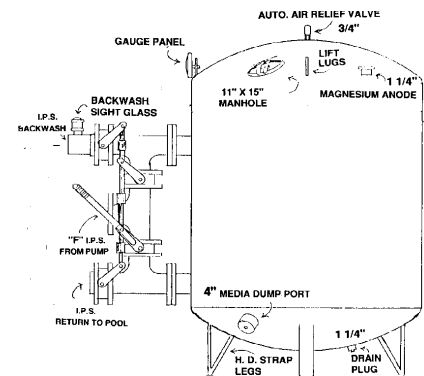

Replacement Components

Replacement Manhole Cover Assy	H1048
Gasket 11" x 15" for Manhole Cover	Z5016
Gauge Panel Complete	H1045
Pressure Gauge 4-1/2" Each	H7015
Bronze 1-1/2" Sightglass	H8060

PENTAIR "THS" SERIES



Two Head Smoothie Horizontal Sand Filter

Made of composite laminate design with smooth attractive finish. THS tanks feature large manway in front w/6" flanged connections & are designed to conserve space. NSF approved 50 psi rated tank w/flow rates up to 535 gallons per minute. Optional manual & automatic backwash systems available. 10 Year Tank Warranty.



MODEL NUMBER	TANK DIMENSIONS	FILTER AREA (SQ. FT.)	FLOW RATE (15 GPM/SQ. FT.)	TURNOVER RATE (8 HOURS)	TOTAL MEDIA (POUNDS)	ITEM NO.
THS3484	34" x 84"	19.0 Sq. Ft.	285 GPM	136,800	1950	H4130*
THS4272	42" x 72"	19.7 Sq. Ft.	295 GPM	141,600	2600	H4132*
THS4284	42" x 84"	23.2 Sq. Ft.	348 GPM	167,040	3000	H4134*
THS4296	42" x 96"	26.7 Sq. Ft.	400 GPM	192,000	3500	H4136*

(*Non Stock Items)



MIAMITANK

Non-Stocked Items

Horizontal Fully Automatic High Rate Sand Filters

Carbon steel tanks welded under ASME standards available in both automatic & manual operated systems. Each tank has oven baked Durasol PVC lining applied on both interior & exterior with a 15 year warranty. All connections & service fittings are Victolic Clamp type. No Threaded Fittings.

"HH" Series Automatic Systems

MODEL NO.	PIPE TANKS	SIZE
HH 3624-A	2	4"
HH 3626-A	2	6"
HH 3636-A	3	6"
HH 3638-A	3	8"
HH 3646-A	4	6"
HH 3648-A	4	8"
HH 3656-A	5	6"
HH 3658-A	5	8"

*Non-Stock - Special Order Only

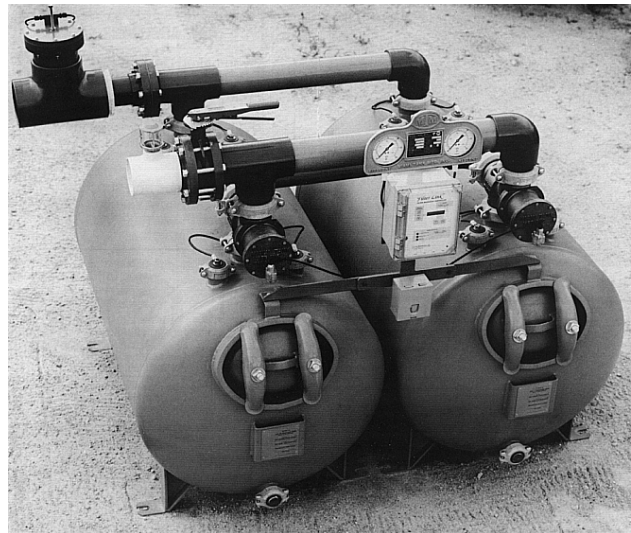

Automatic systems are controlled by a 4000 Series FilterLink Control Panel which governs the filtration & backwashing of single as well as multiple unit systems.

It assumes control of Circulation Pump, Heater, Chemical Controllers & Waste Line commanding all actions for a proper backwash cycle. LCD screen displays modes of operation including Flow Rate, Water Temperature, Pressure Differentials, Gallons Filtered, Waste Flow Detection & more.

SAND CAPACITY FOR EACH TANK - 1600 LBS.



COATES ELECTRIC POOL/SPA HEATERS

- * With Built-In Flow Switch
- * Incoloy Heating Elements
- * Close Differential Thermostat
- * Manual Reset Hi-Limit Switch

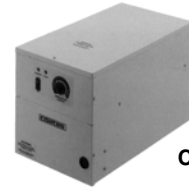

CE Model Heater



PHS/CPH Model Heaters

CPH 1-1/2" Connections
PHS 2" Connections

SIZING GUIDES:

Spa Water

$KW\ Required = \frac{Gallon\ Capacity \times 8.3\ (lbs./gal.) \times temperature\ rise\ in\ (F\ Degree)/Hour}{Divided\ by\ 3413^*}$

Pool Water

$KW\ Required = \frac{Pool\ Surface\ Area\ (Sq.\ Ft.) \times Temperature\ Differential\ (F\ Degree) \times 12}{Divided\ by\ 3413^*}$

*(1KW = 3,413 BTU/Hour)



COMPACT POOL/SPA HEATERS - CE Series

These pool & spa heaters feature a flow switch to prevent operations when there is no water flow. An all stainless steel tank for long life & corrosion resistance is also standard. 1-1/2" male connections.

240 Volt Single Phase

Model 12412CE	12 KW*	
Model 12415CE	15 KW	J3102*
Model 12418CE	18 KW	J3104*

208 Volt Three Phase

Model 32012CE	12 KW*	
Model 32015CE	15 KW	J3122*
Model 32018CE	18 KW	J3124*

240 Volt Three Phase

Model 32412CE	12 KW*	
Model 32415CE	15 KW	J3142*
Model 32418CE	18 KW	J3144*

480 Volt Three Phase

Model 34812CE	12 KW	J3160*
Model 34815CE	15 KW	J3162*
Model 34818CE	18 KW	J3164*

*SPECIAL ORDER ONLY
*F.O.B. Kent, WA.

POOL/COMMERCIAL SPA HEATERS - CPH & PHS Series

Medium capacity pool & spa heaters with built-in flow switch to prevent operation when there is no water flow. Allows operation at flow rates between 20 GPM & 80 GPM. All stainless steel for long life is standard.

240V Single Phase

Model 12424CP	24 KW	J3106*
Model 12430CP	30 KW	J3108*
Model 12436PH	36 KW	J3110*
Model 12445PHS	45 KW	J3112*
Model 12454PHS-4	54 KW	J3114*
Model 12457PHS-4	57 KW	J3116*

208 Volt Three Phase

Model 32024CPH	24 KW	J3126*
Model 32030CPH	30 KW	J3128*
Model 32036PHS	36 KW	J3130*
Model 32045PHS	45 KW	J3132*
Model 32054PHS-4	54 KW	J3134*
Model 32057PHS-4	57 KW	J3136*

*SPECIAL ORDER ONLY
*F.O.B. KENT, WA.

240 Volt Three Phase

Model 32424CPH	24 KW	J3146*
Model 32430CPH	30 KW	J3148*
Model 32436PHS	36 KW	J3150*
Model 32445PHS	45 KW	J3152*
Model 32454PHS-4	54 KW	J3154*
Model 32457PHS-4	57 KW	J3156*

480 Volt Three Phase

Model 34824CPH	24 KW	J3166*
Model 34830CPH	30 KW	J3168*
Model 34836PHS	36 KW	J3170*
Model 34845PHS	45 KW	J3172*
Model 34854PHS-4	54 KW	J3174*
Model 34857PHS-4	57 KW	J3176*

**RAYPAK
COMMERCIAL
GAS HEATERS**



NOTE - CSD-1 CODE (Control & Safety Devices) apply to Md., Va., Wash D.C. & other regional states.

- For Sizes: P-514 to P-824 Add \$250.50
- For Sizes: P-926 to P-1223 Add \$159.00
- For Sizes: P-1287 to P-2500 Add \$127.50
- For Sizes: P-3001 to P-4001 Add \$396.00

- (1) Select the desired swimming temperature of the pool water.
- (2) Determine the mean (average) temperature of the coldest month in which the pool will be used.
- (3) Subtract the mean temperature from the desired swimming temperature. The difference is the temperature rise.
- (4) Calculate the surface area of the pool in square feet.
- (5) Under the column headed by the temperature rise determined in Step 3, find the number close to, but not less than, the pool surface area from Step 4. On that line will be the correct indoor and outdoor heater.

Desired Temperature Rise in Degrees F.				DEALER NET PRICE F.O.B. WESTLAKE VILLAGE, CA. SPECIFY NATURAL OR PROPANE	
20	25	30	35		
Pool area in square feet				Indoor Model	Outdoor Model
1700	1360	1135	970	P-514 *	P-514 *
2090	1670	1390	1190	P-624 *	P-624 *
2420	1935	1610	1380	P-724 *	P-724 *
2750	2200	1830	1570	P-824 *	P-824 *
3085	2465	2055	1760	P-962 *	P-926 *
3610	2885	2405	2060	P-1125 *	P-1083 *
3925	3140	2615	2240	P-1223 *	P-1178 *
4250	3430	2860	2450	P-1336 *	P-1287 *
4710	3765	3140	2690	P-1468 *	P-1414 *
5230	4185	3485	2990	P-1631 *	P-1571 *
5860	4685	3905	3345	P-1826 *	P-1758 *
7000	5600	4665	4000	P-2100 *	-----
8330	6660	5550	4760	P-2500 *	-----
10000	8000	6665	5710	P-3001 *	-----
11665	9330	7775	6665	P-3500 *	-----
13330	10665	8885	7615	P-4001 *	-----

*Call for quotes

LAARS COMMERCIAL HEATERS

- *Greater Energy Efficiency 82%
- *Complete Control System
- * Built-in Flow Control Valve
- * One-Year/Five-Year Double Warranty
- * Includes CSD-1 Code
- * Includes In-field Start Up Fee

Mighty Therm AP Indoor Heaters

MODEL NO.	INPUT BTH/HR	OUTPUT BTU/HR	
500 I	500,000	405,000	*
715 I	715,000	579,000	*
850 I	850,000	689,000	*
1010 I	1,010,000	818,000	*
1200 I	1,200,000	972,000	*
1825 I	1,825,000	1,478,000	*

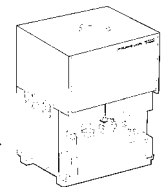

Mighty Therm AP Outdoor Heaters

* F.O.B. FACTORY

MODEL NO.	INPUT BTH/HR	OUTPUT BTU/HR	
500 E	500,000	410,000	*
715 E	715,000	579,000	*
850 E	850,000	697,000	*
1010E	1,010,100	828,000	*
1200 E	1,200,000	984,000	*
1825 E	1,825,000	1,497,000	*

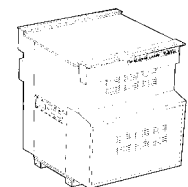

**EXTRA FOR BRONZE HEADERS MODELS 500 - 1825 *CALL FOR QUOTES

ITT MARLOW "3B" SERIES Self-Priming Centrifugal Pump

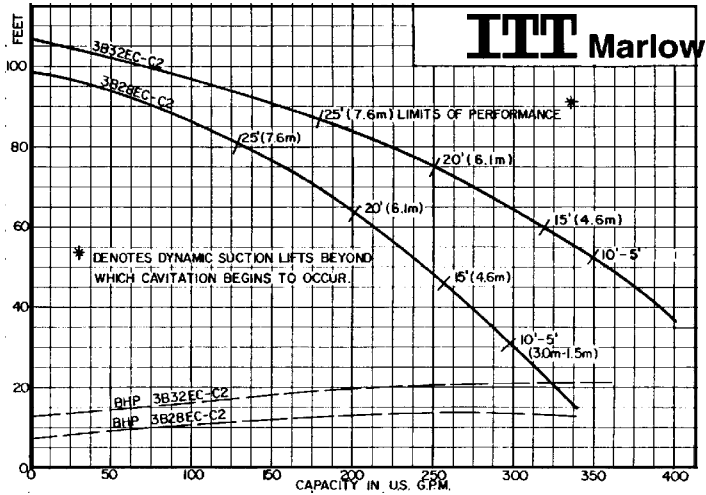
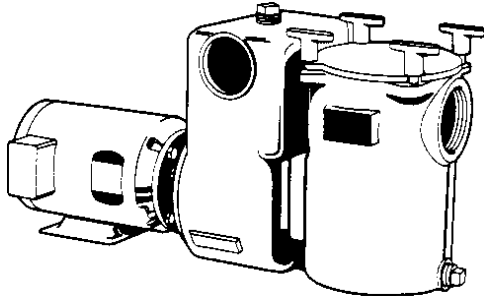

Rugged cast iron pool pump with large 7-1/2" diameter stainless steel strainer basket. The 3B series features a back pull-out design for simplified maintenance. The pump assembly can be removed without disturbing the suction and discharge piping.

HP	MODEL NO.	PHASE	VOLTAGE	TRAP SIZE	SUCTION SIZE	DISCHARGE SIZE	ITEM NO.
5 HP	3B28EC-C2	1-Phase	230V	8"	4"	3"	H1141
5 HP	3B28EC-C2	3-Phase	208-230/460V	8"	4"	3"	H1142
7-1/2 HP	3B32EC-C2	1-Phase	230V	8"	4"	3"	H1143
7-1/2HP	3B32EC-C2	3-Phase	208-230/460V	8"	4"	3"	H1144

Replacement Parts for "3B" Series

Strainer Cover, Cast Iron	K9216	Threaded Stub for Knob, 1/2"	K9258
Gasket for Strainer Cover	K9220	S.S. Strainer Basket	K9227
Hand Knob for Lid, 1/2"	K9221	Plastic Coated Basket	K7128

Replacement Parts for "2AF" Series

Strainer Cover Lid, Cast Iron	K9207	S.S. Strainer Basket	K9208
Gasket for Strainer Cover	K9226	Plastic Coated Basket	K7125
Plastic Hand Knob for Lid	K4900	8-Hole Paper Gasket	K9200

ITT MARLOW "4 SPC" SERIES PUMPS Self-Priming Centrifugal Pump

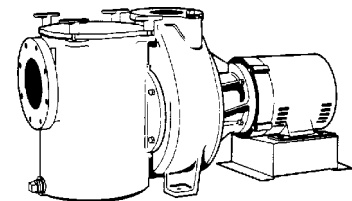

A Cast iron self-priming centrifugal pump with bronze impeller for commercial pools. Features extra large integral pump strainer (over 1100 cubic inches of volume). Maximum pumping capacity 800 gpm.

HP	MODEL NO.	SUCTION/DISCHARGE	VOLTAGE	PHASE	ITEM NO.
10 HP	(4 SPC10EC)	Pump 6" x 4"	1750 RPM 230V	1-Phase	H1115*
10 HP	(4 SPC10EC)	Pump 6" x 4"	1750 RPM 200-230/460V	3-Phase	H1116*
15 HP	(4 SPC15EC)	Pump 6" x 4"	1750 RPM 200-230/460V	3-Phase	H1117*
20 HP	(4 SPC20EC)	Pump 6" x 4"	1750 RPM 200-230/460V	3-Phase	H1118*

*Non-Stocked Item

ITT MARLOW "L" SERIES PUMP

Stock Line Centrifugal Pump with Bronze Impeller

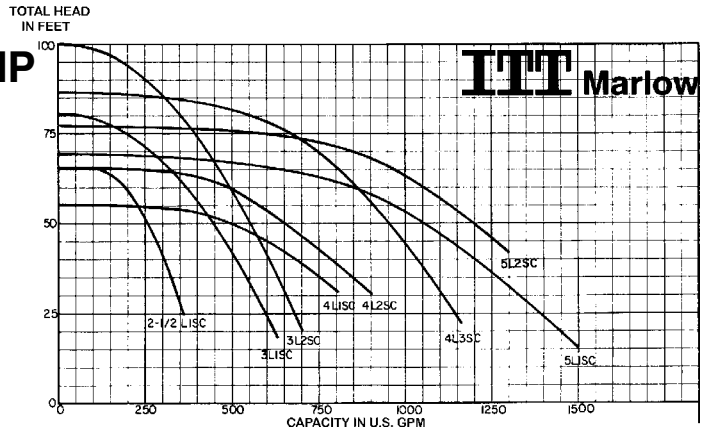
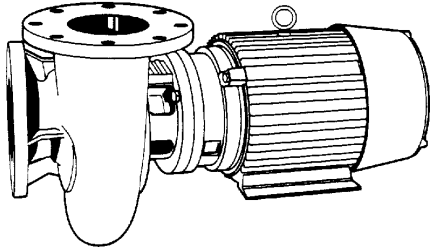

Rugged cast iron closed coupled centrifugal pump. Stock Line series pumps come equipped with an enclosed bronze impeller and feature a back pull-out design for simplified maintenance. The pump assembly can be removed without disturbing suction and discharge piping.

HP	MODEL NO.	SUCTION/DISCHARGE	VOLTAGE	PHASE	ITEM NO.
5 HP	(2-1/2L1SC)	"L" Pump 3" x 2-1/2"	1750 RPM 208/230V/460V	3-Phase	H1128
7-1/2 HP	(3L1SC)	"L" Pump 4" x 3"	1750 RPM 208-230/460V	3-Phase	H1132
7-1/2 HP	(4L1SC)	"L" Pump 5" x 4"	1750 RPM 230/460V	3-Phase	H1133
10 HP	(3L2SC)	"L" Pump 4" x 3"	1750 RPM 208-230/460V	3-Phase	H1129
10 HP	(4L2SC)	"L" Pump 5" x 4"	1750 RPM 230/460V	1-Phase	H1114
10 HP	(4L2SC)	"L" Pump 5" x 4"	1750 RPM 208-230/460V	3-Phase	H1134
15 HP	(4L3SC)	"L" Pump 5" x 4"	1750 RPM 230/460V	3-Phase	H1136
15 HP	(5L1SC)	"L" Pump 6" x 5"	1750 RPM 230/460V	3-Phase	H1137
20 HP	(5L2SC)	"L" Pump 6" x 5"	1750 RPM 230/460V	3-Phase	H1119

PENTAIR "EQ" SERIES PLASTIC PUMPS

w/Strainer

Complete Parts Breakdown on Pages 385-387



HP	MODEL NO.	SUCTION/DISCHARGE	VOLTAGE	PHASE	ITEM NO.
5 HP	EQ 500	6" x 4"	230V	1 Phase	H1070
5 HP	EQK 500	6" x 4"	208-230/460V	3 Phase	H1071
7-1/2 HP	EQ750	6" x 4"	230V	1 Phase	H1072
7-1/2 HP	EQK750	6" x 4"	208-230/460V	3 Phase	H1073
10 HP	EQK1000	6" x 4"	208-230/460V	3 Phase	H1074

Hair and Lint Strainer Complete with Lid, Gasket and Basket 6" x 4" #340013 K3735
 Strainer Basket Only #357184 K3733

PUREX CI L PUMP

3 HP	LHK-30	2.5" x 2"	208/220/440V	3 Phase	H1087+
------	--------	-----------	--------------	---------	--------

+Limited Stock

AQUA FLO / MARTIN (VAL-PAK) AC HIGH HEAD BRONZE PUMPS

3 HP	10030010	3" Suction - 2" Dis. 8" Trap	208-230V	1 Phase	K5501
3 HP	10030000	3" Suction - 2" Dis. 8" Trap	208-230/460V	3 Phase	K5511
5 HP	10050010	3" Suction - 2" Dis. 8" Trap	208-230V	1 Phase	K5500
5 HP	10050010	3" Suction - 2" Dis. 8" Trap	208-230/460V	3 Phase	K5514
7-1/2 HP	V40-539	3" Suction - 3" Dis.	230/460V	3 Ph	H1108



Pentair
Pool Products™



“C” SERIES Bronze Commercial Pump

Designed for commercial & other large swimming pools, fountains or water where high flow rates & continuous operation are desired. All bronze construction for strength & durability w/large stainless steel basket. Closed impeller for longer motor bearing life.

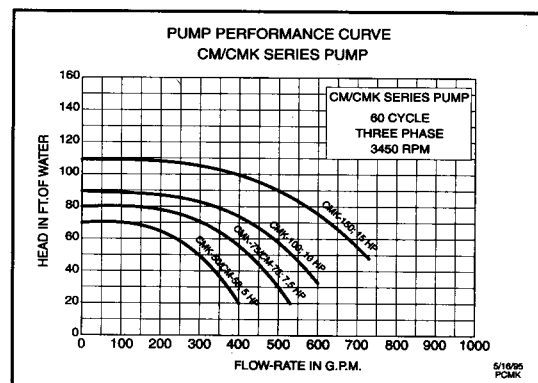
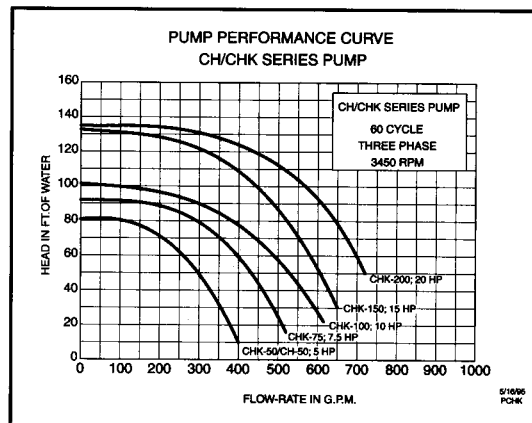

Medium Head

	MODEL NO.	IMPELLER	SUCTION/DISCHARGE	VOLTAGE	PHASE	ITEM NO.
	5 HP CM-50 Pump	Bronze	6" x 4"	230V Only	1-Phase	H1091
	7-1/2 HP CM-75 Pump	Bronze	6" x 4"	230V Only	1-Phase	H1092
	7-1/2 HP CM-75 Pump	Bronze	6" x 4"	208V Only	1-Phase	H1093
	5 HP CMK-50 Pump	Bronze	6" x 4"	208/220/440V	3-Phase	H1090
	7-1/2 HP CMK-75 Pump	Bronze	6" x 4"	208/220/440V	3-Phase	H1095
	10 HP CMK-100 Pump	Bronze	6" x 4"	208/220/440V	3-Phase	H1100
	15 HP CMK-150 Pump	Bronze	6" x 4"	208/220/440V	3-Phase	H1105

High Head

	5 HP CH-50 Pump	Bronze	6" x 4"	230V Only	1-Phase	H1088*
	5 HP CHK-50 Pump	Bronze	6" x 4"	208/220/440V	3-Phase	H1089*
	7-1/2 HP CHK-75 Pump	Bronze	6" x 4"	208/220/440V	3-Phase	H1094*
	10 HP CHK-100 Pump	Bronze	6" x 4"	208/220/440V	3-Phase	H1101*
	15 HP CHK-150 Pump	Bronze	6" x 4"	208/220/440V	3-Phase	H1106*
	20 HP CHK-200 Pump	Bronze	6" x 4"	208/220/440V	3-Phase	H1107*

C-SERIES REPLACEMENT MOTORS

	5 HP Purex/Triton C-Series	71366	230V	1 Phase	K9454
	5 HP Purex/Triton C-Series	71364	208/220/440V	3 Phase	K9455
	7-1/2 HP Purex/Triton C-Series	71365	208/220/440V	3 Phase	K9456
	10 HP Purex/Triton C-Series	71363	208/220/440V	3 Phase	K9457
	20 HP Purex/Triton C-Series	71362	208/220/440V	3 Phase	K9459*

*Non-Stock Item
FOB Mfg. Plant

STA-RITE COMMERCIAL PUMPS

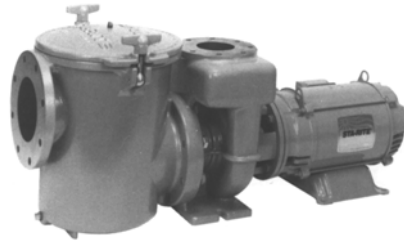

“CSP” SERIES

A high performance commercial pump especially designed for public swimming pools or spas where self-priming characteristics are desired. Features an oversized hair and lint strainer for large debris capacity. Cast iron construction with bronze impeller. Standard 4" x 6" flange connections.

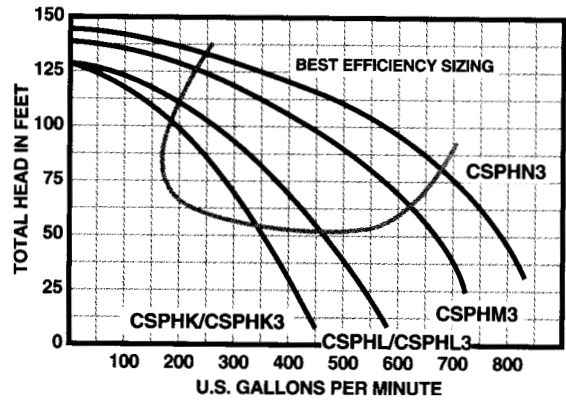

	MODEL NO.	CONNECTIONS	PHASE	VOLTAGE	ITEM NO.
7-1/2 HP	Sta-Rite Pump (CSPHK-142)	4" x 6"	1-Phase	230V	H1270*
7-1/2 HP	Sta-Rite Pump (CSPHK3-142)	4" x 6"	3-Phase	230/460V	H1272*
10 HP	Sta-Rite Pump (CSPHL-143)	4" x 6"	1-Phase	230/460V	H1274
10 HP	Sta-Rite Pump (CSPHL3-143)	4" x 6"	3-Phase	230/460V	H1276
15 HP	Sta-Rite Pump (CSPHM3-144)	4" x 6"	3-Phase	230/460V	H1278*
20 HP	Sta-Rite Pump (CSPHN3-145)	4" x 6"	3-Phase	230/460V	H1280*

Strainers Included



Package #184 Cast Iron Trap H1282
 Price Includes Trap
 Must Be Ordered Separately

STA-RITE "D" SERIES

Self-Priming Cast Iron Pumps

Especially suitable for commercial /public pools & spas where high performance & self-priming characteristics are desired. Self-Priming

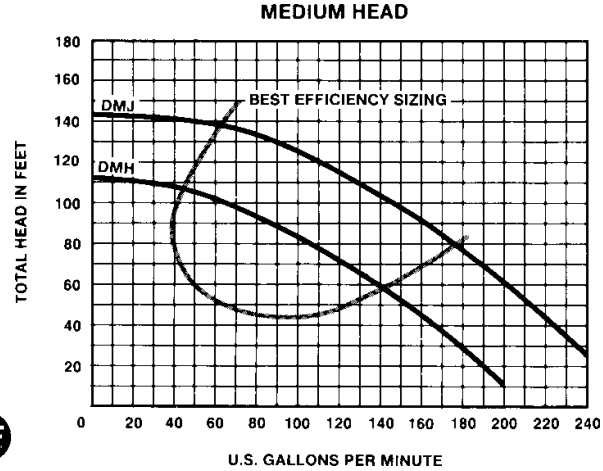
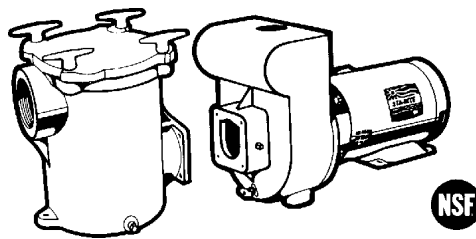

Medium Head

	PHASE	IMPELLER	TRAP	DISCHARGE	ITEM NO.	
DMH3*	3 HP	Sta-Rite Three	Cast Iron	None	2"	H1130
DMJ3*	5 HP	Sta-Rite Three	Cast Iron	None	2-1/2"	H1135
DMJ*	5 HP	Sta-Rite Single	Cast Iron	None	2-1/2"	H1125

* Trap Not Included in Price

STA-RITE PUMP TRAPS

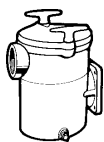

H1140

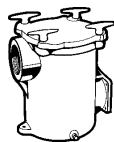

H1145



H1150

- #51 Sta-Rite 6" Cast Iron Trap 2" Suction H1140
- #98 Sta-Rite 8" Cast Iron Trap 3" Suction H1145
- #76 Sta-Rite Cast Iron Flange 3" Suction H1150

MARLOW HAIR & LINT STRAINERS

C10X & D10X Models



Low profile design permits installation without raising suction pipe & pump base above normal. Cast Iron design, equipped with super size heavy gauge stainless steel basket.

NOTE: MARLO NO LONGER MAKES HAIR & LINT STRAINERS REPLACE WITH MERMAID M-SERIES

		ITEM NO.
3" x 3" Flanged Hair & Lint Strainer	3C10X	H1156+
4" x 4" Flanged Hair & Lint Strainer	4C10X	H1157+
5" x 5" Flanged Hair & Lint Strainer	5D10X	N/A
6" x 5" Flanged Hair & Lint Strainer	6-5D10X	K9232+
6" x 6" Flanged Hair & Lint Strainer	6D10X	N/A
8" x 8" Flanged Hair & Lint Strainer	125BFC08	N/A

*Limited Stock



FIBERGLASS STRAINERS

For Marlow Replacement

"M" Series

Fiberglass reinforced plastic construction. Features quick opening latches, see thru lid with flanged connections.

3" x 3" Fiberglass Hair & Lint Strainer - Marlow Style	K6212*
4" x 4" Fiberglass Hair & Lint Strainer - Marlow Style	K6214
5" x 5" Fiberglass Hair & Lint Strainer - Marlow Style	K6216*
6" x 5" Fiberglass Hair & Lint Strainer - Marlow Style	K6217
6" x 6" Fiberglass Hair & Lint Strainer - Marlow Style	K6218*
8" x 8" Fiberglass Hair & Lint Strainer - Marlow Style	K6220*

*Non-Stock Item
Add Freight

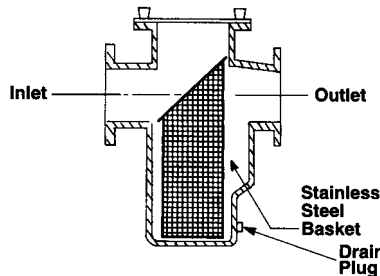

FIBERGLASS STRAINERS

For Hayward Replacement

"FO" Series

4" Fiberglass Hair and Lint Strainer w/ S.S. Basket	K6121*
6" Fiberglass Hair and Lint Strainer w/ S.S. Basket	K6122*
8" Fiberglass Hair and Lint Strainer w/ S.S. Basket	K6123*

*Non-Stock Item
Add Freight

Will not Corrode or Rust - Includes Transparent Lid

Replacement Parts for Mer-Made Fiberglass Hayward Replacement Strainers

	4"	6"	8"
SS Basket	K6500	K6501	K6502*
Lid	K6506	K6507	K6508*
Lid O Ring	K6509	K6510	K6511*

*Non-Stock Item
Add Freight

Lid Hand Knob K6512

*Non-Stock Item
Add Freight

Replacement Parts for All Strainers

	3"-4"	5"-8"
SS Basket	K6520	K6522
Lid	K6528	K6530
Lid O Ring	K6524	K6526

TRITON II SAND FILTERS
- Original Design



Original design, one-piece fiberglass reinforced tank with UV resistant surface finish. Full 10 Year Warranty



TR-40	18"	Triton II Filter(No Valve)	ITEM NO. H4000
TR-50	21"	Triton II Filter(No Valve)	H4002
TR-60	24"	Triton II Filter(No Valve)	H4005
TR-100	30"	Triton II Filter(No Valve)	H4010
TR-140	36"	Triton II Filter(No Valve)	H4015

Complete Parts Breakdown on Pages 362-363



TRITON C - COMMERCIAL RATED

Features multiple diverters for increased filtration rates in commercial applications up to 20 GPM/Sq. Ft. Full 2" Drain - 8" opening for easy access to sand bed.

TR-100C	30" Triton Filter(No Valve)	H4011
TR-140C	36" Triton Filter(No Valve)	H4016

T.RITON C-3 W/ 3" FLANGE CONNECTIONS

TR-100C-3	30" Triton Filter(No Valve)	H4012
TR-140C-3	36" Triton Filter(No Valve)	H4018



MODEL NO.	TANK DIA.	TURNOVER (8 HRS.) CAPACITY (GAL.)	FLOW RATE GPM RES.	FLOW RATE GPM PUBLIC	ALL SAND (LBS)	SAND & GRAVEL (LBS.)	(LBS.)
Triton II TR-40	19"	18,240	38	38	175	125	50
Triton II TR-50	21"	23,520	49	49	225	175	50
Triton II TR-60	24"	30,240	63	63	325	275	50
Triton II TR-100	30"	47,040	98	74	600	450	150
Triton II TR-140	36"	67,680	141	106	925	650	275
Triton C TR-100C	30"	47,040	98	98	600	450	150
Triton C TR-140C	36"	67,680	141	141	925	650	275
Triton C-3 TR-140C-3	36"	67,680	141	141	925	650	275

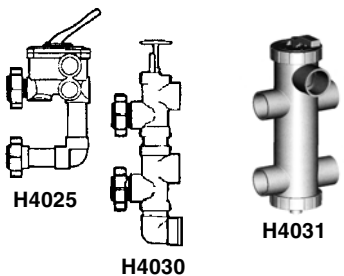

Backwash Valve Kits

1-1/2" Multiport Valve Kit	ITEM NO. H4020
2" Multiport Valve Kit	H4025
2" Push-Pull Valve Kit	H4030
2" Side Mount Full Flow Valve	H4031
2" Multiport Hi Flow Valve	H4034

Save up to 20% on Praher Brand Multiport Valve Kits! Just place a "P" after the item # on most multiport valves.

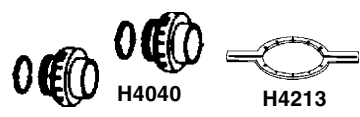

Accessories

1-1/2" & 2" Slip Adapter Kit	H4040
Aluminum Closure Wrench	H4213



TAGELUS DELUXE SAND FILTERS

with Top Mounted Multiport Valve

Complete
Parts
Breakdown
on Pages
358-361

One piece fiberglass reinforced tank with unequal strength & durability.
Tagelus Deluxe Filters feature a clamp type top-mounted multiport valve
& have a full 10 year tank warranty

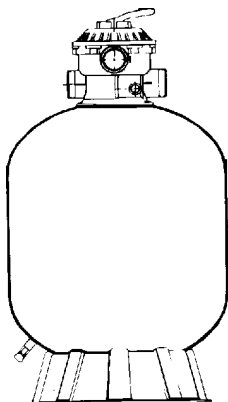

				ITEM NO.
SD-35	16"	Sand Dollar Filter	1-1/2" Valve	H4101
TA-40D	19"	Deluxe Sand Filter	1-1/2" Valve	H4105
TA-50D	21"	Deluxe Sand Filter	1-1/2" Valve	H4110
TA-60D	24"	Deluxe Sand Filter	1-1/2" Valve	H4115
SD-80	26"	Sand Dollar Filter	1-1/2" Valve	H4108
TA-100D	30"	Deluxe Sand Filter	2" Valve	H4118

Replacement Valves

1-1/2" Tagelus Valve - Clamp Style (Deluxe)	H4122
1-1/2" Tagelus Valve - V Threads (Old Style)	H4120
1-1/2" Tagelus Valve - Buttress Threads (After 1991)	H4121

MODEL NO.	DIAMETER	GPM	TURNOVER (8 HOURS) CAPACITY (GALS.)	SAND REQUIRED
SD-35	16"	35	16,800	100 lb.
TA-40D	19"	40	19,200	175 lb.
TA-50D	21"	50	24,000	225 lb.
TA-60D	24"	60	28,800	325 lb.
SD-80	26"	75	36,000	350 lb.
TA-100D	30"	100	48,000	600 lb.

Save 15 to 20% on
Praher Brand Valve
Kits! Just place a
"P" after the item
on most valves.

COMMON PARTS FOR TRITON & TAGELUS FILTERS

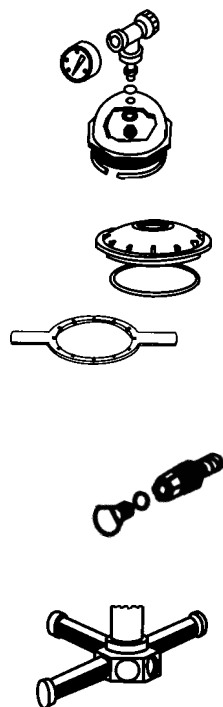

Dome 6" for Triton II Filters (V-Threads) <i>Pre-1992</i>	H4043
Dome 6" for Triton II Filters (Buttress Threads)	H4045
Dome 8-1/2" Triton Commercial Filters (<i>TR100C/140C</i>)	H4277
O-Ring for Triton II Dome - White	H4047
O-Ring for Triton Dome & Tagelus Valve (<i>TA30 thru TA60</i>)	H4044
O-Ring for Tagelus Deluxe Valve (<i>TA30D thru TA60D</i>)	H4344
Square Ring for Triton 8-1/2" Dome (<i>TR100C/TR140C</i>)	H4291
Wrench for 6" Dome <i>Plastic</i>	H4046
Wrench for 8-1/2" Dome <i>Plastic</i>	H4337
Pressure Gauge - Back Mount	H7010
Bleeder Valve Assy Complete (<i>Triton & Triton II</i>)	H4050
Bleeder Valve Assy - Manual (<i>TR100C/TR140C</i>)	H4242
Drain Assembly 3/4" (<i>1983-1996 Triton</i>)	H4311
Drain Assembly 1/2" - (<i>Pre-1983</i>)	H4070
1/4" Plug for Drain Assembly	H4312
Lateral 5-11/32" for Tagelus Filter (<i>TA30/35 & TA30D/35D</i>)	H4294
Lateral 6-11/16" for Tagelus/Triton Filter (<i>TR40/50/60, TA40/50/60</i>)	H4062
Lateral 9-1/8" for Tagelus/Triton Filter (<i>TR100 after '85, TR100C, TA100D</i>)	H4206
Lateral 12" for Triton Commercial Filter (<i>TR140, TR140C & TR140C3</i>)	H4068

HAYWARD PRO SERIES
Side-Mount Sand Filters

Molded of durable, corrosion-proof polymeric material, Pro Series filters are suitable for all types & sizes of in-ground pools & commercial spas.



Model Number	Effective Filtration Area	Design Flow Rate*	Turnover (In Gallons)	
			8 Hours	10 Hours
S-210S	2.20 ft. ²	44 GPM	21,120	26,400
S-244S	3.14 ft. ²	62 GPM	29,760	37,200
S-310S	4.91 ft. ²	98 GPM	47,040	58,800

*Based on 20 GPM/ft.² (maximum allowable NSF rating).



- S210S** Hayward 20" Polymeric Sand Filter w/1-1/2" Multiport Valve ITEM NO. H6083
- S244S** Hayward 24" Polymeric Sand Filter w/1-1/2" Multiport Valve H6068
- S310S** Hayward 30" Polymeric Sand Filter No Valve H6067
- 1-1/2" Vari-Flo 6-Way Valve H8016
- 2" Vari-Flo 6-Way Valve H8017

Complete Parts Breakdown on Pages 356-357

Save 15 to 20% on Praher Brand Valve Kits! Just place a "P" after the item # on most multiport valves.

HAYWARD PRO SERIES PLUS
Side-Mount Sand Filters

Model Number	Effective Filtration Area	Design Flow Rate*	Turnover (In Gallons)	
			8 Hours	10 Hours
S-311SXV	4.95 ft. ²	99 GPM	47,520	59,400
S-360SX	6.68 ft. ²	133 GPM	63,840	79,800



- S311SX** Hayward 31" Pro Series Plus Filter No Valve H8012
- S360SX** Hayward 36" Pro Series Plus Filter No Valve H8013
- 1-1/2" Vari-Flo 6-Way Valve H8016
- 2" Vari-Flo 6-Way Valve H8017
- Plumbing Adapter Kit H6122

Save 15 to 20% on Praher Brand Valve Kits! Just place a "P" after the item # on most multiport valves.

HAYWARD PRO SERIES
Top-Mount Sand Filters

Model Number	Effective Filtration Area	Design Flow Rate*	Turnover (In Gallons)	
			8 Hours	10 Hours
S-220T	2.64 ft. ²	52 GPM	24,960	31,200
S-244T	3.14 ft. ²	62 GPM	29,760	37,200
S-310T	4.91 ft. ²	98 GPM	47,040	58,800



- S180T** 18" Polymeric Sand Filter w/1-1/2" Valve H6033
- S210T** 20" Polymeric Sand Filter w/1-1/2" Valve H6066
- S220T** 22" Polymeric Sand Filter w/1-1/2" Valve H6034
- S244T** 24" Polymeric Sand Filter w/1-1/2" Valve H6036
- S270T** 27" Polymeric Sand Filter w/1-1/2" Valve H6038
- S310T2** 30" Polymeric Sand Filter w/2" Valve H6022
- 1-1/2" Vari-Flo XL Valve - Top Mount SP0714T H8000
- 2" Vari-Flo Valve - Top Mount SP071621 V4106
- O-Ring Kit For All of the Above RO321 H2532
- GMX600F Valve O-Ring Kit 152/225,S180/210/220/244T H8425

Complete Parts Breakdown on Page 355

Save 15 to 20% on Praher Brand Valve Kits! Just place a "P" after the item # on most multiport valves.



Laser

JACUZZI LASER SAND FILTER

Corrosion resistant, UV resistant, one-piece tank with 7-way dial valve. 12 year tank warranty.

ITEM NO. PRICE

16"	Laser Sand Filter (L160-7) with 7-Way Dial Valve	H9268
19"	Laser Sand Filter (L190-7) with 7-Way Dial Valve	H9270
22-1/2"	Laser Sand Filter (L225-7) with 7-Way Dial Valve	H9272
25"	Laser Sand Filter (L250-7) with 7-Way Dial Valve	H9274
	4-Position Replacement Dial Valve (DVK-4)	H9280
	6-Position Replacement Dial Valve (DVK-6)	H9282
	7-Position Replacement Dial Valve (DVK-7)	H9293

MODEL NO.	SQ. FT.	GPM	TURNOVER (8 HOURS) CAPACITY (GALS.)	SAND REQUIRED
Laser 16"	1.33	33.3	16,000	140
Laser 19"	1.87	46.7	22,400	200
Laser 22-1/2"	2.64	66.2	62,400	250
Laser 25"	3.30	82.5	39,600	350

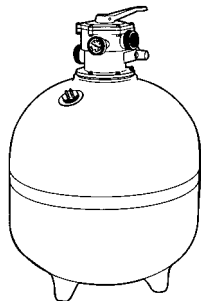

Sand Trap

JACUZZI SANDTRAP SAND FILTER

One piece roto-mold tank with dial valve - 12 year warranty

ST-27 Sand Trap 27" Sand Filter w/ No Valve	H9292+
	+ Limited Stock
1-1/2" Dial Valve for ST-24 Sand Trap Filter	H9296
1-1/2" Dial Valve for ST-27/33 Sand Trap Filter	H9297 (N/A)
2" Dial Valve for ST-27/33 Sand Trap Filter	H9295 (N/A)

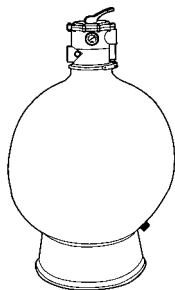

SandStorm

JACUZZI SANDSTORM SAND FILTER

One piece molded tank w/spherical design. Able to handle up to 96 GPM. Includes 7-way S.S. clamp style valve. 12 year tank warranty.

(TM26-7) Sandstorm 26" Filter w/ Valve	H9290
2" Top Mount Valve 7-Way Dial Valve (2DVK-C7)	H9283

Save 15 to 20% on Praher Brand Valve Kits! Just place a "P" after the item # on most valves.

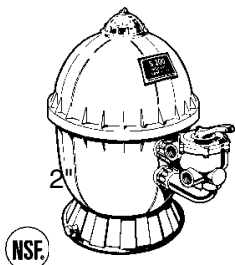

HAYWARD CYCLOCAC SAND FILTERS

Made of corrosion-proof ABS all-weather performance



S200 20" Cyclocac Sand Filter w/Valve		H6030
Dome Wrench Tool	S200KT	H6050
Valve Assembly	SP715X32	H6794

(See Pages 276-279 for Above Ground Pump & Filter Systems)

JACUZZI EARTHWORKS D.E. FILTERS



*Exclusive Ring-Lok Design - Modular Grid Assembly - Straight Vertical Grids
Built-In Selector Valve - 2" Ground Level Plumbing, 5-Year Warranty*

Model No.	GPM	Sq. Ft.	6 Hrs.	8 Hrs.	D.E. Req'd
EW75	70	34	25,200	33,600	8 Scoops
EW100	90	45	32,400	43,200	10 Scoops
EW125	115	57.5	41,400	55,200	13 Scoops
EW150	140	70	50,400	67,200	15 Scoops



EarthWorks	EW75	D.E. Filter Top & Bottom	(75 GPM)	H9230
EarthWorks	EW125	D.E. Filter Top & Bottom	(125 GPM)	H9234
EarthWorks	EW150	D.E. Filter Top & Bottom	(150 GPM)	H9235*

Complete
Parts
Breakdown
on Pages
343-344

Grid Assemblies for Earthworks Filters

EW 75	Complete Manifold Grid Assembly - Replacement	H8156
EW 100	Complete Manifold Grid Assembly - Replacement	H8157
EW 125	Complete Manifold Grid Assembly - Replacement	H8158
EW 150	Complete Manifold Grid Assembly - Replacement	H8159

JANDY DEL SERIES D.E. FILTERS

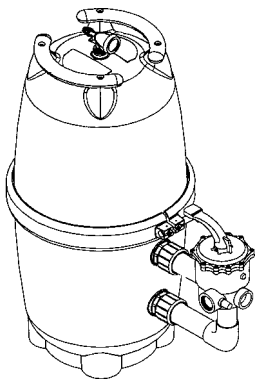

*Utilizes design of straight, vertical grids for maximum filtration & thorough
backwashing. DEL tanks include helpful handles & heavy duty clamp.
Features modular grid system that is easily removed as single piece.*



DEL48 Jandy D.E. Filter	(48 Sq. Ft.) - No Valve	H2024
DEL60 Jandy D.E. Filter	(60 Sq. Ft.) - No Valve	H2026

2" Slide Valve for DEL48 & DEL60 Filters Only	H2305
2" Side Mount Multiport Valve Kit	H2307
2" Multiport Valve Unions (Set of 3) #R0443800	V4485

Complete
Parts
Breakdown
on Page 345



HAYWARD PRO-GRID VERTICAL GRID D.E. FILTER

Constructed in high-strength PermaGlass XL with 2" full-flow internal piping & plumbing. Meets demands of toughest applications & environmental conditions, including in-floor cleaning systems.

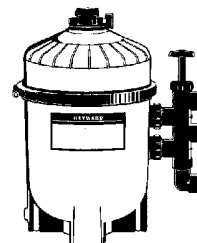

DE7220 w/Multiport



Performance Data – Filter

Model Number	Effective Filtration Area	Design Flow Rate	Turnover (In Gallons)	
			8 Hours	10 Hours
DE2420	24 ft. ²	48 GPM	23,040	28,800
DE3620	36 ft. ²	72 GPM	34,560	43,200
DE4820	48 ft. ²	96 GPM	46,080	57,600
DE6020	60 ft. ²	120 GPM	57,600	72,000
DE7220	72 ft. ²	144 GPM	69,120	86,400

Complete Parts Breakdown on Pages 341-342

	ITEM NO.
24 Sq. Ft. Pro-Grid DE2420 Filter Only	No Valve H5990
36 Sq. Ft. Pro-Grid DE3620 Filter Only	No Valve H5992
48 Sq. Ft. Pro-Grid DE4820 Filter Only	No Valve H5994
60 Sq. Ft. Pro-Grid DE6020 Filter Only	No Valve H5996
72 Sq. Ft. Pro-Grid DE7220 Filter Only	No Valve H5998

VALVE ASSEMBLIES

1-1/2" NPT Vari Flo Valve Assembly	(SP-710XR50)	H6070
2" NPT Vari Flo Valve Assembly	(SP-715XR50)	H6071
2" Skt. Slide Valve Assembly	(SP-410X502S)	H6073

Save 15 to 20% on Praher Brand Valve Kits! Just place a "P" after the item # on most valves.

Grid Assemblies for Pro-Grid & Micro-Clear Filters

36 Sq. Ft. Complete Grid Assembly - Replacement	DEX3600DC	H6111
48 Sq. Ft. Complete Grid Assembly - Replacement	DEX4800DC	H6112
60 Sq. Ft. Complete Grid Assembly - Replacement	DEX6000DC	H6138
Complete Grid Assembly	DEX2420DC	H6136
Complete Grid Assembly	DEX7200DC	H6137

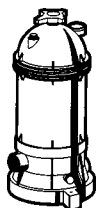

D.E. SEPARATION TANK

Injection-molded of Permaglass XL for all-weather performance

Corrosion Proof - 80 Sq. Ft. (C9002SEP) H6077

Ideal for Water Conservation & Savings
During Backwashing

HAYWARD PERFLEX D.E. FILTERS

All Perflex Filters Come w/ Check Valves, Pressure Guages & 1-1/2" Drain Valves



EC40AC

EC40AC Perflex Filter - Clamp Style Closure Design	H6078
EC50AC Perflex Filter - Clamp Style Closure Design	H6167
EC65A Perflex Filter w/Check Valve & Pressure Gauge	H6000
EC75A Perflex Filter w/Check Valve & Pressure Gauge	H6017
RG-700A Regenex D.E. Filter w/ Lock Ring Design	H6375+

+Limited Stock Item

System III Deluxe Base Less Pump EC65-BLP* H6001*

Also Fits Super, Super II & Maxi-Flo Pumps

(See Pages 276-279 for Above Ground Pump & Filter Systems)

FNS PLUS D.E. FILTERS
Reinforced Polypropylene Tank



A fiberglass reinforced polypropylene of advanced chemical resistant materials for superior strength & reliability. The top manifold design features the Service-Ease grid pack for convenient one-at-a-time grid servicing. Utilizes valves with 7-1/2" centerline bulkhead spacing. Almond Coloring.

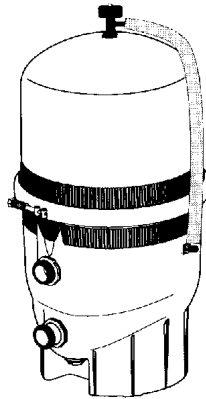

Model Number	Sq. Ft.	Design Flow Rate*				D.E. Precoat Required	Tank Height
		GPM	GPH	6 Hours	8 Hours		
FNSP24	24"	48	2,880	17,280	23,040	2.4 lbs.	37"
FNSP36	36"	72	4,320	25,920	34,560	3.6 lbs.	43"
FNSP48	48"	96	5,760	34,560	46,080	4.8 lbs.	49"
FNSP60	60"	120	7,200	43,200	57,600	6 lbs.	55"

Complete Parts Breakdown on Pages 346-347

* Flow rate is based on 2.0 GPM per sq. ft. of filter area. Actual system flow will depend on plumbing size and other system components.

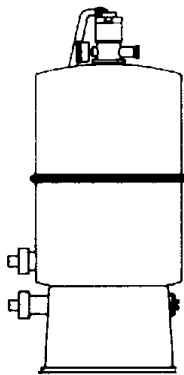

- | | |
|---|----------------|
| FNS Plus 24 Sq. Ft. D.E. Filter (No Valve) | ITEM NO. H3226 |
| FNS Plus 36 Sq. Ft. D.E. Filter (No Valve) | H3233 |
| FNS Plus 48 Sq. Ft. D.E. Filter (No Valve) | H3235 |
| FNS Plus 60 Sq. Ft. D.E. Filter (No Valve) | H3237 |
| FNS Plus 24 Sq. Ft. Complete Grid Assembly | H3700 |
| FNS Plus 36 Sq. Ft. Complete Grid Assembly | H3701 |
| FNS Plus 48 Sq. Ft. Complete Grid Assembly | H3702 |
| FNS Plus 60 Sq. Ft. Complete Grid Assembly | H3703 |

NAUTILUS PLUS NSP SERIES
Stainless Steel Tank

Tanks are made of 100% premium grade stainless steel to eliminate leaks & minimize corrosion. Grid design provides the most efficient DE filtration.

- | | |
|--|--------|
| NSP 24 Nautilus Plus DE Filter (No Valve) | H3000+ |
| NSP 36 Nautilus Plus DE Filter (No Valve) | H3005 |
| NSP 48 Nautilus Plus DE Filter (No Valve) | H3010 |
| NSP 60 Nautilus Plus DE Filter (No Valve) | H3015 |
| NSP 72 Nautilus Plus DE Filter (No Valve) | H3020 |

+Limited Stock

PENTAIR D.E. VALVES FOR FNS & FNS PLUS & NSP

For Pentair D.E. Filters with 7-1/2" Centerline Bulkhead Spacing



H4030



H3048

- | | |
|---|-------|
| 2" Push-Pull Valve Kit for Pentair Filters | H4030 |
| 1-1/2" Multiport Valve Kit for Pentair D.E. Filters | H3040 |
| 2" Multiport Valve Kit for Pentair D.E. Filters | H3045 |
| 2" Pac Fab 26-1142 Hi-Flow Valve & Plumbing Kit | H3048 |

Save 15 to 20% on Praher Brand Valve Kits! Just place a "P" after the item # on most valves.

(See Pages 120 - 121 for Replacement Valves)



Complete
Parts
Breakdown
on Pages
348-349



NAUTILUS FNS SERIES D.E. FILTERS

Fiberglass Reinforced Tank

PurexTriton FNS series fiberglass tanks are reinforced with unequaled strength & durability. Excellent for high pressure systems. Curved, modular grid assembly permits maximum filtration surface in minimum area.

Utilizes Valves with 7-1/2" Centerline bulkhead spacing.



FNS 24	Nautilus Fiberglass D.E. Filter (No Valve)
FNS 36	Nautilus Fiberglass D.E. Filter (No Valve)
FNS 48	Nautilus Fiberglass D.E. Filter (No Valve)
FNS 60	Nautilus Fiberglass D.E. Filter (No Valve)

ITEM NO.	H3001*
	H3006*
	H3011
	H3016

+Limited Stock
*Non-Stock Item

Grid Assemblies for Nautilus Filters

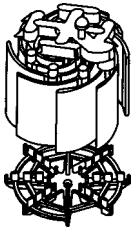

FNS-24	Complete Grid Assembly - Replacement	H4555
FNS-36	Complete Grid Assembly - Replacement	H4556
FNS-48	Complete Grid Assembly - Replacement	H4557
FNS-60	Complete Grid Assembly - Replacement	H3282
NS-24 / NSP-24	Complete Grid Assembly - Replacement	H3143
NS-36 / NSP-36	Complete Grid Assembly - Replacement	H3144
NS-48 / NSP-48	Complete Grid Assembly - Replacement	H3145
NS-60 / NSP-60	Complete Grid Assembly - Replacement	H3146
NS-72 / NSP-72	Complete Grid Assembly - Replacement	H3175

STAINLESS STEEL SEPARATION TANKS



#60 Separation Tank w/ 2" Connection	H3055
#80 Separation Tank w/ 2" Connection	H3056

REPLACEMENT D.E. GRIDS

Jacuzzi Rectangular Grids

		ELEMENT SIZE	ITEM NO.
EW75	42-2121-18-R	10" x 18"	H8124
EW75	42-2123-16-R	8-1/2" x 18"	H8125
EW75	42-2125-14-R	7" x 18"	H8126
EW100	42-2950-06-R	10" x 24"	H8127
EW100	42-2951-05-R	8-1/2" x 24"	H8128
EW100	42-2952-04-R	7" x 24"	H8129
EW125	42-2953-03-R	8-1/2" x 30"	H8130
EW125	42-2954-02-R	7" x 30"	H8131
EW125	42-2955-01-R	7" x 30"	H8132
EW150	42-2956-00-R	10" x 36"	H8133
EW150	42-2957-09-R	8-1/2" x 36"	H8134
EW150	42-2958-08-R	7" x 36"	H8135

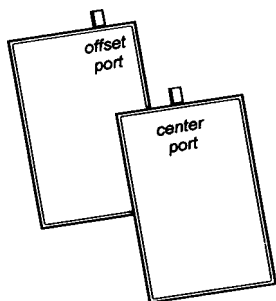
*Sta-Rite (Swimquip) Rectangular Grids*

Swimquip	23900-0031	5" x 18"	N5031
Swimquip	23900-0141	8-5/16" x 18"	N5073
Swimquip	23900-1173	9-11/16" x 18"	N5352
Swimquip	23900-0032	11" x 18"	N5032
Swimquip(Offset)	23900-0048	11" x 18"	N5070
Swimquip	23900-0052	13-3/4" x 18"	N5069
Swimquip	23900-0033	16-1/2" x 18"	N5033
Swimquip (Offset)	23900-0142	17-3/4" x 18"	N5010
Swimquip	23900-0144	19-1/4" x 18"	N5026
Swimquip (Offset)	23900-0145	19-1/4" x 18"	N5037
Swimquip	23900-0143	20-3/4" x 18"	N5036
Swimquip	23900-0034	22" x 18"	N5034

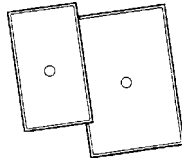
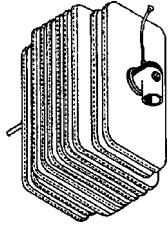

RECTANGULAR D.E. GRIDS

Anthony Apollo/Flowmaster

Apollo Grid - Small - 13-1/2" x 24"	ITEM NO. H3099
Apollo Grid - Large - 17-1/2" x 24"	H3100
Complete Grid Assy 38 Sq Ft. 1-1/2"	Z7028
Complete Grid Assy 52 Sq. Ft. 1-1/2"	Z7026
Complete Grid Assy 52 Sq. Ft. 2"	Z7025

(For complete list & breakdowns of Anthony Apollo & Flowmaster filters - See pages 291-293 of Parts Catalog)

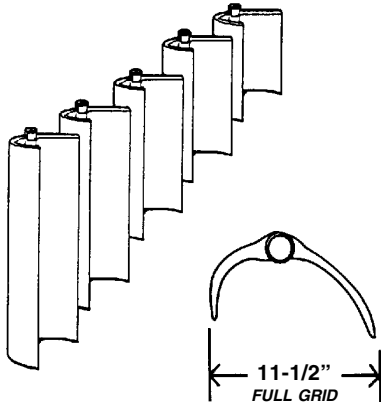

VERTICAL GRIDS - FULL

FILTER SIZE	<i>Purex</i>	ELEMENT SIZE	ITEM NO.
24 Sq. Ft.	07-4922 (S09300)	12" Full	H3680
36 Sq. Ft.	07-4923 (S08700)	18" Full	H3682
48 Sq. Ft.	07-4924 (S08800)	24" Full	H3684
60 Sq. Ft.	07-4925 (S08500)	30" Full	H3686
72 Sq. Ft.	07-4926 (S08600)	36" Full	H3688

VERTICAL GRIDS - FULL

FILTER SIZE	<i>American</i>	<i>Hayward</i>	<i>Pac-Fab</i>	<i>Jandy</i>	ELEMENT SIZE	ITEM NO.
24 Sq. Ft.	590011	DEX2400DA	19-2186		12" Large	H4400
36 Sq. Ft.	590018	DEX3600DA	19-2187		18" Large	H4401
48 Sq. Ft.	590024	DEX4800DA	19-2188	RO555000	24" Large	H4402
60 Sq. Ft.	590030	DEX6000DA	19-2189	RO359100	30" Large	H4403
72 Sq. Ft.	590036	DEX7200DA	19-5058		36" Large	H4404

VERTICAL GRIDS - PARTIAL

FILTER SIZE	<i>American</i>	<i>Hayward</i>	<i>Pac-Fab</i>	<i>Jandy</i>	ELEMENT SIZE	ITEM NO.
24 Sq. Ft.	590010	DEX2400DS	19-2328		12" Partial	H4405
36 Sq. Ft.	590017	DEX3600DS	19-2330		18" Partial	H4406
48 Sq. Ft.	590023	DEX4800DS	19-2332		24" Partial	H4407
60 Sq. Ft.	590029	DEX6000DS	19-2334	RO554900	30" Partial	H4408
72 Sq. Ft.	590035	DEX7200DS	19-5059	RO359200	36" Partial	H4409

REPLACEMENT D.E. GRIDS BY THE SET

(Complete Set per Box)

24 Sq. Ft.	(12") Complete Set (7 Full & 1 Partial) for American/Hayward/PacFab	H3094
36 Sq. Ft.	(18") Complete Set (7 Full & 1 Partial) for American/Hayward/PacFab	H3095
48 Sq. Ft.	(24") Complete Set (7 Full & 1 Partial) for American/Hayward/PacFab	H3096
60 Sq. Ft.	(30") Complete Set (7 Full & 1 Partial) for American/Hayward/PacFab	H3097
72 Sq. Ft.	(36") Complete Set (7 Full & 1 Partial) for American/Hayward/PacFab	H3098

Save 15 to 20% on Praher Brand Multiport Valve Kits! Just place a "P" after the item # on most valves.

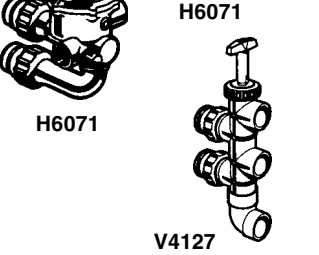
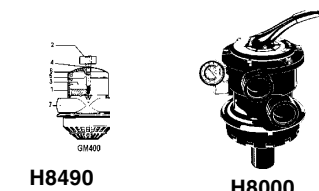
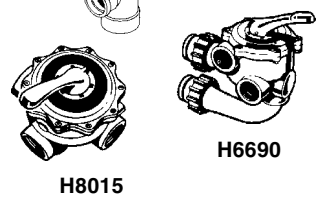
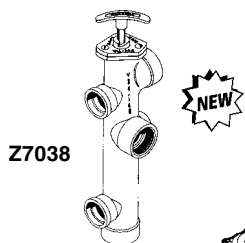

AMERICAN PRODUCTS VALVES

		ITEM NO.
1-1/2"	Multiport Valve (8-Pos) - Threaded <i>22" Top Mount Eclipse/Meteor</i>	50118200 H8852
1-1/2"	Multiport Valve (8-Pos) - Threaded <i>26" & 30" Top Mount Eclipse/Meteor</i>	50118300 H8853
2"	Multiport Valve (8-Pos) - Threaded <i>30" Top Mount Eclipse Filter</i>	50123100 H3221
1-1/2"	Multiport Valve Kit - Threaded Ports <i>w/Elbows for Side Mount Eclipse 8" Centerline</i>	50181211 H3241
2"	Multiport Valve Kit - Threaded Ports <i>w/Elbows for Side Mount Eclipse 8" Centerline</i>	50181311 H3242
2"	Push-Pull Valve ABS/Brass Piston <i>(8" Centerline)</i>	50290211 H3208
2"	Push-Pull Valve ABS w/Modified Pac-Fab Ftg. <i>(7-1/2" Centerline)</i>	H3209
1-1/2"	Multiport Valve Kit for DE Filters <i>(8" Centerline)</i>	50181212 H3238
2"	Multiport Valve Kit for DE Filters <i>(8" Centerline)</i>	50181312 H3239

+Limited Stock

ANTHONY SELECTOR VALVE

2"	Anthony Selector Valve - Threaded <i>Complete Assy - Brass</i>	V34-168 Z7038
----	---	---------------

HAYWARD VALVES - REPLACEMENT









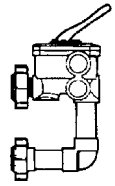
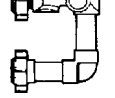
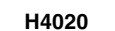

1-1/2"	Multiport Valve - All Ports Open	SP710XALL H8010
1-1/2"	Multiport Valve - Threaded <i>for Pac-Fab Sand Filters</i>	SP7122 H8002
1-1/2"	Multiport Valve Assy. w/Elbows <i>for Pro Series Sand Filter</i>	SP710X62 H8016
2"	Multiport Valve Assy. w/Elbows <i>for Pro Series Sand Filter</i>	SP715X62 H8017
1-1/2"	Multiport Valve Assy. <i>S-200 & 240 Sand Filter</i>	SPX0710X32 H6690
2"	Multiport Valve Assy. <i>S-240 Sand Filter</i>	SP715X32 H6794
2"	Multiport Valve - Side Mount	SP715XALL H8020
1-1/2"	Multiport 4-Way Valve	GM400 H8490
1-1/2"	Flange Mount Vari-Flo XL Valve	SP714T H8000
1-1/2"	Thread Mount Vari-Flo Valve <i>S-160T Style</i>	SP7121 H6409
1-1/2"	Multiport Valve Assy. w/Elbows - DE <i>(Micro-Clear & Pro-Grid Filters)</i>	SP710XR50 H6070
2"	Multiport Valve Assy. w/Elbows - DE <i>(Micro-Clear & Pro-Grid Filters)</i>	SP715XR50 H6071
2"	Selecta-Valve Assy. 4-Way <i>(Micro-Clear & Pro-Grid Filters)</i>	SP740DE V4127

BAKER-HYDRO VALVE

	2"	Baker-Hydro Push-Pull Valve - Complete Assy	30B0001	ITEM NO. H8801+*
---	----	---	---------	---------------------

H8801

PAC-FAB/PENTAIR VALVES

	1-1/2"	Tagelus Valve (V-type Threads) - Top Mount Before 1991	26-1124	H4120
	1-1/2"	Tagelus Valve (Buttress Threads) - Top Mount Before 1991	26-1130	H4121
	1-1/2"	Tagelus Valve (Clamp Type) - Top Mount TA30/40/50/60D	26-2506	H4122
	2"	Tagelus Valve (Clamp Type) - Top Mount TA100D Only	26-1185	H4343
	2"	Push-Pull Valve Kit	26-1165	H4030
	2"	Hi-Flow Valve with plumbing for Sand Filter	26-1050	H4034
	2"	Hi-Flow Valve with plumbing for D.E. Filter	26-1142	H3048
	2"	Push-Pull Valve D.E./Sand -71/2" on Center	26-3034	H3209
	1-1/2"	Multiport Valve Kit for Sand	26-1173	H4020
	2"	Multiport Valve Kit for Sand	26-1055	H4025
	1-1/2"	Multiport Valve Kit for DE	26-1177	H3040
	2"	Multiport Valve Kit for DE	26-1152	H3045
	2"	Side Mount Full Flow Valve - for Sand	26-3010	H4031

H4122

H4030

H4020

PRAHER VALVES (KITS & REPLACEMENTS)

	1-1/2"	Multiport Valve Kit for Sand	(Pac-Fab/Pentair filters)	H4020P
	2"	Multiport Valve Kit for Sand	(Pac-Fab/Pentair filters)	H4025P
	1-1/2"	Multiport Valve Kit for D.E.	(Pac-Fab/Pentair filters)	H3040P
	2"	Multiport Valve Kit for D.E.	(Pac-Fab/Pentair filters)	H3045P
	1-1/2"	Multiport Valve (Side Mount)	(all ports open FPT - Black)	H8010P
	2"	Multiport Valve (Side Mount)	(all ports open FPT - Black)	H8020P
	1-1/2"	Multiport Valve (Side Mount)	(all ports open FPT - White)	H8010PW
	2"	Multiport Valve (Side Mount)	(all ports open FPT - White)	H8020PW
	1-1/2"	Multiport Valve SM-10-AOS Slip	(all ports open)	H8041
	2"	Multiport Valve SM-20-AOS Slip	(all ports open)	H8042

H4031 & H3047

H4020P





H3045P

PARAGON PARAPORT

	1-1/2"	Paraport Valve- Threaded Ports	H8030+*
---	--------	--------------------------------	---------

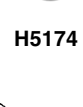
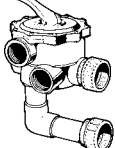
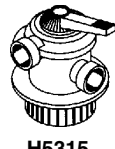
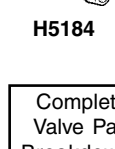
H8030

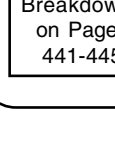
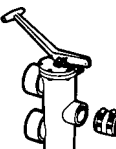
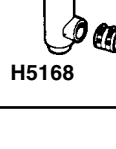
STA-RITE/SWIMQUIP VALVES

	2"	Push-Pull Valve w/Union Connection	WC212-134P	H5174
	2"	Push-Pull Valve ABS (No Unions)	14936-0000	H5168
	1-1/2"	Multiport Valve - Top Mount <i>for Waterford Series</i>	WC112-148	H5315
	1-1/2"	Multiport Valve w/Union Connection <i>Replaces WC212-143P</i>	18202-0150	H5184
	1-1/2"	Multiport Valve w/Union Connection	18201-0200	H5185
	2"	Multiport Valve w/Hose Connection <i>Replaces WC212-150PA</i>	18201-0200H	H5178
	2"	Slide Valve ABS <i>System 3 mod D.E.</i>	14935-0300	H5179
	1-1/2"x1-1/2"	Valve to Filter <i>Hose Connector Kit</i>	24750-0331	H5187
	1-1/2"x 2"	Valve to Filter <i>Hose Connector Kit</i>	24750-0624	H5188
	2" x 2"	Valve to Filter <i>Hose Connector Kit</i>	24750-0341	H5189
	2"	Waterway D.E. Mult Valve FPT	WVD001	H8001

H5174

H5315

H5184

H5168

Complete Valve Part Breakdowns on Pages 441-445

HAYWARD® STAR-CLEAR PLUS CARTRIDGE FILTERS

Constructed of New high-strength PermaGlass XL Material

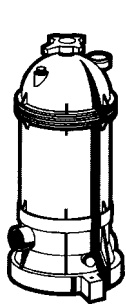

C900



C17502



			ITEM NO.
C751	Star-Clear Plus 75 Sq. Ft. Filter	1-1/2" FIP	H4970
C7512	Star-Clear Plus 75 Sq. Ft. Filter	2" FIP	H4972
C900	Star-Clear Plus 90 Sq. Ft. Filter	1-1/2" FIP	H4974
C9002	Star-Clear Plus 90 Sq. Ft. Filter	2" FIP	H4976
C1200	Star-Clear Plus 120 Sq. Ft. Filter	1-1/2" FIP	H4980
C12002S	Star-Clear Plus 120 Sq. Ft. Filter	2" SLIP	H4984
C17502	Star-Clear Plus 175 Sq. Ft. Filter	2" FIP	H4986
C17502S	Star-Clear Plus 175 Sq. Ft. Filter	2" SLIP	H4988
CX900K	PVC Socket Connector Set of 2	2" SLIP	H6942

Performance Data – Residential

Model Number	Effective Filtration Area	Design Flow Rate*	Turnover (In Gallons)	
			8 Hours	10 Hours
C751	75 ft ²	75 GPM	36,000	45,000
C900	90 ft ²	90 GPM	43,200	54,000
C1200	120 ft ²	120 GPM	57,600	72,000
C17502	175 ft ²	120 GPM	57,600	72,000

**One Gallon per Sq. Ft. Shown (Residential)
For Public Design Flow Rate - Base on .375 GPM/Sq.Ft.*

HAYWARD STAR-CLEAR FILTERS

Star-Clear Filters

	ITEM NO.
C250 Star-Clear 25 Sq. Ft. Cartridge Filter 1-1/2" FIP	H5010
C500 Star-Clear 50 Sq. Ft. Cartridge Filter 1-1/2" FIP	H5012
R222 Star-Clear O-Ring Kit RO-KIT 222	H2506

Micro Star-Clear In-Line filters

C225 Micro Star-Clear 25 Sq. Ft. In-Line Filter 1-1/2" FIP	H5003
---	-------

Micro Star-Clear System

C2251540LSS Micro Star-Clear Filter System Includes: C-225 Cartridge Filter (25 Sq. Ft.) Power-Flo Pump, Base, Hoses & 6' Cord	H6044
--	-------



C-225



C-250



C2251540LSS

JANDY CL SERIES CARTRIDGE FILTER

Corrosion-resistant injection-molded cartridge filter w/tank handles for easy installation & cleaning.

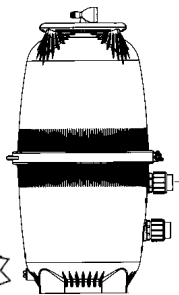

Jandy CL460 CL Series Cartridge Filter - 460 Sq. Ft.	H2014
Jandy CL580 CL Series Cartridge Filter - 580 Sq. Ft.	H2016
Jandy CL460 7" x 27", C-7468 - 115 Sq. Ft. (need 4)	H2096
Jandy CL580 (need 4) 7" x 33", C-7482 - 145 Sq. Ft.	H2098

(See Pages 276 - 279 for Above Ground Pump & Filter Systems)

HAYWARD®

SwimClear™

Complete Parts Break-down on Page 331

Large Capacity Cartridge Filters

PermaGlass XL filter tanks utilizing a cluster of four reusable cartridge elements. Heavy duty dirt holding capacity for extra long filter cycles, up to an entire season without cleaning.



C5025

- Hayward C2025 SwimClear Cartridge Filter
- Hayward C3025 SwimClear Cartridge Filter
- Hayward C4025 SwimClear Cartridge Filter
- Hayward C5025 SwimClear Cartridge Filter

- ITEM NO. H4991
- H4993
- H4995
- H4997

Performance Data – Residential/Public

Model Number	Effective Filtration Area	Design Flow Rate*†	Turnover (In Gallons)*	
			8 Hours	10 Hours
C2025	225 ft. ²	84 GPM	108,000	135,000
C3025	325 ft. ²	122 GPM	156,000	195,000
C4025	425 ft. ²	150 GPM	204,000	255,000
C5025	525 ft. ²	150 GPM	252,000	315,000



SWIMCLEAR REPLACEMENT CARTRIDGES

(4 Required)

- CX480XRE₂ For C2020/C2025 H5829
- CX580XRE₂ For C3020/C3025 H5831
- CX880XRE For C4020/C4025 H5833
- CX875RE For C4520 H5827
- CX1280XRE For C5020/C5025 H5030
- CX1380RE For C5520 H5835

*Non-Stock Item
- Add Freight

HAYWARD SWIMPURE

Mineral Purifying System for Hayward Star-Clear & SwimClear Cartridge Filters

A system designed to transform Hayward cartridge filters into pool water purifiers as well. Using Nature 2 science, Swimpure fits into the filter element and releases minerals into pool water making it clean and healthy. For in-ground pools up to 35,000 gallons.

- Lasts 6 full months
- Reduces chlorine usage up to 80%
- Installs easily in seconds
- Safe, natural & efficient

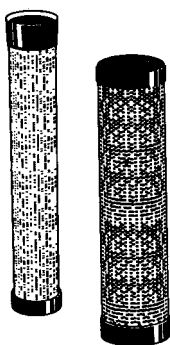

Debris in unfiltered pool water is trapped by Hayward cartridge filter element. Filtered water then passes through the Swimpure Natural Pool Purifying Delivery System - and re-enters the pool not only filtered - but purified as well.

MODEL NUMBER	SQ. FT.	FILTER SERIES	ITEM NO.
N2C900	90	C900/C751 (C800)	A3280+
N2C1200	120	C1200, C1750, C3000 C4000, C5000	A3282
N2C1750	175	C1750	A3284+
N2C2000	200	C2020	A3286+
N2C3000	300	C3020, C2000-5000	A3288
N2CW35	CART FLTR (REPL N2C900-1750)		A3290

+Limited Stock

JACUZZI TRI-CLOPS CARTRIDGE FILTERS



Complete Parts Break-down on Page 332

	ITEM NO.
TC330-MB Tri-Clops cartridge filter (330 Sq.Ft.)	H9239
(3 Needed) Replacement Cartridge - Each	H9427
TC440-MB Tri-Clops cartridge filter (440 Sq.Ft.)	H9255
(3 Needed) Replacement Cartridge - Each	H9429
TC550-MB Tri-Clops cartridge filter (55) Sq.Ft.)	H9258
(3 Needed) Replacement Cartridge - Each	H9431

TRI-CLOPS CARTRIDGE FILTERS "RETRO-FIT KITS"

TC-300 Element Internal Kit	H9415
TC-450 Element Internal Kit	H9417
TC-600 Element Internal Kit	H9419
TC O-Ring Kit RO-Kit 233 TriClops & Earthworks	H2512

JACUZZI SHERLOK CARTRIDGE FILTERS

Features easy Ring-Lok access to filter element for easy servicing. No tools required. Includes patented dirt catcher to prevent debris from falling into tank when element is removed. 5- year limited warranty



Sherlok 80	Cartridge Filter - 80 Sq. Ft. Element	H9217
Sherlok 120	Cartridge Filter -120 Sq. Ft. Element	H9218
Sherlok 160	Cartridge Filter -160 Sq. Ft. Element	H9222
Sherlok 200	Cartridge Filter -200 Sq. Ft. Element	H9223

JACUZZI CFR CARTRIDGE FILTERS

Exclusive Ring-Lok access - Patented sediment catcher Automatic air bleed. 5-year warranty



CFR-25	Cartridge Filter (In-Line) 1-1/2"	H9236
---------------	-----------------------------------	-------

+Limited Stock

HARMSCO HURRICANE FILTER

A single cartridge style filter engineered to more than double the performance of any comparable cartridge filter. Provides up to 5 times filtration cycles between servicing.



	ITEM NO.
HUR40TC	Harmsco Hurricane Filter 40 Sq. Ft. H2606*
HUR90TC	Harmsco Hurricane Filter 90 Sq. Ft. H2608*
HUR170TC	Harmsco Hurricane Filter 170 Sq. Ft. H2610*

SPECIAL ORDER ITEM

*Non-Stock Item - Add Freight



MODEL NO.	MAXIMUM FLOW RATE	(NSF) RESIDENTIAL MAX. POOL SIZE	RECOMMENDED MAX. POOL SIZED	FILTER AREA	HEIGHT CLEARANCE	PIPE SIZE INLET/OUTLET	PIPE SIZE DRAIN
HUR 40TC	40 GPM	14,400 Gal.	10,000 Gal.	40 Sq. Ft.	31"	2" NPT	1" NPT
HUR 90TC	90 GPM	32,400 Gal.	22,300 Gal.	90 Sq. Ft.	51"	2" NPT	1" NPT
HUR 170TC	170 GPM	61,200 Gal.	42,000 Gal.	170 Sq. Ft.	72"	2" NPT	1" NPT



Complete Parts Break-down on Page 335

CLEAN & CLEAR PLUS CARTRIDGE FILTERS Fiberglass Reinforced Polypropylene Tank



A corrosion resistant injection molded filter tank with strength & reliability.
Uses four easy to clean polyester cartridges. 10-year warranty



	ITEM NO.
Clean & Clear Plus 240 Sq. Ft. Cartridge Filter	H3450
Clean & Clear Plus 320 Sq. Ft. Cartridge Filter	H3452
Clean & Clear Plus 420 Sq. Ft. Cartridge Filter	H3454
Clean & Clear Plus 520 Sq. Ft. Cartridge Filter	H3456

Replacement Cartridges

Cartridge Element, 240 Sq. Ft.	(4-Required)	H3443
Cartridge Element, 320 Sq. Ft.	(4-Required)	H3444
Cartridge Element, 420 Sq. Ft.	(4-Required)	H3447
Cartridge Element, 520 Sq. Ft.	(4-Required)	H3449



RAINBOW IN-LINE FILTER

Rainbow RDC-25 In-Line Cartridge Filter - 1-1/2" FIP	H5480
Rainbow RTL-25 Top Load Cartridge Filter - 1" Slip	C1053
Chlorine/Bromine Dispenser for RTL Filters	H5098

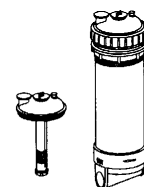

STA-RITE®

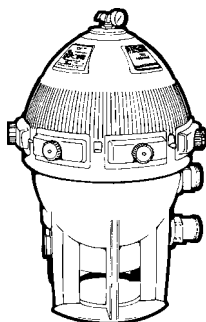

MODULAR MEDIA FILTER

SYSTEM:3™
FILTRATION

Ultra capacity filtration is achieved w/perfectly balanced flow and an integral manifold design.
Dirt loading capacities in excess of 50 times more than sand filters in equivalent sized tanks.
Design allows for rinse-in-place operation. No need for backwash valve or backwashing.

S7M120 Modular Media Filter (300 Sq. Ft.)	H5177
S8M150 Modular Media Filter (450 Sq. Ft.)	H5249
S8M500 Modular Media Filter (500 Sq. Ft.)	H5170

Replacement Modules

InnerReplacement Module for S7M120 (100 Sq. Ft.)	N5173
OuterReplacement Module for S7M120 (200 Sq. Ft.)	N5172
InnerReplacement Module for S8M150 (191 Sq. Ft.)	N5171
OuterReplacement Module for S8M150 (259 Sq. Ft.)	N5170
InnerReplacement Module for S8M500 (209 Sq. Ft.)	N5174
OuterReplacement Module for S8M500 (291 Sq. Ft.)	N5175



MODEL NO.	MAX. GPM	POOL SIZE FILTER AREA	8 HOUR RATE	CONNECTION
S7M120	100	300 Sq. Ft.	36,000-48,000 Gals.	2"
S8M150	125	450 Sq. Ft.	45,000-60,000 Gals.	2"

SWIMMING POOLS

		SQ. FT.	OUTSIDE DIAMETER	OVERALL LENGTH	INSIDE DIAMETER	PLEATCO NO.	DEALER UNICEL NO.	ITEM NO.
Advantage Electric								
ELE-50		50 Sq. Ft.	4-15/16"	17-3/8"	2-1/8"		C-4349	H5805
American Products (Pentair)								
566274	Quantum 175	43.7 Sq. Ft.	7"	11-13/16"	3"	PCM 44	C-7437	H5810
566278	Quantum 350	75 Sq. Ft.	7"	16-1/2"	3"	PCM 88	C-7474	H5279
566279	Quantum 520	125 Sq. Ft.	7"	26"	3"	PCM 125	C-7498	H3448
59054200	Predator	100 Sq.Ft.	10-1/16"	23-5/8"		59054200	C-9410	H3493
570057	Commander	25 Sq. Ft.	7"	9-13/16"	3"	PCM 25	C-7625	H5251
570142	Commander	35 Sq. Ft.	7"	9-13/16"	3"	PCM 35	C-7435	H5256
570058	Commander	50 Sq. Ft.	7"	19-5/8"	3"	PCM 50	C-7650	H5252
570143	Commander	75 Sq. Ft.	7"	19-5/8"	3"	PCM 75SV	C-7453	H5254
570074	Commander	75 Sq. Ft.	7"	29-3/8"	3"	PCM 75	C-7675	H5253
570144	Commander	100 Sq. Ft.	7"	29-3/8"	3"	PCM100SV	C-7499	H5257
570105	Commander II (In-Line)	25 Sq. Ft.	4-11/16"	11-7/8"	2-1/16"	PA 225	C-4327	H5250
Baker Hydro								
17B1165	Ultra-Mite	50 Sq. Ft.	7"	14-3/4"		PBHUM50	C-7405	H5846
17B1163	Hydro-Mite	12.5 Sq. Ft.	7"	5"		PBH 12.5	C-7603	H5260
17B2054	Hydro-Mite	25 Sq. Ft.	7"	9-13/16"		PBH 25	C-7604	H5261
17B2055	Hdyro-Mite	50 Sq. Ft.	7"	19-5/8"		PBH 50	C-7605	H5262
17B2056	Hydro-Mite	75 Sq. Ft.	7"	29-3/8"		PBH 75	C-7606	H5263
17B2071	Hydro-Mite	100 Sq. Ft.	7"	39-3/8"		PBH 100	C-7607	H5264
Coleco								
F-120	(No Core)	5 Sq. Ft.	4-1/4"	8"	1-15/16"	----	C-4606	H5165
SLM DR-7	(With Core)	5 Sq. Ft.	4-1/4"	8"	1-15/16"	PC7-120	C-4607	H5270
F-108,F110, CR-8	(With Core)	5 Sq. Ft.	4-3/4"	8"	1-1/8" & 2-3/8"	PC 8	C-4609	H5271
F-112,F-350,CR-11	(With Core)	8 Sq. Ft.	4-3/4"	11"	1-1/8" & 2-3/8"	PC 11	C-4611	H5272
F-750,F-850,DR-16	(With Core)	13 Sq. Ft.	4-3/4"	16"	1-1/8" & 2-3/8"	PC 16	C-4616	H5273
F-225,F-335,DR-18	(With Core)	13 Sq. Ft.	4-3/4"	18"	1-1/8" & 2-3/8"	PC 18	C-4618	H5274
F-355,F-455,DR-17	(With Core)	23 Sq. Ft.	6-1/2"	17"	3"	PC 17	C-6617	H5275
F-380,F-480,DR-2 2	(With Core)	30 Sq. Ft.	6-1/2"	22"	3"	PC 22	C-6622	H5276
Doughboy								
3122-1003	(Original)	60 Sq. Ft.	6-15/16"	22-3/8" Closed &	2-1/16"	PD 60	C-6659	H5268
Harmsco								
PH 6	Harmsco	6 Sq. Ft.	2-3/4"	9-3/4"	1-1/16"	PH 6	T-380	H5074
								Case of 100
ST-55	TF 50 & BF-55SC		7-3/4"	9-5/8"	2-5/8" & 3-1/2"	PH 50/55		H2620*
ST-105	TF 100 & BF-105SC		7-3/4"	19-1/2"		PH 100/105		H5009
ST-155	TF 150 & BF-155SC		7-3/4"	29-1/16"		PH 150/155		H5049
TFC75	TF 75		7-3/4"	15-3/16"		PH 75		H5050*
HC/40TC	Hurricane 40		7-3/4"	9-5/8"				H5051
HC/90TC	Hurricane 90		7-3/4"	19-1/2"				H5052
HC/170TC	Hurricane 170		7-3/4"	30-3/4"				H5053
Hayward Pool Products								
C-200RE	MicroStar (In-Line)	20 Sq. Ft.	4-5/8"	11-7/8"	2-1/16"	PA 20	C-4320	H5011
C-225RE	MicroStar (In-Line)	25 Sq. Ft.	4-5/8"	11-7/8"	2-1/16"	PA 225	C-4325	H5014
C-250RE	Star-Clear	25 Sq. Ft.	7"	9-13/16"	3"	PA 25	C-7626	H5017
C-500RE	Star-Clear	50 Sq. Ft.	7"	19-5/8"	3" w/Gskt	PA 50	C-7656	H5018
C-750RE	Star-Clear	75 Sq. Ft.	7"	29-3/8"	3" w/Gskt	PA 75	C-7676	H5019
C-800RE	Star-Clear II	75 Sq. Ft.	8-1/2"	17-1/2"	4-1/16" w/Gskt	PA 80	C-8600	H5022
C-1100RE	Star-Clear II	100 Sq. Ft.	8-1/2"	23-3/8"	4-1/16" w/Gskt	PA 100	C-8610	H5023
CX470XRE	Super S. C. 2000/2020	50 Sq. Ft.	7"	14-3/16"	3" w/Gskt	----	C-7447	H5015
CX570XRE	Super S. C. 3000/3020	75 Sq. Ft.	7"	19-5/8"	3" w/Gskt	PA 75SV	C-7477	H5020
CX870XRE	Super S. C. 4000/4020	100 Sq. Ft.	7"	25-1/2"	3" w/Gskt	PA 100N	C-7487	H5025
CX1260RE	Super S. C. 5000/5020	125 Sq. Ft.	7"	32-1/16"	3" w/Gskt	----	C-7495	H5026
Easy Clear C400		40 Sq.Ft.	7"	14 1/8"		PA40/CX410RE	C-7442	H5027
Easy Clear C550		55 Sq.Ft.	7"	19 5/8"		PA55/CX550RE	C-7455	H5028
Swim Clear C5025 (need 4)		131 Sq.Ft.	7"	32 13/16"		CX1280XRE	C-7494	H5030
CX400RE	SF400 Skim Filter	40 Sq. Ft.	8-1/2"	10-3/4"	4-1/16"	PA40SF	C-8340	H5216
REPL.CARTRIDGE C-5374		65 Sq.Ft.	Fits Rec Warehouse				C-5374	H5278
CX760RE	Star-Clear Plus	75 Sq. Ft.	8-15/16"	17-3/8"	4" w/Gskt	PA76	C-8411	H5819
CX900RE	Star-Clear Plus	90 Sq. Ft.	8-15/16"	17-3/8"	4" w/Gskt	----	C-8409	H5820
CX1200RE	Star-Clear Plus	120 Sq. Ft.	8-15/16"	23-3/8"	4" w/Gskt	----	C-8412	H5822
CX1750RE	Star-Clear Plus	175 Sq. Ft.	8-15/16"	28-3/16"	4" w/Gskt	PA 175	C-8417	H5824

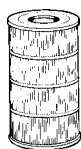
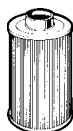

*Non-Stock Item

SWIMMING POOLS (CONT.)

		SQ. FT.	OUTSIDE DIAMETER	OVERALL LENGTH	INSIDE DIAMETER	PLEATCO NO.	DEALER UNICEL NO.	ITEM NO.
Hayward Products (Cont.)								
CX850RE	ASL Full-Flo	85 Sq. Ft.	9-1/4"	14-3/16"	3"	PA 85	C-9485	H5826
CX1250RE	ASL Full-Flo	120 Sq. Ft.	9-1/4"	19-5/8"	3"	PA 125	C-9499	H5828
CX480XRE	Swim Clear	200 Sq. Ft.	7"	14-3/16"		C7458/C2020/C2025		H5829
CX580XRE	Swim Clear	325 Sq. Ft.	7"	19-5/8"		C7483/C3020/C3025		H5831
CX1380RE	Swim Clear	400 Sq. Ft.	7"	25-1/2"		C7433C4020/C4025		H5833
CX875REM	Swim Clear-Microban					C4020/C4025		H5837
Jacuzzi								
42-2891-08-R	CFR-25	25 Sq. Ft.	5"	13-5/16"	2-3/8"	PJ25IN	C-5625	H5096
42-3534-09	CFR-50	50 Sq. Ft.	9-15/16"	10"	5-3/4"	PJ 50	C-9650	H5097
42-3535-08	CFR-75	75 Sq. Ft.	9-15/16"	14-1/4"	5-3/4"	PJ 75	C-9475	H5191
42-3536-07	CFR-100	100 Sq. Ft.	9-15/16"	19-7/8"	5-3/4"	PJ 100	C-9699	H5094
42-3537-06	CFR-150	150 Sq. Ft.	9-15/16"	24"	5-3/4"	PJ 150	C-9478	H5193
42-3540-01	CFR-200	200 Sq. Ft.	9-15/16"	24"	5-3/4"	PJ 200	C-9420	H5484
42-3674-09-R	Sherlock 80	80 Sq. Ft.	10"	14-9/16"	6"	PJ 80	C-9480	H5832
42-3674-09-R	Sherlock 120	120 Sq. Ft.	10"	20-1/16"	6"	PJ 120	C-9481	H5834
42-3675-07-R	Sherlock 160	160 Sq. Ft.	10"	24-5/16"	6"	PJ 160	C-9482	H5836
42-3668-08-R	Sherlock 200	200 Sq. Ft.	10"	29-13/16"	6"	PJ 200S	C-9483	H5838
23-2377-04	CF-25	25 Sq. Ft.	6-7/8"	11-7/8"	3-1/2"	PJ 25	C-6625	H5090
23-2214-01	CF-40	40 Sq. Ft.	6-15/16"	19-3/8"	3-1/2"	PJ 40	C-6640	H5092
23-2297-01	CF-60	60 Sq. Ft.	6-15/16"	29-3/8"	3-1/2"	PJ 60	C-6660	H5093
Jandy								
R0341900		200 Sq. Ft.	12-1/16"	17"	----	----	C-9498	H2080
Jandy CL340		55 Sq. Ft.	7"	27"			C-7459	H2094
Jandy CL460		115 Sq. Ft.	7"	27"	N/A		C-7468	H2096
Jandy CL580 (need 4)		145 Sq. Ft.	7"	33"	N/A		C-7482	H2098
Lomart								
60-4314	(With Core)	13 Sq. Ft.	4-3/4"	18"	1-1/8" & 2-3/8"	PC 18	C-4618	H5274
60-4318	(With Core)	16 Sq. Ft.	4-3/4"	18"	1-1/8" & 2-3/8"	PL 18	C-4601	H5099
Martec Pacific								
SC-2200, SC-3500	Martec	32 Sq. Ft.	4-15/16"	11-7/8"	2-1/8"	PMT 25	C-4332	H5409
CL-2200, CL-2800	Martec	28 Sq. Ft.	4-15/16"	14-7/8"	2-1/8"	PMT 27.5	C-4301	H5408
CL-2807, CL-2810	Martec	50 Sq. Ft.	4-15/16"	14-7/8"	2-1/8"	PMT 50	C-4305	H5410
Muskin								
Muskin	(PMS-8) No Core		4-5/16"	8"	2-3/16"	PMS 8N/C	C-4602	H5482
A3808, A3818	(PMS-8)	6 Sq. Ft.	4-1/2"	8"	2-3/16"	PMS 8	C-4605	H5370
A3810, FE-90	(PMS-10)	10 Sq. Ft.	6-1/4"	8"	2-5/8"	PMS 10	C-6610	H5371
A3816, FE-30	(PMS-16)	16 Sq. Ft.	6-1/4"	8"	2-5/8"	PMS 16	C-6616	H5420
A3821, FD-20	(PMS-20)	20 Sq. Ft.	6-1/4"	8"	2-5/8"	PMS 20	C-6620	H5421
Pac-Fab (Pentair)								
17-4865	Mytilus MY-90/140	6 Sq. Ft.	2-3/4"	9-3/4"	1-1/16"	PH 6	T-380	H5074
17-4821	Mytilus MY-30	23 Sq. Ft.	5-5/16"	13-9/16"	2"	PFAB 30	C-5623	H5120
17-4983	Mytilus FMY-60	60 Sq. Ft.	7-7/8"	14"	3-1/16"	PFAB 60	C-7660	H5155
17-4984	Mytilus FMY-80	80 Sq. Ft.	7-7/8"	22-1/8"	3-1/16"	PFAB 80	C-7680	H5156
17-4981	Mytilus FMY-50	50 Sq. Ft.	7-7/8"	11-1/8"	3-1/16"	PFAB 50	C-7678	H5423
17-4985	Mytilus FMY-100	100 Sq. Ft.	7-7/8"	22-1/8"	3-1/16"	PFAB 100	C-7699	H5157
17-4980	Mytilus FMY-150	150 Sq. Ft.	7-7/8"	33-3/8"	3-1/16"	----	C-7679	H5424
17-8569	Clean & Clear (240)	60 Sq. Ft.	7"	14-1/8"	3"	PCC 60	C-7469	H3443
17-8580	Clean & Clear (320)	80 Sq. Ft.	7"	20"	3"	PCC 80	C-7470	H3444
17-8584	Clean & Clear (420)	105 Sq. Ft.	7"	26-1/16"	3"	PCC 105	C-7471	H3447
17-8585	Clean & Clear (520)	125 Sq. Ft.	7"	32-1/16"	3"	PCC 130	C-7472	H3449
Pleatco								
Skim Filter		15 Sq. Ft.	4-5/8"	6-3/4"	1-9/10"	PVT 25	C-4303	H5840
Skim Filter		50 Sq. Ft.	7"	14-3/4"	1-9/10"	PVT 50	C-7449	H5848
Premier Springwater								
27-077	Hercules	25 Sq. Ft.	5-3/16"	11-7/8"	1-1/16" / 1-5/8"	PPM 25	C-5622	H5378
27-078	Hercules II	25 Sq. Ft.	7"	9-13/16"	3"	PCM 25	C-7625	H5251
27-079	Hercules II	50 Sq. Ft.	7"	19-5/8"	3"	PCM 50	C-7650	H5252
27-080	Hercules II	75 Sq. Ft.	7"	19-5/8"	3"	PCM 75SV	C-7453	H5254

SWIMMING POOLS (CONT.)

		OUTSIDE SQ. FT.	OVERALL DIAMETER	INSIDE LENGTH	DIAMETER	DEALER PLEATCO NO.	UNICEL NO.	ITEM NO.
Purex (Pentair)								
R173308	Purex CF-25	25 Sq. Ft.	7"	11-1/8"	2-15/16"	PPF 25	C-7610	H5192
R173309	Purex CF-33	(3 for CF-100)	7"	14"	2-15/16"	PPF 33	C-7633	H5081
R173311	Purex CF-50 / 150	50 Sq. Ft.	7"	19-5/8"	2-15/16"	PPF 50	C-7651	H5082
R173312	Purex CF-60	60 Sq. Ft.	7"	19-5/8"	2-15/16"	PPF 60	C-7460	H5118
R173313	Purex CF-80	80 Sq. Ft.	7"	19-5/8"	2-15/16"	PPF 80	C-7480	H5122
Rainbow Plastics (Pentair)								
R173220	Lifeguard CL-9X	6 Sq. Ft.	2-3/4"	9-3/4"	1-1/16"	PH 6	T-380	H5074
	American/Pac-Fab/Rainbow	6 Sq. Ft.	2-7/8"	9-3/4"	N/A		C-2606	H5419
17-2056	Lifeguard CL-12.5	12 Sq. Ft.	2-7/8"	14-11/16"	1-1/16"	----	C-2912	H5063
R173200	Lifeguard CL-19X	12 Sq. Ft.	2-7/8"	19-1/2"	1-1/16"	PRB 12	C-2612	H5043
R173327	Lifeguard CL-29	12 Sq. Ft.	2-7/8"	29-1/4"	1-1/16"	PRB 12L	C-2613	H5060
R173328	Lifeguard CL-29X	18 Sq. Ft.	2-7/8"	29-1/4"	1-1/16"	PRB 18	C-2618	H5061
	Rainbow 12.5 filter	13 Sq. Ft.	2-7/8"	14 11/16"	N/A		C-2912	H5063
R173324	Chloro (Conway)	8.5 Sq. Ft.	2-7/8"	17-1/16"	2-1/8"	----	C-2303	H5150
R173425	High Flow (Conway)	14.5 Sq. Ft.	2-7/8"	17-1/16"	1-1/16"	----	C-2302	H5387
R173428	RDC25 (In-Line)	25 Sq. Ft.	4-15/16"	13-5/16"	2-1/8"	PRB 25IN	C-4625	H5059
R173430	RDC/RTL25	37 Sq. Ft.	4-15/16"	13-5/16"	2-1/8"	PRB 37IN	C-4637	H5194
R173434	Lifeguard Top Load	50 Sq. Ft.	4-15/16"	13-5/16"	2-1/8"	PRB 50IN	C-4950	H5413
R173436	RTL-100	100 Sq. Ft.	4-15/16"	26-11/16"	2-1/8"	PRB 100	C-4999	H5048
R173432	DSF-35 (Set of 2)	17.5 Sq. Ft.	4-15/16"	4-5/8"	2-1/8"	PRB37IN	C-4401	H5411
R173433	DSF-50 (Set of 2)	50 Sq. Ft.	4-15/16"	6-5/8"	2-1/8"	PRB 25SF	C-4405	H5412
R173431	DFM-35	35 Sq. Ft.	4-15/16"	9-1/4"	2-1/8"	PRB 35IN3	C-4335	H5481
Recreation Warehouse (Leisure Bay Mfg.)								
111793		37 Sq. Ft.	4-15/16"	13-5/16"	2-1/8"	PRB 37IN	C-4637	H5194
111794		65 Sq. Ft.	7-1/2"	14-13/16"	2-15/16"	PLB 65	C-7415	H5391
111791		100 Sq. Ft.	7-1/2"	20-13/16"	2-15/16"	PLB 100	C-7418	H5390
111792		150 Sq. Ft.	7-1/2"	28-15/16"	2-15/16"	PLB 150	C-7414	H5389
SeasonMaster								
	Model 121	50 Sq. Ft.	5-7/8"	12-3/4"	Top Closed	PLW 50	C-5350	H5487
Sta-Rite								
	Sta-Rite TX-15	15 Sq. Ft.	4-1/2"	9-3/4"	1-1/16"	PSR 15	C-4610	H5124
	WC108-55S2X TX-35	35 Sq. Ft.	8-11/16"	9-3/4"	4-3/16"	PSR 35	SC3-SR35	H5033
	WC108-56S2X TX-50	50 Sq. Ft.	8-11/16"	13-5/16"	4-3/16"	PSR 50	SC3-SR50	H5032
	WC108-57S2X TX-70	70 Sq. Ft.	8-11/16"	18-3/16"	4-3/16"	PSR 70	SC3-SR70	H5035
	WC108-58S2X TX-100	100 Sq. Ft.	8-11/16"	25-11/16"	4-3/16"	PSR 100	SC3-SR100	H5038
	WC108-59S2X TX-135	135 Sq. Ft.	8-11/16"	34-1/4"	4-3/16"	PSR 135	SC3-SR135	H5039
	PTM-135	137 Sq. Ft.	8-11/16"	31-1/4"	N/A		UHD-SR137	H5034
Swimquip (Sta-Rite)								
	24101-19	6 Sq. Ft.	2-3/4"	9-3/4"	1-1/16"	PH 6	T-380	H5074
	24240-0016 RCP25	25 Sq. Ft.	7"	9-13/16"	3"	PCM 25	C-7625	H5251
	24241-0016 FCP-50	50 Sq. Ft.	7"	19-3/8"	3"	PPC 50	C-7652	H5126
Sylvan								
	Sylvan	12 Sq. Ft.	3-1/4"	14-11/16"	1-1/16"	PS 12	C-3612	Z5050
Waterway Plastics								
	817-0010	10 Sq. Ft.	4-1/4"	4"	1-15/16"	PWW 10	C-4310	H5246
	817-2500	25 Sq. Ft.	4-15/16"	13-5/16"	2-1/8"	PRB 25IN3	C-4326	H5277
	817-3510 (set of 2 w/Handle)	35 Sq. Ft.	4-15/16"	4-5/8"	2-1/8"	PRB 17.5SF	C-4401	H5411
	817-0040	40 Sq. Ft.	4-15/16"	11-1/4"	2-1/8"	PWW 40	C-4339	H5830
	817-5010	50 Sq. Ft.	4-15/16"	6-5/8"	2-1/8"	PRB25SF	C-4405	H5412
	817-5000	50 Sq. Ft.	4-15/16"	13-5/16"	2-1/8"	PRB50IN	C-4950	H5413
	817-1000	95 Sq. Ft.	4-15/16"	23-5/8"	2-1/8"	PCAL 100	C-4995	H5299
Wet Institute								
	Modufilter M-66,165, 330	6 Sq. Ft.	2-7/8"	14-11/16"	1-1/16"	PW 15W/C	C-2607	H5383
	Modufilter M-180	60 Sq. Ft.	7-7/8"	14"	3-1/16"	PFAB 60	C-7660	H5155
	Modufilter M-330	105 Sq. Ft.	7-7/8"	22-1/8"	3-1/16"	PFAB 100	C-7699	H5157



SPAS

	SQ. FT.	DESCRIPTION	PLEATCO NO.	UNICEL NO.	ITEM NO.
Alcove Spas					
	8 Sq. Ft.	3-1/4" x 9-3/4"	PS 9	C-3608	H5298
	19 Sq. Ft.	8" w/ 1-1/2" MPT	----	4CH-21	H5801
Artesian Spas (Majestic Ind.)					
	25 Sq. Ft.	7" w/ 1-1/2" MPT	PTL 25WSV	6CH-26	H5247
Aqua Spa					
	20 Sq. Ft.	Cone Handle, Bot 1-7/8" I.D.	PAQ25IN	C-4402	H5414
Baja Spas					
	50 Sq. Ft.	4-15/16" x 13-3/16"	PRB 50IN	C-4950	H5413
	100 Sq. Ft.	4-15/16" x 26"-11/16"	PRB 100	C-4999	H5048
Cal Spas					
	50 Sq. Ft.	4-15/16" x 13-5/16"	PRB 50IN	C-4950	H5413
	50 Sq. Ft.	4-15/16" x 14-7/8"	PMT 50	C-4305	H5410
	100 Sq. Ft.	4-15/16" x 23-5/8"	PCAL 100	C-4995	H5299
Caldera Spas					
	50 Sq. Ft.	7" x 10-3/4"	PCD50	C-7451	H5399
	75 Sq. Ft.	7" x 14-3/4"	PCD 75	C-7479	H5005
Coleman Spas (Calif. Cooperage)					
	40 Sq. Ft.	4-15/16" x 11-1/4" (2-1/8" I.D.)	PWW 40	C-4339	H5830
	32 Sq. Ft.	8" w/ 1-1/2" MPT	PCS 32	7CH-32	H5386
	40 Sq. Ft.	9-3/4" w/ 1-1/2" MPT	PCS 40	7CH-40	H5488
	50 Sq. Ft.	7" x 14-3/4" w/1-1/2" MPT	PCS 50	7CH-50	H5850
	50 Sq. Ft.	14-3/4" w/ 2" MPT	PCS 50-2	7CH-502	H5384
	75 Sq. Ft.	13" w/ 2" Male Slip	PCS 75N	C-8475	H5433
Dimension One Spas					
	25 Sq. Ft.	5-1/2" x 11-7/8" Ozone	PDO 25	C-5402	H5031
	30 Sq. Ft.	11-7/8" w/ 1-1/2" Male Thread	PTL 20	4CH-30	H5265
	40 Sq. Ft.	5-1/2" x 17" Ozone	PDO 40	C-5404	H5485
	40 Sq. Ft.	4-5/8" x 15" w/SAE	----	4CH-940	H5448
	50 Sq. Ft.	14-3/4" w/ 1-1/2" Male Thread	PTL 50	4CH-50	H5036
	65 Sq. Ft.	19-5/8" w/ 1-1/2" Male Thread	PTL 65H	4CH-65	H5037
	75 Sq. Ft.	7" x 10-1/2" w/ SAE	----	7CH-975	H5800
	75 Sq. Ft.	14-3/4" w/ 2" MPT	PTL 75XW-2	7CH-752	H5486
Diamond Back					
	35 Sq. Ft.	6" x 9-7/8"	PTL35W	6CH-35	H5269
Discovery Spa					
	30 Sq. Ft.	14-15/16" x 10-3/8"	----	C-4431	H5483
Fort Wayne Spas (Master Spas)					
	20 Sq. Ft.	6-3/4" w/ 1-1/2" Male Thread	PHC 25	4CH-20	H5199
	45 Sq. Ft.	12-1/4" w/ 1-1/2" Male Thread	PTL 45W	6CH-45	H5041
Fountain Valley Spas					
	45 Sq. Ft.	6-7/8" x 13-3/4" (2" I.D.)	PFV 40	C-6445	H5842
Gerico Spas					
	45 Sq. Ft.	6-15/16" x 17-5/8"	PG 45	C-6645	H5095
Hawkeye Spas					
	50 Sq. Ft.	4-15/16" x 13-5/16"	PRB 50IN	C-4950	H5413
Heldor Spas					
	25 Sq. Ft.	4-15/16" x 13-5/16"	PRB 25IN	C-4625	H5059
	50 Sq. Ft.	4-15/16" x 13-5/16"	PRB 50IN	C-4950	H5413

SPAS (CONT.)

	SQ. FT.	DESCRIPTION	PLEATCO NO.	UNICEL NO.	ITEM NO.
Hot Springs Spas					
(Watkins Mfg.)	30 Sq. Ft.	5-1/8" x 10-1/4"	----	C-5431	H5297
	33 Sq. Ft.	6" x 9"	PWK 35	C-6433	H5295
	35 Sq. Ft.	16" with 1-1/2" Male Thread	PTL 35	4CH-35	H5294
	45 Sq. Ft.	6-3/8" x 11-7/8"	PWK25/40	C-6600	H5425
(After1990)	30 Sq. Ft.	5-1/8" x 10-1/4"	PWK 30	C-6430	H5296
Hot Spot	25 Sq. Ft.	4-15/16" x 13-5/16"	PRB 25IN3	C-4326	H5277
Tiger River	65 Sq. Ft.	8-1/2" x 10-1/2"	PWK 45N	C-8465	H5426
Hydro Spa					
	25 Sq. Ft.	9-3/4" with 1-1/2" Male Thread	PTL 20HS	4CH-24	H5258
Jacuzzi Whirlpool					
Cambio	12 Sq. Ft.	2-7/8" x 19-1/2"	PRB 12	C-2612	H5043
Quanta	30 Sq. Ft.	6-7/8" x 14-7/8"	PJW 30	C-6300	H5089
Avanza, Celeste, Meridian	25 Sq. Ft.	5-3/4" x 11-7/8"	PJW 25	C-5624	H5091
Sienna & Virage					
Caressa, Espree I & II	25 Sq. Ft.	5" x 13-5/16"	PJ25IN	C-5625	H5096
Aero, Caressa, Corsica,	25 Sq. Ft.	5-11/16" x 10-3/8"	PJW 23	C-5601	H5417
Lazer II, Meridian II, Polara,	50 Sq. Ft.	5-11/16" x 10-3/8"	PJW 50	C-5300	H5407
Quantum, Razza, Tirage, Vectra, Vectra II, Venterra & 380					
Jetta Spas					
	60 Sq. Ft.	6" x 16-1/4" w/1-1/2" MPT	----	C6H-60	H5248
La Spas					
	50 Sq. Ft.	6" x 9" w/ MPT	PTL47W	6CH-47	H5432
Lifestyle Spas					
	30 Sq. Ft.	4-15/16" x 10-3/8" (T-closed, B- 2-1/8" I.D.)		C-4431	H5483
Marlin Spas					
	27 Sq. Ft.	5-3/16" x 14-3/4" (1-1/16"/1-5/8")	----	C-5627	H5406
Marquis					
	25 Sq. Ft.	5-3/16" x 11-7/8" (1-1/16"/1-5/8")	----	C-5622	H5378
	25 Sq. Ft.	5-3/16" x 11-7/8" (1-1/16"/1-5/8")	PPM 25	C-5626	H5380
	40 Sq. Ft.	5-3/16" x 19-5/8" (old)	----	C-5636	H5379
	40 Sq. Ft.	5-3/16" x 19-5/8" (old)	PPM 40	C-5637	H5418
	35 Sq. Ft.	5-3/16" x 11-7/8" (T-closed/1-5/8")	----	C-5423	H5045
	50 Sq. Ft.	5-3/16" x 14-1/8" (T-closed/1-5/8")	----	C-5346	H5852
	60 Sq. Ft.	5-3/16" x 19-5/8" (T-closed/1-5/8")	PPM60	C-5434	H5047
	50 Sq. Ft.	5-3/16" x 12-1/2"	N/A	5CH-502	H5397
Martec					
	27.5 Sq. Ft.	4-15/16" x 14-7/8"	PMT27.5	C-4301	H5408
	32 Sq. Ft.	4-15/16" x 11-7/8"	PMT25	C-4332	H5409
	50 Sq. Ft.	4-15/16" x 14-7/8"	PMT50	C-4305	H5410
Master Spas					
	20 Sq. Ft.	6-3/4" x 4-5/8" with 1-1/2" MPT	PHC25	4CH-20	H5199
Nemco					
	25 Sq. Ft.	9-3/4" with 1-1/2" Male Thread	PTL20HS	4CH-24	H5258
	50 Sq. Ft.	14-3/4" with 1-1/2" Male Thread	PTL 50	4CH-50	H5036
	25 Sq. Ft.	4-5/8" x 11-5/8"	PCP 20	C-4403	H5374
	30 Sq. Ft.	4-15/16" x 10-3/8"	DSF 25-50	C-4429	H5415
	50 Sq. Ft.	5-7/8" x 15-5/8"	PCP 50	C-5405	H5416
	25 Sq. Ft.	7" x 9-13/16"	----	C-7624	H5375
PDC Spas					
	50 Sq. Ft.	4-15/16" x 13-5/16"	PRB 50IN	C-4950	H5413
Pageant Spas					
	19 Sq. Ft.	4-5/8" x 8" with 1-1/2" MPT	----	4CH-21	H5801
	60 Sq. Ft.	16-1/8" (B-1-7/8" I.D w Slots)	PSI65	C-6602	H5844



SPAS (CONT.)

	SQ. FT.	DESCRIPTION	PLEATCO NO.	UNICEL NO.	ITEM NO.
Pelican Rec	8 Sq. Ft.	5" x 8" (2-1/4" I.D.)	PPM25	C-5301	H5293
Rainbow Plastics					
Dynamic Series 1 (In-Line)	25 Sq. Ft.	4-15/16" x 13-5/16"	PRB 25IN	C-4625	H5059
Dynamic Series 1, 2 & 3 (In-Line / Top Load)	37 Sq. Ft.	4-15/16" x 13-5/16"	PRB 37IN	C-4637	H5194
Rec. Warehouse (Leisure Bay)					
	25 Sq. Ft.	4-15/16" x 13-5/16" (2-1/8" I.D.)	PRB25IN3	C-4326	H5277
	65 Sq. Ft.	7-1/2" x 14-13/16" (2-1/8" I.D.)	PLB 65	C-7415	H5391
	100 Sq. Ft.	7-1/2" x 20-13/16" (2-15/16" I.D.)	PLB 100	C-7418	H5390
	150 Sq. Ft.	7-1/2" x 28-15/16" (2-15/16" I.D.)	PLB 150	C-7414	H5389
Romanesque	27 Sq. Ft.	5-3/16" x 14-3/4"	PPM 30	C-5627	H5406
Santana (Conger Bros.)					
	25 Sq. Ft.	4-15/16" x 9-13/16" (2-1/8" I.D.)	PPI25	C-4328	H5431
	30 Sq. Ft.	4-15/16" x 11-7/8" (2-1/8" I.D.)	----	C-4430	H5430
	45 Sq. Ft.	4-15/16" x 14-7/8" (Closed)	----	C-4345	H5427
	45 Sq. Ft.	4-15/16" x 14-7/8" (2-1/8")	PMT 45	C-4347	H5429
	45 Sq. Ft.	4-15/16" x 17-3/4" (Closed)	PSI45	C-4346	H5428
Sonfarrel					
	27.5 Sq. Ft.	4-15/16" x 14-7/8"	PMT 27.5	C-4301	H5408
	32 Sq. Ft.	4-15/16" x 11-7/8"	PMT 25	C-4332	H5409
	50 Sq. Ft.	4-15/16" x 14-7/8"	PMT 50	C-4305	H5410
Sonoma Spas					
	25 Sq. Ft.	5-1/2" x 11-7/8" Ozone	PDO 25	C-5402	H5031
	40 Sq. Ft.	5-1/2" x 17" Ozone	PDO 40	C-5404	H5485
Saratoga Spas					
	19 Sq. Ft.	4-5/8" x 8" with 1-1/2" MPT	----	4CH-21	H5801
	20 Sq. Ft.	6-3/4" x 4-5/8" with 1-1/2" MPT	PHC 25	4CH-20	H5199
	25 Sq. Ft.	9-3/4" x 4-5/8" with 1-1/2" MPT	PTL 20HS	4CH-24	H5258
	40 Sq. Ft.		PSG40N-MB		H5861
Softub					
	20 Sq. Ft.	6-3/4" x 4-5/8" with 1-1/2" MPT	PHC 25	4CH-20	H5199
	25 Sq. Ft.	6" x 5-1/2" with 1-1/2" MPT	PTL 20WSV	6CH-25	H5259
Sundance Spas					
	30 Sq. Ft.	11-7/8" with 1-1/2" Male Tread	PTL 20	4CH-30	H5265
	40 Sq. Ft.	4-5/8" x 16-3/4"	PSD 40	C-4440	H5266
	65 Sq. Ft.	8" or 7-1/2" x 14-3/4" (Bot. 2-1/16" I.D.)	PSD 65	C-7465	H5422
	65 Sq. Ft.	8" or 7-1/2" x 14-3/4" (Bot. 2-5/8" I.D.)	PSD 65-2	C-7466	H5267
6540-486	35 Sq. Ft.	16" x 4-5/8"	PTL35	4CH-35	H5294
6540-497	50 Sq. Ft.	14-7/8" X 4-15/16"	PMT50	C-4305	H5410
6540-471	50 Sq. Ft.	13-5/16" x 4-15/16"	PRB 50 IN	C-4950	H5413
6540-483	75 Sq. Ft.	17-3/4" x 7-1/2"	N/A	C-7370	H5119
6540-482	125 Sq. Ft.	18-1/8" x 8-1/2"	PSD85-2002	C-8380	H5446
6540-488	125 Sq. Ft.	19" x 8-1/2"	N/A	C-8326	H5860
6540-501	80 Sq. Ft.	14" x 8-1/2"	PSD85-2002	C8370	H5128
6540-490	125 Sq. Ft.	8-7/8" x 18"	N/A	C8325	H5127
Vita Spa					
	15 Sq. Ft.	4-5/8" x 6-3/4" (1-1/16" I.D.)	PVT 25	C-4303	H5840
	19 Sq. Ft.	4-5/8" x 8" with 1-1/2" MPT	----	4CH-21	H5801
	20 Sq. Ft.	6-3/4" x 4-5/8" with 1-1/2" MPT	PHC 25	4CH-20	H5199
	50 Sq. Ft.	7" x 14-3/4" (1-9/10")	PVT 50	C-7449	H5848
	50 Sq. Ft.	7" x 19-5/8"	PCM 50	C-7650	H5252
	35 Sq. Ft.	9-3/4" with 1-1/2" Male Thread	PTL 35W	6CH-35	H5269
Waterworks	27 Sq. Ft.	5-3/16" x 14-3/4" (1-1/16"/1-5/8")	----	C-5627	H5406



ALADDIN FILTER O-RING KITS

Cartridge Filters

		ITEM NO.
RO KIT 202	American Quantum	H2501
RO KIT 222	Hayward Star Clear Cartridge Filter (25, 50 & 75 Sq Ft.)	H2506
RO KIT 231	Jacuzzi CFR Series Cartridge Filter (50, 75, 100, 150 & 200 Sq. Ft.)	H2510
RO KIT 233	Jacuzzi Tri-Clops Cartridge Filter (75 & 150 Sq. Ft.)	H2512

Sand Filters



RO KIT 320	Hayward GM Series Sand Filters (GM140, 142, 142-6, 152 & 152HV)	H2531
RO KIT 321	Hayward Pro Series Sand Filters (S164T, S166T, S140T, S220T, S244T, S144T, S310T, S180T, S210T, S311X, S311SXV, S360SX S210S, S220S, S244S & S310S)	H2532
RO KIT 322	Hayward S160T Sand Filter	H2534
RO KIT 323	Hayward S200 Sand Filter	H2535
RO KIT 324	Hayward S240 Sand Filter	H2536
RO KIT 360	PacFab, Purex/Triton Tahitian Sand Filter	H2539
RO KIT 364	PacFab, Purex/Triton Tagelus Sand Filter (TA30D, TA35D, TA40D, TA50D, TA60D, TA100D, TA30, TA35, TA40, TA50 & TA60)	H2543

D.E. Filters

RO KIT 499	American Titan S.S. D.E. Filter	H2550
RO KIT 420	Hayward Perflex D.E. Filter (EC65 & EC75) & Earthworks D.E.	H2551
RO KIT 421	Hayward Micro Clear S.S. D.E. Filter	H2552
RO KIT 422	Hayward Perflex D.E. Filter (EC40 & EC50)	H2553
RO KIT 423	Hayward Micro Clear, Vertical Grid, Duralon & Permaglass XL Filter	H2554
RO KIT 430	Jacuzzi Landslide DE Filter & Separation Tank	H2555
RO KIT 460	PacFab, Star Fiberglass D.E. Filter	H2556
RO KIT 475	Sta-Rite Verticle Sand & D.E. Filter (DES51, DES60 & HRS24-01)	H2564

FILTER BASES

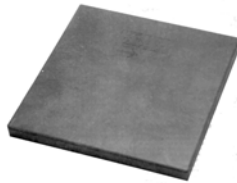

Concrete Filter/Heater Base	24" x 36" x 2"	H8087
Concrete Filter/Heater Pad	24" x 30" x 2"	H8084
DuraGrid Pool Pad - Lightweight*	24" x 36" x 2"	H8090
DuraGrid Pool Pad - Lightweight*	30" x 36" x 2"	H8092
DuraGrid Pool Pad - Lightweight*	30" x 30" x 2"	H8095
DuraGrid Pool Pad - Lightweight*	36" x 48" x 2"	H8096
DuraGrid Pool Pad - Lightweight*	36" x 36" x 2"	H8094
(*Not for use with heaters)		
Ultralite Filter/Equipment Pad*	24" x 36" x 2"	H8085+
(Not suitable for heaters)		

+Limited Stock

MODULATING FLOAT VALVE

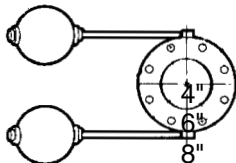

Allows approximately 20% flow from the main drain to the surge chamber.
Poly floats with stainless steel arms. Must be installed on vertical pipe only

Modulating Float Valve	13600-0004*
Modulating Float Valve	13600-0006*
Modulating Float Valve	13600-0008*

*Non-Stock Item
- Add Freight

PRESSURE GAUGES

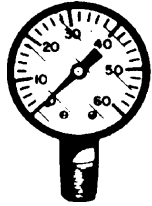

		ITEM NO.
2"	Pressure Gauge (0 - 60 psi) 1/8" Bottom Connection - Metal Case	H7005
2"	Pressure Gauge (0 - 60 psi) 1/4" Bottom Connection - Plastic Case	H7000
2"	Pressure Gauge (0 - 60 psi) 1/4" Bottom Connection - Metal Case	H7003
2"	Pressure Gauge (0 - 60 psi) 1/4" Back Connection - Plastic Case	H7010
2"	Combination Pressure / Vac Gauge 0-50 pressure -- 0-30 Vac 1/4" Back Con.	H7022
4-1/2"	Pressure Gauge (0 - 60 psi) 1/4" Bottom Connection - Metal Case	H7015
	Pressure Gauge (0 - 35 psi) 1/4" Bottom Connection w/ Air relief valve <i>(Rainbow R172013)</i>	H7020
2"	Pressure Gauge (0 - 35 psi) w/ Air Relief Valve - FPT	H7021+
	Pressure Gauge & Adapter - Fits All Valves#125	V5310

VACUUM GAUGES

2"	Vacuum Gauge (0 - 30) 1/4" Bottom Connection - Metal Case	H7025
4-1/2"	Vacuum Gauge (0 - 30) 1/4" Bottom Connection - Metal Case	H7026

SIGHT GLASSES



H8060

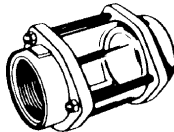

H8062
H8066

1-1/2"	Brass Sight Glass Complete - Vertical	H8060
1-1/2"	Plastic Sight Glass Complete - Vertical	H8065
1-1/2"	In-Line Cylolac Sight Glass (S x S) 1072S	H8062
2"	In-Line Cylolac Sight Glass (S x S) 1074S	H8066
	Sight Glass Bottle with O-Ring SP-710-MA	H8082
1-1/2"	Sight Glass Repair Kit w/Screw	H8078



FISHER PORTER FLOWMETER

Impact tube flow meter with push-button indication. For vertical or horizontal mounting. Meter is adjustable to read four different pipe sizes.

1-1/2" to 3"	Fisher Porter Flowmeter	71K1021A	H7075+ +Limited Stock
--------------	-------------------------	----------	--------------------------

Brass Saddle Clamp

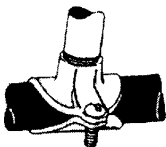

PVC Saddle Clamp



SADDLE CLAMPS WITH TAP

Pipe Size	Material	FPT Tap	
1-1/4"	Bronze Saddle Tee Clamp	x 3/4"	H7085
1-1/2"	Bronze Saddle Tee Clamp	x 3/4"	H7090
2"	Bronze Saddle Tee Clamp	x 3/4"	H7095
Pipe Size	Material	FPT Tap	
2"	PVC Saddle Tee Clamp	x 1-1/2"	U2950
2-1/2"	PVC Saddle Tee Clamp	x 3/4"	U2951
2-1/2"	PVC Saddle Tee Clamp	x 2"	U2955
3"	PVC Saddle Tee Clamp	x 3/4"	U2956
3"	PVC Saddle Tee Clamp	x 2"	U2960
4"	PVC Saddle Tee Clamp	x 3/4"	U2961
4"	PVC Saddle Tee Clamp	x 2"	U2965
6"	PVC Saddle Tee Clamp	x 3/4"	U2966
6"	PVC Saddle Tee Clamp	x 2"	U2970
8"	PVC Saddle Tee Clamp	x 1-1/2"	U2967
10"	PVC Saddle Tee Clamp	x 4"	U27104

BLUE WHITE FLOW METERS

F-300 Series Top Mount for PVC Pipe

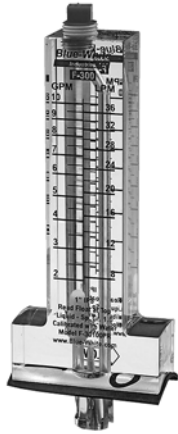

PIPE SIZE		GPM	ITEM NO.
1"	Blue White Flow Meter	5-40	H7024
1-1/4"	Blue White Flow Meter	15-75	H7029
1-1/2"	Blue White Flow Meter	20-100	H7031
2"	Blue White Flow Meter	40-150	H7036
2-1/2"	Blue White Flow Meter	60-240	H7041
3"	Blue White Flow Meter	80-300	H7046
4"	Blue White Flow Meter	125-500	H7051
6"	Blue White Flow Meter	250-1050	H7056
8"	Blue White Flow Meter	500-1900	H7061

Low Range GPM

1"	BlueWhite Flow Meter	2-10	H7023
1-1/2"	Blue White Flow Meter	8-30	H7034
2"	Blue White Flow Meter	15-70	H7039
3"	Blue White Flow Meter	40-140	H7044
1-1/2"	Blue White Flow Meter for Copper Pipe		H7027
2"	Blue White Flow Meter for Copper Pipe		H7028

*Non-Stock Item

ROLA-CHEM[®]
FLOW METERS

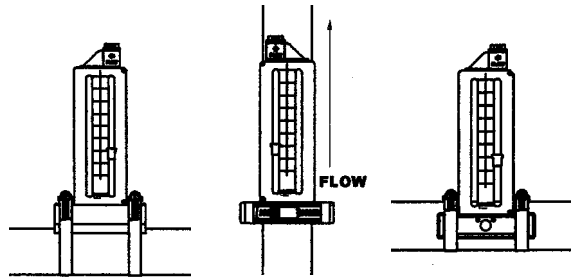

		GPM	ITEM NO.	ITEM NO.	ITEM NO.
			TOP MOUNT	VERTICAL MOUNT	SIDE MOUNT
1-1/2"	Rola-Chem Flow Meter	20-100	H7030	H7032	H7033
2"	Rola-Chem Flow Meter	40-140	H7035	H7037	H7038
2-1/2"	Rola-Chem Flow Meter	60-240	H7040	H7042	H7043
3"	Rola-Chem Flow Meter	100-320	H7045	H7047	H7048
4"	Rola-Chem Flow Meter	150-550	H7050	H7052	H7053
6"	Rola-Chem Flow Meter	300-950	H7055	H7057	H7058
8"	Rola-Chem Flow Meter	600-1800	H7060	H7062	H7063

DIGI-FLO ELECTRONIC FLOWMETER

Accurate, digital meter that is battery powered



- * Saddle mounts on existing pvc pipe
- * Easy to read .35", 6-digit LCD display
- * Factory calibrated, nothing to program
- * Weather resistant ABS enclosure

MODEL NO.	PIPE SIZE	FLOW RANGE GPM	ITEM NO.
RB-150S4-GPM1	1-1/2"	15 - 150	H7110
RB-200S4-GPM1	2"	30 - 300	H7112
RB-300S4-GPM1	3"	60 - 600	H7113*
RB-400S4-GPM1	4"	100 - 1000	H7114*
RB-600S4-GPM1	6"	250 - 2500	H7116
RB-800S4-GPM1	8"	400 - 4000	H7118*

*Non-Stock Item



F-1000RB Digi-Flo



High performance for portable spas,
jetted tubs or above ground pools

FLO-MASTER FMHP SERIES PUMPS- SIDE DISCHARGE

				ITEM NO.
3/4	HP	2-Speed "FMHP" Pump, Less Trap	115V	K5522
1	HP	2-Speed "FMHP" Pump, Less Trap	115V	K5523
1 1/2	HP	2-Speed "FMHP" Pump, Less Trap	115V	K5525
1 1/2	HP	2-Speed "FMHP" Pump, Less Trap	230V	K5526
2	HP	2-Speed "FMHP" Pump, Less Trap	230V	K5527

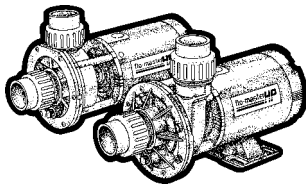

Flo-Master Wet Ends

3/4	HP	Complete "FMHP" Wet End Assembly		K5568
1	HP	Complete "FMHP" Wet End Assembly		K5569
1 1/2	HP	Complete "FMHP" Wet End Assembly		K5570
2	HP	Complete "FMHP" Wet End Assembly		K5578

FLO-MASTER FMCP SERIES PUMPS - CENTER DISCHARGE

3/4	HP	"FMCP" Pump, Less Trap	115V	K5531
1	HP	"FMCP" Pump, Less Trap	115V	K5532
1 1/2	HP	"FMCP" Pump, Less Trap	115V	K5533
3/4	HP	2-Speed "FMCP" Pump, Less Trap	115V	K5534
1	HP	2-Speed "FMCP" Pump, Less Trap	115V	K5535
1 1/2	HP	2-Speed "FMCP" Pump, Less Trap	115V	K5536
1 1/2	HP	2-Speed "FMCP" Pump, Less Trap	230V	K5538
2	HP	2-Speed "FMCP" Pump, Less Trap	230V	K5537

Flo-Master Wet Ends

1/2	HP	Complete "FMCP" Wet End Assembly		K5574
3/4	HP	Complete "FMCP" Wet End Assembly		K5575
1	HP	Complete "FMCP" Wet End Assembly		K5576
1 1/2	HP	Complete "FMCP" Wet End Assembly		K5539
2	HP	Complete "FMCP" Wet End Assembly		K5542

JANDY PUMPS



With full flow 2" unions, large basket & one piece volute/lint pot

2 1/2	HP	Jandy Pump (MHPU)		K2438+
2	HP	Jandy 2-Speed Pump (PHPM)		K2410+

+Limited Stock

Complete
Parts
Breakdown
on Pages
375-377

Stealth Series

Design maximizes hydraulic output while minimizing turbulence & associated noise

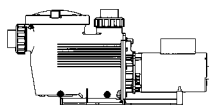

Stealth Series

1	HP	Jandy Stealth Pump (SHPM)	115/230V Up Rated	K2474
1 1/2	HP	Jandy Stealth Pump (SHPM)	115/230V Up Rated	K2476
2	HP	Jandy Stealth Pump (SHPM)	230V Up Rated	K2478
2 1/2	HP	Jandy Stealth Pump (SHPM)	230V Up Rated	K2480
3	HP	Jandy Stealth Pump (SHPF)	230V Full Rated	K2468

2-Speed Series

2	HP	Jandy 2-Speed Pump (SHPM)	230V Up Rated	K2484
2 1/2	HP	Jandy 2-Speed Pump (SHPM)	230V Up Rated	K2486
1-1/2	HP	Jandy 2-Speed Pump (SHPF)	230V Full Rated	K2488
2	HP	Jandy 2-Speed Pump (SHPF)	230V Full Rated	K2490

HAYWARD®



Model No. Max Rated	Model No. Full Rated	NorthStar Performance Data Flow at Total Head					
		40 ft	50 ft	60 ft	70 ft	80 ft	90 ft
SP4007X10NS	SP4007NS	80	70	56	37	—	—
SP4010X15NS	SP4010NS	108	95	82	66	43	—
SP4015X20NS	SP4015NS	131	119	105	88	69	35
SP4020X25NS	SP4020NS	157	142	125	106	84	55
SP4025X30NS	—	179	162	146	128	109	85
—	SP4030NS	206	188	171	154	135	112



NORTHSTAR

High Performance Pump

Designed to maximize flow & minimize noise, simplify service & installation. Features high efficiency motor, CPVC unions, large basket & new Quad-Lock seal design. 10 year warranty on strainer housing.

Complete
Parts
Breakdown
on Pages
374

- 1 HP NorthStar Pump
- 1½ HP NorthStar Pump
- 2 HP NorthStar Pump
- 2½ HP NorthStar Pump
- 3 HP NorthStar Pump

- | | Model No. | SUCTION
SIZE | ITEM NO. |
|--|--------------------|-----------------|----------|
| | SP4007X10NS | 2" | K3940 |
| | SP4010X15NS | 2" | K3945 |
| | SP4015X20NS | 2" | K3950 |
| | SP4020X25NS | 2" | K3955 |
| | SP4025X30NS | 2" | K3960 |



SUPER PUMPS

Model No. Max Rated	Pump Output (GPM) vs. Total Resistance To Flow (Feet of Head)					
	20 ft	30 ft	40 ft	50 ft	60 ft	70 ft
SP2600X5	55	45	29	—	—	—
SP2605X7	67	58	47	31	—	—
SP2607X10	85	76	65	50	27	—
SP2610X15	97	90	80	67	50	10
SP2615X20	116	111	99	85	70	51
SP2621X25	109	109	104	95	84	69

Complete
Parts
Breakdown
on Pages
372

- ½ HP Super Pump
- ¾ HP Super Pump
- 1 HP Super Pump
- 1½ HP Super Pump
- 2 HP Super Pump
- 2½ HP Super Pump

- | | Model No. | SUCTION
SIZE | TRAP
SIZE | ITEM NO. |
|--|------------------|-----------------|--------------|----------|
| | SP2600X5 | 1½" | 5" | K4000 |
| | SP2605X7 | 1½" | 5" | K4002 |
| | SP2607X10 | 1½" | 5" | K4004 |
| | SP2610X15 | 1½" | 5" | K4006 |
| | SP2615X20 | 2" | 5" | K4008 |
| | SP2621X25 | 2" | 5" | K4009 |

2-Speed Pumps

- | | | | | | | |
|-------|----|----------------------|--------------------|--------|----|-------|
| 1 | HP | Super Pump (2-Speed) | SP2607X102S | 1-1/2" | 5" | K3998 |
| 1-1/2 | HP | Super Pump (2-Speed) | SP2610X152S | 1-1/2" | 5" | K4001 |
| 2 | HP | Super Pump (2-Speed) | SP2615X202S | 2" | 5" | K3999 |



SUPER II PUMPS

- | | | | | | | |
|----|----|-------------------------|--------------------|-----|----|-------|
| 1 | HP | Super Pump II | SP3007X10AZ | 1½" | 5" | K4005 |
| 1½ | HP | Super Pump II | SP3010X15AZ | 1½" | 5" | K4007 |
| 2 | HP | Super Pump II | SP3015X20AZ | 2" | 5" | k4011 |
| 2½ | HP | Super Pump II | SP3020X25AZ | 2" | 5" | K4013 |
| 3 | HP | Super Pump II | SP3025X30AZ | 2" | 5" | K4010 |
| 3 | HP | Super Pump II (3-Phase) | SP303063AZ* | 2" | 5" | K4018 |

(*Old Part Number SP3025X303)



HAYWARD®



K4032

Model Number	Pump Output (GPM) vs. Total Resistance To Flow (Feet of Head)				
	10 ft	20 ft	30 ft	40 ft	50 ft
SP1575LX	80	76	64	44	—
SP1580	86	86	75	58	27
SP1580X15	91	91	80	62	32

POWER-FLO LX SERIES PUMPS

					SUCTION SIZE	TRAP SIZE	ITEM NO.
40	GPM	Power-Flo	Pump w/ 6' Cord	SP1540C	1½"	---	K4040
1	HP	Power-Flo LX	Pump w/ 6' Cord <i>Horizontal Discharge</i>	SP1580	1½"	4"	K4032
1½	HP	Power-Flo LX	Pump w/ 6' Cord	SP1580X15	1½"	4"	K4038 <i>+Limited Stock</i>



K4015

Model Number	Pump Output (GPM) vs. Total Resistance To Flow (Feet of Head)				
	10 ft	20 ft	30 ft	40 ft	50 ft
SP1750	55	45	33	15	—
SP1775	65	57	45	30	8
SP1780	78	69	56	40	15
SP1780X15	80	71	59	42	17

POWER-FLO II SERIES PUMPS

½	HP	Power-Flo II Self-Priming	SP1750	1½"	4"	K4015
¾	HP	Power-Flo II Self-Priming	SP1775	1½"	4"	K4024
1	HP	Power-Flo II Self-Priming	SP1780	1½"	4"	K4026

ACCESSORIES

Power-Flo Plus Timer	S1500T	K4046
Union Connectors	SP1500UNPAK2	C1083
Cord Set #14 w/ 6'	SPX1250WA	K4033
Cord Set #16 w/ 6'	SPX1500WA	H6226
Cord Set #14 w/ 25'	SPX1550WA	H6230
1½" Economy ABS Power-Flo Strainer Assy (<i>Trap, Basket, Lid & O-Ring</i>)		K6125

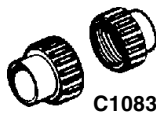

C1083

MAX-FLO PUMPS



½	HP	Max-Flo Pump	SP2800X5	1½"	K4012
¾	HP	Max-Flo Pump	SP2805X7	1½"	K4014
1	HP	Max-Flo Pump	SP2807X10	1½"	K4016
1½	HP	Max-Flo Pump	SP2810X15	1½"	K4017
1½	HP	Max Flo Pump (2 Speed)	SP2810X152		K4029

HAYWARD POWER-FLO MATRIX PUMPS

Matrix Pumps with 6' Cord

					ITEM NO.
3/4	HP	Matrix Pump	SP1591	1 1/2"	K3978
1	HP	Matrix Pump	SP1592	1 1/2"	K3979
1	HP	Matrix Pump (Side Discharge)	SP1592TL	1 1/2"	K3976
1 1/2	HP	Matrix Pump	SP1593	1 1/2"	K3980

Matrix Pumps with Timer and Cord

3/4	HP	Matrix Pump	SP1591FT	1 1/2"	K3981
1	HP	Matrix Pump	SP1592FT	1 1/2"	K3982
1 1/2	HP	Matrix Pump	SP1593FT	1 1/2"	K3983
1	HP	Matrix Pump - 2 Speed	SP15922S	1 1/2"	K3984

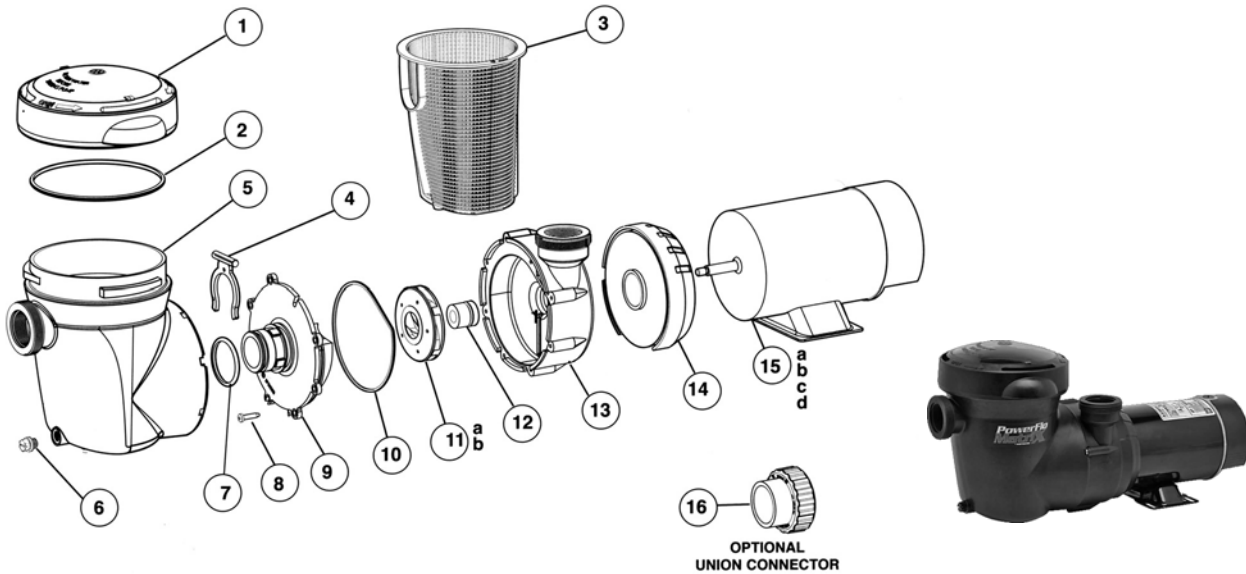

MATRIX PUMP PARTS

Above-ground industry's largest strainer basket; on/off switch; switches from vertical to sidedischarge with push of a button.

REF NO.	PART NO.	DESCRIPTION	ITEM NO.
1	SPX5500D	Strainer Cover w/Lock Ring & 'O'-Ring	K4272
2	SPX5500H	Strainer Cover 'O' Ring	K4275
3	SPX5500F	Strainer Basket	K6141
4	SPX5500G	Strainer Retainer/'C' Clip	K4276
5	SPX5500C	Strainer Housing	K4265
6	SPX1700FG	Drain Plug w/Gasket	K4284
7	SPX5500K	Strainer 'O' Ring	K4277
8	SPX0714Z48	Screw, #14 x 1/4" Type B Pan Head (8)	K4224
9	SPX5500B	Pump Cover	K4223
10	SPX0710XZ5	Housing 'O' Ring	K4207
11a	SPX1500F	3/4 HP Impeller Assembly	K4236
11b	SPX1500L	1 HP Impeller Assembly	K4221
12	SPX1250XZ2C	Shaft Seal Assembly	K6038
13	SPX5500A	Pump Housing	K4206
14	SPX5500E	Shroud Assembly	K4205
15a	SPX1510Z1E	3/4 HP Motor w/Switch	K5055
15b	SPX1510Z1XE	1 HP Motor w/Switch	K5056
15c	SPX1515Z1E	1 1/2 HP Motor w/Switch	K5053
16	SP1500UNPAK2	Union Connector Assembly	C1083

HAYWARD®



**TRISTAR™
HIGH PERFORMANCE PUMP SERIES**

*Superior performance, energy efficiency and value
Advanced fluid dynamic design - three pump elements
to deliver superior flow, and energy efficiency and a
revolutionary design for extended motor life.*



Features:

- Tri-Lock cam and ramp strainer cover
- Easy-to-clean no-rib basket
- Extra large leaf holding capacity to extend the time between cleaning
- Dynamic airflow for quieter, cooler operation
- Optimizes fluid dynamic technology for superior flow
- Desert Rated (designed to operate in environments up to 140° F)
- Seamlessly retrofits into existing pool systems
- Easy to install

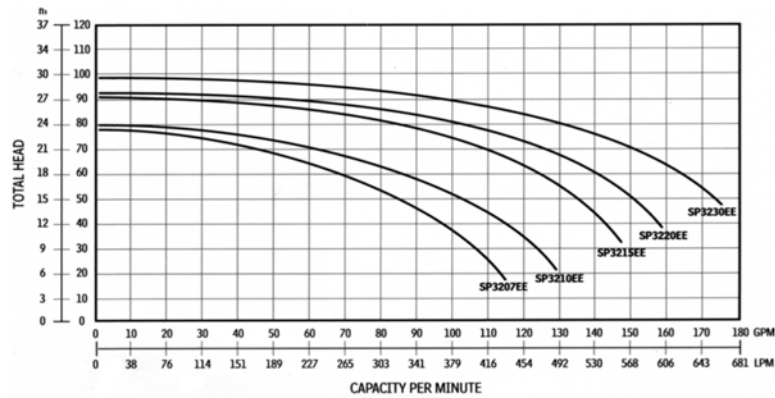

Full Rated				Voltage	Pipe Size	Item No.
1/2	HP	TriStar Pump	SP3205EE	115/208/230	2" / 2 1/2"	K3994
3/4	HP	TriStar Pump	SP3207EE	115/208/230	2" / 2 1/2"	K3985
1	HP	TriStar Pump	SP3210EE	115/208/230	2" / 2 1/2"	K3986
1 1/2	HP	TriStar Pump	SP3215EE	115/208/230	2" / 2 1/2"	K3987
2	HP	TriStar Pump	SP3220EE	115/208/230	2" / 2 1/2"	K3988
3	HP 3 Phase	TriStar Pump	SP323063EE	115/208/230	2" / 2 1/2"	K3989
1	HP	2 Speed	SP32102EE	460	2" / 2 1/2"	K3995
1 1/2	HP	2 Speed	SP32152EE	208/230	2" / 2 1/2"	K3996
2	HP	2 Speed	SP32202EE	208/230	2" / 2 1/2"	K3997



The most trusted name in water™

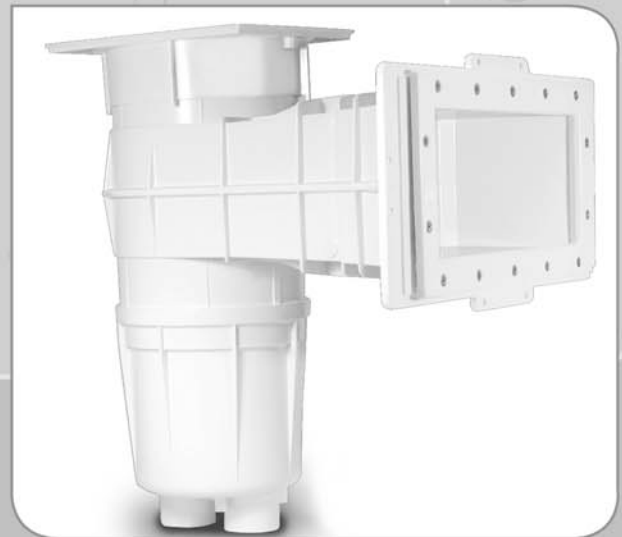

By / Par : Competition Inc.



competition^{INC.}
www.competition-pool.com



JACUZZI

MAGNUM FORCE SERIES PUMPS

High Head pump. Patented Dry Run Seal Protection
Ring Lok Access to Motor & Strainer Basket

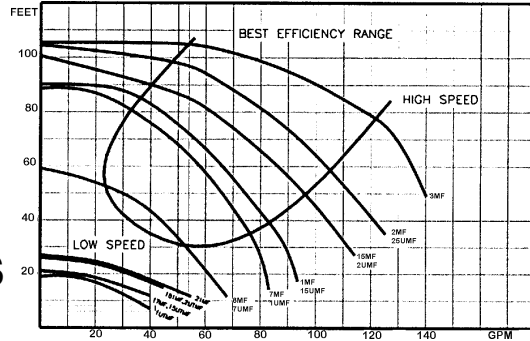

HP	Model	Voltage	Model	Item No.
3/4	Magnum Force Pump	115/230V	7UMF-S	K5800
1	Magnum Force Pump	115/230V	1UMF-S	K5802
1 1/2	Magnum Force Pump	115/230V	15UMF-S	K5804
2	Magnum Force Pump	115/230V	2UMF-S	K5808
2 1/2	Magnum Force Pump	230V	25UMF-S	K5856
1/2	Full Rated) Magnum Force Pump	115/230V	5MF-S	K5831
3/4	(Full Rated) Magnum Force Pump	115/230V	7MF-S	K5832
1	(Full Rated) Magnum Force Pump	115/230V	1MF-S	K5834
1 1/2	(Full Rated) Magnum Force Pump	115/230V	15MF-S	K5836
2	(Full Rated) Magnum Force Pump	230V	2MF-S2	K5838
3	(Full Rated) Magnum Force Pump	208/230/460V	3MF-S2	K5840
1 1/2	(3 Phase) Magnum Force Pump	230V	15MF-T	K5821+
2	(3 Phase) Magnum Plus Pump	230V	RMF-T	K5807+
3	(3-Phase) Magnum Force Pump	208/230/460V	3MF-T	K5842

+Limited Stock

MAGNUM FORCE 2-SPEED SERIES

1	HP	2-Speed Magnum Force Pump	230V	1UTMF-S2	K5858
1 1/2	HP	2-Speed Magnum Force Pump	230V	15UTMF-S2	K5859
2	HP	2-Speed Magnum Force Pump	230V	2UTMF-S2	K5860

MAGNUM FORCE 3

Large Residential/Semi-Commercial Pump

Flows up to 220 GPM. 3" FPT Connections. Run dry features with 2-year warranty against shaft seal damage



3	HP	(1-Phase) Magnum Force 3 Pump	3" Discharge	208/230V	K5814
3	HP	(3-Phase) Magnum Force 3 Pump	3" Discharge	208/230/460V	K5817
5	HP	(1-Phase) Magnum Force 3 Pump	3" Discharge	208/230V	K5816
5	HP	(3-Phase) Magnum Force 3 Pump	3" Discharge	208/230/460V	K5819

CYGNET SERIES

Pool & Spa Pump w /Easy Ring-Lok Access- 2" Plumbing Connections. Run Dry Protection



3/4	HP	Cygnet (Medium Head) Pump	7CYG-S	115/230V	K5810
1	HP	Cygnet (Medium Head) Pump	1CYG-S	115/230V	K5811
1 1/2	HP	Cygnet (Medium Head) Pump	15CYG-S	115/230V	K5812
2	HP	Cygnet (Medium Head) Pump	2CYG-S	115/230V	K5813

JACUZZI "SLR" SERIES PUMPS

Replacement Pump for Above Ground Pool Systems



					Item No.
3/4	HP	"SLR" Pump with 6' Cord	S7LR-6	115V	K5820
1	HP	"SLR" Pump with 6' Cord	S1LR-6	115V	K5822
1 1/2	HP	"SLR" Pump with 6' Cord	S15LR-6	115V	K5827
1 1/2	HP	"SLR" Pump with 6' Cord	S15LR-S	115/230V	K5874



INTELLIFLO VS 3050 HIGH PERFORMANCE PUMP

The IntelliFlo® 4 x160 with programmable, variable speed technology saves energy and money while enabling critical parts to last years longer.



- * Slashes energy costs up to 30% or more
- * Easy to program and operate
- * Offers ultra-quiet operation - just 7-10 decibels or half a human whisper
- * Operates at the minimum speed required for unmatched longevity
- * Compatible with other pool systems including Easy Touch, IntelliTouch, and Sun Touch

IntelliFlo VS 3050 allows the programming of four various speeds ranging from 400 to 3450 RPMs to accomplish different tasks at lowest energy usage.

					Item No.
IntelliFlo VS 3050 Pump	230V	3HP	2" suction		K4047

INTELLIFLO VF HIGH PERFORMANCE VARIABLE SPEED PUMP

IntelliFlo programmable, variable speed pumps are the new standard in pool pumps. IntelliFlo offers onboard intelligence, breakthrough motor technology, and a superior design to deliver energy savings of up to 90%

- * Dramatically reduces energy consumption by 90%, typically saving hundreds each year
- * Reduced operated noise
- * Automatically monitors and adjusts to pool conditions to provide the longest service life of any pump in its class
- * Links to additional water features and equipment to offer expanded control capabilities
- * Compatible with IntelliTouch for RSV85 communication

					Item No.
IntelliFlo VF Pump	230V	3HP	2" suction		K4048



Complete
Parts
Breakdown
on Pages
382

Not All Pumps Stocked

WHISPERFLO

High Performance Pump

Ideal for all cleaning systems, filters and spas. Features new cam & ramp lid design with energy efficient motor. Self-priming - 3 year warranty.

Full Rated - Energy Efficient Motor

					ITEM NO.
½	HP	WhisperFlo Pump - Full Rated - E.E.	115/208-230V	WFE-2	K4159
¾	HP	WhisperFlo Pump - Full Rated - E.E.	115/208-230V	WFE-3	K4160
1	HP	WhisperFlo Pump - Full Rated - E.E.	115/208-230V	WFE-4	K4162
1½	HP	WhisperFlo Pump - Full Rated - E.E.	208-230V	WFE-6	K4164
2	HP	WhisperFlo Pump - Full Rated - E.E.	208-230V	WFE-8	K4166
3	HP	WhisperFlo Pump - Full Rated - E.E.	230V	WFE-12	K4168
1	HP	WhisperFlo Pump (3-Phase)	208-230/460V	WFK-4	K4180
1½	HP	WhisperFlo Pump (3-Phase)	208-230/460V	WFK-6	K4181
2	HP	WhisperFlo Pump (3-Phase)	208-230/460V	WFK-8	K4182
3	HP	WhisperFlo Pump (3-Phase)	208-230/460V	WFK-12	K4183

Full Rated - 2 Speed Motor

1	HP	WhisperFlo Pump - 2-Speed	230V	WFDS-4	K4185
1½	HP	WhisperFlo Pump - 2-Speed	230V	WFDS-6	K4186
2	HP	WhisperFlo Pump - 2-Speed	230V	WFDS-8	K4187

Up-Rated - Energy Efficient Motor

1	HP	WhisperFlo Pump, Up-Rated - E.E.	115/208-230V	WFE-24	K4170
1½	HP	WhisperFlo Pump, Up-Rated - E.E.	115/208-230V	WFE-26	K4172
2	HP	WhisperFlo Pump, Up-Rated - E.E.	208/230V	WFE-28	K4174
2½	HP	WhisperFlo Pump, Up-Rated - E.E.	208/230V	WFE-30	K4176

Up-Rated - Standard Motor

¾	HP	WhisperFlo Pump, Up-Rated - Standard	115/230V	WF-23	K4161*
1	HP	WhisperFlo Pump, Up-Rated - Standard	115/230V	WF-24	K4163*
1½	HP	WhisperFlo Pump, Up-Rated - Standard	115/230V	WF-26	K4165*
2	HP	WhisperFlo Pump, Up-Rated - Standard	115/230V	WF-28	K4167*
2½	HP	WhisperFlo Pump, Up-Rated - Standard	230V	WF-30	K4169*

*Non-Stock Item



Pentair
Pool Products™

CHALLENGER PUMPS

Fiberglass reinforced pump with closed impeller, single speed & two-speed. Standard 2" suction & discharge ports

Complete Parts Breakdown on Pages 378-381

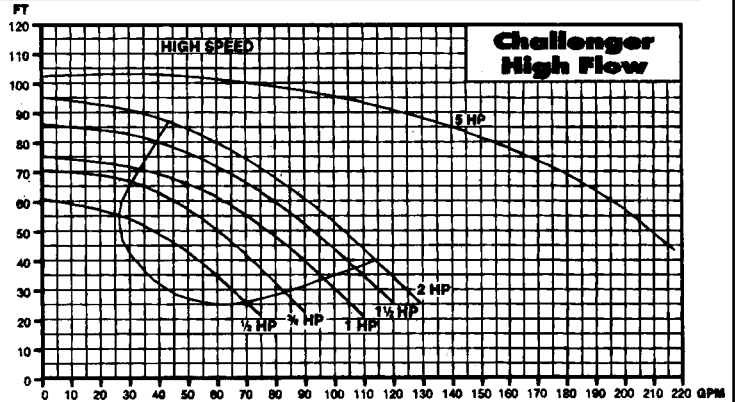

Up-Rated Motors

			Voltage	TRAP SIZE	ITEM NO.
1/2 HP	Challenger Pump	High Pressure	115/230V		K4055
3/4 HP	Challenger Pump	High Flow	115/230V	6"	K4066
		High Pressure	115/230V		K4057
1 HP	Challenger Pump	High Flow	115/230V	6"	K4067
		High Pressure	115/230V		K4058
1 1/2 HP	Challenger Pump	High Flow	115/230V	6"	K4068
		High Pressure	115/230V		K4059
2 HP	Challenger Pump	High Flow	230V	6"	K4069
		High Pressure	115/230V		K4060*
2 1/2 HP	Challenger Pump	High Flow	230V	6"	K4071

Full-Rated Motors

1/2 HP	Challenger Pump	High Flow	115/230V	6"	K4056
1/2 HP	Challenger Pump	High Pressure	115/208/230V	6"	K4119
		<i>with Energy Efficient Motor</i>			
3/4 HP	Challenger Pump	High Flow	115/230V	6"	K4115
1 HP	Challenger Pump	High Pressure	115/230V	6"	K4084
1 HP	Challenger Pump	High Flow	115/208/230V	6"	K4116
		<i>with Energy Efficient Motor</i>			
1 1/2 HP	Challenger Pump	High Flow	208/230V	6"	K4117
		<i>with Energy Efficient Motor</i>			
1 1/2 HP	Challenger Pump	High Pressure	115/230V	6"	K4086
2 HP	Challenger Pump	High Pressure	230V	6"	K4088
2 HP	Challenger Pump	High Flow	208/230V	6"	K4118
		<i>with Energy Efficient Motor</i>			
3 HP	Challenger Pump	High Pressure	208/230V	6"	K4061
3 HP	Challenger Pump	High Pres.(3 Phase)	208/230V6"		K4062

CHALLENGER High Performance Pump

Standard 3" suction & 2" discharge ports with extra-large 8" strainer trap. 3-Year Warranty



5 HP	Challenger Pump hi-flo(1 Phase)	208/230V	8"	K4063
5 HP	Challenger Pump hi-flo(3-Phase)	208/460V	8"	K4064

TWO-SPEED CHALLENGER PUMPS

1 HP	2-Speed Challenger Pump	230V - Up Rated	6"	K4120+
1 1/2 HP	2-Speed Challenger Pump	230V - Up Rated	6"	K4121+
2 HP	2-Speed Challenger Pump	230V - Up Rated	6"	K4122+
2 1/2 HP	2-Speed Challenger Pump	230V - Up Rated	6"	K4123+



SUPERFLO

The SuperFlo pumps are specifically designed to be the best choice for a variety of inground pools. The SuperFlo features thick walled body parts, a heavy duty 56 square flange motor, and highly engineered hydraulics. SuperFlo's silent running capability and small footprint allow it to easily drop into a compact equipment pad.



Pentair Water Pool and Spa, Inc.
Pump Performance Curve
SUPERFLO SERIES

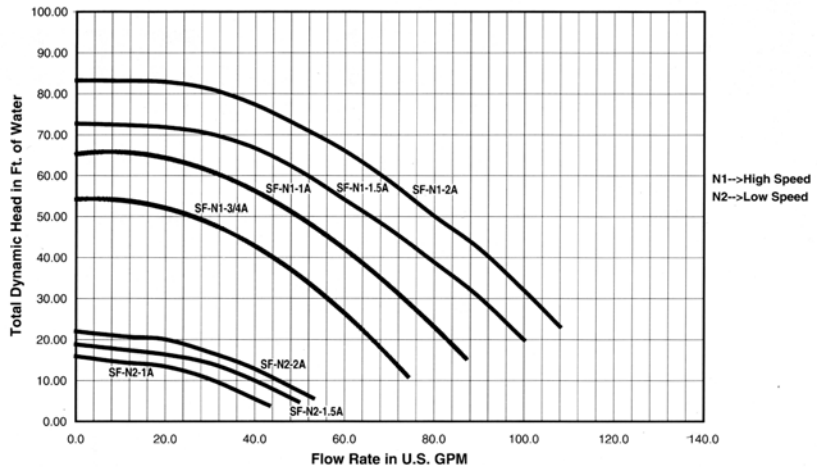

Featured Highlights

- Direct replacement for Hayward Super Pumps
- Extremely quiet operation
- Unionized fittings (1.5 in. and 2 in.)
- Cam and Ramp Lid
- Heavy duty, high service factor 56 square flange motor
- Integral volute and pot reduces hydraulic noise

HP				Voltage	Hz	Mfg. No.	Item No.
3/4	HP	Pentair Superflo Pump With adapter	SF-NI-3/4A	115/230V	60Hz	340037	K4151
1	HP	Pentair Superflo Pump With adapter	SF-NI-1A	115/230V	60Hz	340038	K4153
1 1/2	HP	Pentair Superflo Pump With adapter	SF-NI-1.5A	115/230V	60Hz	340039	K4154
2	HP	Pentair Superflo Pump With adapter	SF-NI-2A	230V	60Hz	340040	K4155

Pentair Superflo Pump Union Kit (Set of 2)

K4145



Pentair
Pool Products™

purex
triton



ULTRA FLOW PUMP

LIMITED STOCK

Ultra quiet, rapid priming pump for both medium & high head installations. Anti spin-off impeller. Service ease volute clamp.



Complete
Parts
Breakdown
on Pages
370

			SIZE	SUCTION SIZE	TRAP ITEM NO.
3/4 HP	Ultra Flow Pump 115/220V	Up-Rated	2"	6"	K2223+
1 HP	Ultra Flow Pump 115/220V	Up-Rated	2"	6"	K2225+
3 HP	Ultra Flow Pump 220V	Full-Rated	2"	6"	K2233+

Energy Efficient



PINNACLE PUMPS (115/230V)

Unibody pump housing with low-profile base

3/4 HP	Pinnacle Pump w/ Square Flange Motor	1 1/2"	6"	K4041*
1 HP	Pinnacle Pump w/ Square Flange Motor	1 1/2"	6"	K4042
1 1/2 HP	Pinnacle Pump w/ Square Flange Motor	1 1/2"	6"	K4043

DYNAMO II PUMPS (115V)

Fiberglass reinforced, self-priming, clear lid. One-year warranty



3/4 HP	Dynamo Pump	1 1/2"	5"	K4090
1 HP	Dynamo Pump	1 1/2"	5"	K4092
1 1/2 HP	Dynamo Pump	1 1/2"	5"	K4094
1 HP	Dynamo Pump w/3 foot cord and switch	1 1/2"	5"	K4091+
1 1/2 HP	Dynamo II Pump(1-Speed)	1 1/2"	5"	K4098+

With 3' Cord and Switch

Two-Speed Pumps

3/4 HP	Dynamite Pump w/o strainer (2-Speed) 115V	1 1/2"	5"	K4093+
1 HP	Dynamo II Pump w/ strainer (2-Speed) 115V	1 1/2"	5"	K4096

*Limited Stock

DURA-GLAS SERIES
High Head Pool / Spa Pump



Original high performance pump known for it's flow rate, rapid priming & easy serviceability.



			SUCTION		TRAP	ITEM NO.
					SIZE	
1/2 HP	Dura-Glas Pump	115/230V	P2RA5CL	1 1/2"	5"	K3051+
3/4 HP	Dura-Glas Pump	115/230V	P2RA5DL	1 1/2"	5"	K3056+
1 HP	Dura-Glas Pump	115/230V	P2RA5EL	1 1/2"	5"	K3061
1 1/2 HP	Dura-Glas Pump	115/230V	P2RA5FL	1 1/2"	5"	K3066



Complete
 Parts
 Breakdown
 on Pages
 383-384

2-Speed Pool / Spa Pump (230V)

1 -1/5 HP	Dura-Glas HL (2-Speed) Pump		P2RA5YEL	1 1/2"	5"	K3160
2 1/3 HP	Dura-Glas HL (2-Speed) Pump		P2RA5YGL	1 1/2"	5"	K3170
	Sta-Rite Dura Glas Pump Lid Wrench		U79-11			K3258
	Sta-Rite Adapter #118 for Dura Glas 2" x 1 1/2"					K3230

MAX-E-GLAS SERIES ENERGY-EFFICIENT (115/230V)

Top-of-the-line energy-efficient Dura-Glas pump. Suitable for commercial & residential applications

1/2 HP	Max-E-Glas Pump (Full-Rated)		PE5CL	1 1/2"	5"	K3125+
1 HP	Max-E-Glas Pump (Full-Rated)		PE5EL	1 1/2"	5"	K3127+

MAX-E-GLASS II SERIES (115/220V)

Combines original Max-E-Glas w/ superior performance characteristics of second generation design.

1 HP	E.E Pump (Up-Rated)		P4EA6E	2"	6"	K3135+
------	---------------------	--	---------------	----	----	--------

MAX-E-PRO SERIES

(E.E. stands for Energy Efficient - Saves on Electric Bills!)

FULL RATED

					ITEM NO.
1/2 HP	MAX-E-PRO E.E. 115/230V		P6E6C-204L		K3000+
3/4 HP	MAX-E-PRO E.E. 115/230V		P6E6D-205L		K3002+
1 HP	MAX-E-PRO E.E. 115/230V		P6E6E-206L		K3004
1 1/2 HP	MAX-E-PRO E.E. 230V		P6E6F-207L		K3006+
2 HP	MAX-E-PRO E.E. 230V		P6E6G-208L		K3008+
3 HP	MAX-E-PRO E.E. 1PH 230V		P6E6H-209L		K3010*

UP-RATED

1 HP	MAX-E-PRO E.E. 115/230V		P6EA6E-205L		K3012+
1 1/2 HP	MAX-E-PRO E.E. 115/230V		P6EA6F-206L		K3014+
2 HP	MAX-E-PRO E.E. 230V		P6EA6G-207L		K3016*
2 1/2 HP	MAX-E-PRO E.E. 230V		P6EAAG-208L		K3018+
1 HP	MAX-E-PRO NON E.E. 115/230V		P6RA6E-205L		K3020
1 1/2 HP	MAX-E-PRO NON E.E. 115/230V		P6RA6F-206F		K3022
2 HP	MAX-E-PRO NON E.E. 230V		P6RA6G-207L		K3024
	2"THR.D.FPT UNION CONN.KIT FOR MAX-E-PRO#PKG-189				K3139

*Non Stock Item
 +Limited Stock

STA-RITE®



DYNA-GLAS SERIES

Self-Priming Medium Head

A self-priming, medium head pump with an extra large, integral hair & lint strainer. The ideal pump where high flow & quiet operation are required. Union fittings optional



				SUCTION SIZE	TRAP SIZE	ITEM NO.
3/4	HP	Dyna-Glas Pump	MPRA6DL	2"	6"	K3130
1	HP	Dyna-Glas Pump	MPRA6EL	2"	6"	K3131
2	HP	Dyna-Glas Pump	MPRA6GL	2"	6"	K3133
		Unions for Dyna-Glas Pumps- 1½" Slip (2/pkg)				K3134
		Union Connector for Dyna-Glas Pumps- 2" Slip (2/pkg)				K3136

DURA JET SPA PUMPS

3/4	HP	115V	Dura Jet Spa Pump	JSADL-2A		K3140+
1	HP	115V	Dura Jet Spa Pump	JSAEL-2A		K3141+
1-1/2	HP	115/220V	Dura Jet Spa Pump	JSAFL-A		K3142+

PLBC SERIES

Booster Pump

1/2	HP	Pool Cleaner Booster Pump			PLBC	K3050+
-----	----	---------------------------	--	--	-------------	--------

LT SERIES

Centrifugal Pump

1/6	HP	Centrifugal Pump			LT1/6L	K3177+
-----	----	------------------	--	--	---------------	--------

**Limited Stock*

STA-RITE STRAINER TRAPS

Includes pot, basket & lid

Pkg. 115	5" Strainer Trap Package for Dura-Glas Pump	K3231
Pkg. 161	6" Strainer Trap Package for Dura-Glas Pump	K3232



ALADDIN GO KITS

Carded Pump & Valve Repair Parts

			ITEM NO.
GO KIT	1	Hayward Max-Flo Series SP-1800 - SP-2800	K6001
GO KIT	2	Hayward Super II Pump Series SP-3000 & SP-3000X	K6013
GO KIT	3	Hayward Super Pump Series SP-1600, SP-2600 & SP-2600X	K6003
GO KIT	4	Pac-Fab 2" Slide Valve Rebuild Kit	K6015
GO KIT	5	Pac-Fab Challenger Pump Rebuild Kit	K6021
GO KIT	6	Sta-Rite P2RA Duraglas/Maxiglas Pump Kit	K6007
GO KIT	7	Anthony 2" Plastic Slide Valve (<i>Fits Part #17810-17770</i>)	K6023
GO KIT	8	Anthony 2" Brass Slide Valve Rebuild Kit	K6025
GO KIT	9	Anthony 1-1/2" Brass Slide Valve Rebuild Kit	K6027
GO KIT	10	Universal 5-Spoke Multiport Rebuild Kit SP-710X & SP-712 (<i>After 1976</i>)	K6029
GO KIT	11	Universal 6-Spoke Multiport Rebuild Kit SP-710 & SP-711 (<i>1969-75</i>)	K6031
GO KIT	12	Hayward Power-Flo SP-1500 & Turbo-Flo 2000-2100 Series	K6005
GO KIT	13	Hayward Power-Flo SP-1700 Series	K6073
GO KIT	14	Jacuzzi Magnum Pump	K6067
GO KIT	16	American Products Americana & Bronze Pump w/Noryl Impeller	K6033
GO KIT	17	American Products Universal Slide Valve Kit 1-1/2" & 2" Bronze & ABS	K6035
GO KIT	18	American Products Multiport Valve Kit Before 1976	K6039
GO KIT	19	American Products Multiport Valve Kit After 1976	K6043
GO KIT	20	American Products Ultra Flow & Bronze Pump w/Bronze Impeller	K6009
GO KIT	21	American Products Eagle Pump Series	K6047
GO KIT	22	Pac-Fab Hydropump Series	K6049
GO KIT	23	Pac-Fab Universal Slide Valve Kit	K6051
GO KIT	24	Pac-Fab Pinnacle Pump Series	K6053
GO KIT	25	Sta-Rite PE & P2RA & AJ Pumps	K6055
GO KIT	26	Sta-Rite CF, CFA & CF6 Pumps	K6057
GO KIT	31	Purex C-Series Commercial Pump	K6069
GO KIT	32	Purex WhisperFlo Pump Series	K6059
GO KIT	33	Purex Aquatron Pump Series	K6061
GO KIT	37	Anthony Universal Slide Valve Kit 1-1/2" & 2" Bronze & ABS	K6068
GO KIT	38	Sta-Rite P4E & P4EA Series Maxiglas II & Duraglas II	K6063
GO KIT	39	Hayward SP-715 Multiport Valve	K6065
GO KIT	54	Sta-Rite P2R & P2RA Duraglas & Maxiglas 1998 to Present	K6076
Pro Box 1		O-Ring Kit - Aladdin	S4140
Pro Box 3		Seal Kit - Aladdin	K6090



ANTHONY REPLACEMENT PARTS

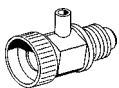

Apollo D.E. Filter

18"	Tank Clamp	Z7007
20"	Tank Clamp	Z7008
18"	Tank O-Ring	H3063
20"	Tank O-Ring	H3064
	Tank Clamp Brass Nut	Z7009
	Bleeder Valve - 1/4"	V4652

Screws for Lights

	Light Face Ring Screw	Z7036
--	-----------------------	-------

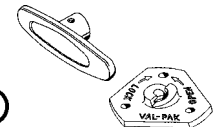
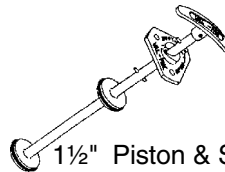

Push-Pull Valve

1 1/2"	Piston & Shaft Complete	Z7012
2"	Piston & Shaft Complete	Z7016
2"	Pac Fab Brass Piston & Shaft	Z7030
1 1/2"	Piston O-Ring Set	Z7018
2"	Piston O-Ring Set	Z7019
2"	Piston O-Ring Set (Plastic Valve)	Z7022
	Valve Stem O-Ring for Bleeder	Z7023
	Piston Handle w/Set Screw	Z7020
1 1/2"	Brass Piston Cap	Z7011
2"	Brass Piston Cap	Z7015

(For complete list & breakdown of parts for Anthony products - Consult Parts Book pages 291-293 & 536)

MOTOR COMPARISON

Compare our standard motors with the E-Plus Energy Efficient "1081" pumps that we stock. Your initial cost is slightly higher but they will end up costing less with reduced energy costs in less than a single season!

A.O. Smith Full Rated Replacement Motor Comparison Sheet - C-face, Threaded Shaft Motors.

Fits Super Pump, Super II, Jacuzzi, Magnum, Argonaut & Baker Hydro Pumps.

Standard Motors vs. E-Plus Energy Efficient "1081" pumps - Under the Efficiency Column we are comparing the standard pump to the more efficient E-Plus pump. The percent shows how much more efficient the E-Plus is than the standard model. Remember, a more efficient pump means lower energy costs:

HP	Volts	Max Amps	Service Factor	Mfg. #	Efficiency	Item#
1/2	115 / 230	11.0 / 5.5	1.6	ST1052	Standard	K5031
1/2	115 / 208-230	7.4 / 4.0-3.7	1.6	B657	38% More Eff.	K5031E
3/4	115 / 230	15.0 / 7.5	1.5	ST1072	Standard	K5032
3/4	115 / 208-230	10.0 / 5.4-5.0	1.5	B638	34% More Eff.	K5032E
1	115 / 230	18.6 / 9.3	1.5	ST1102	Standard	K5034
1	115 / 208-230	11.8 / 6.4 - 5.9	1.4	B654	37% More Eff.	K5034E
1 1/2	115 / 230	19.4 / 9.7	1.3	ST1152	Standard	K5036
1 1/2	115 / 208-230	15.6 / 8.7 - 7.8	1.3	B796	20% More Eff.	K5036E
2	230	11.2	1.3	ST1202	Standard	K5038
2	208-230	10.4 - 9.6	1.2	B809	15% More Eff.	K5038E
3	230	14.4	1.15	ST1302	Standard	K5040
3	208-230	15.0 / 13.6	1.15	B818	8% More Eff.	K5040E

A.O. Smith Up-Rated Replacement motor comparison sheet - Square Flange Motors

Standard Motors vs. E-Plus Energy Efficient "1081". Fits: Challenger, Dura-Glas, Cygnet, Pinnacle & Ultra Flo.

HP	Volts	Max Amps	Service Factor	Mfg. #	Efficiency	Item#
3/4	115 / 230	14.8 / 7.4	1.27	USQ1072	Standard	K5019
3/4	115 / 208-230	8.8 / 4.5 - 4.4	1.25	B862SE	40% More Eff.	K5019E
1	115 / 230	14.8 / 7.4	1.25	USQ1102	Standard	K5021
1	115 / 208-230	11.2 / 6.0 - 5.6	1.25	B863SE	25% More Eff.	K5021E
1 1/2	115 / 230	19.2 / 9.6	1.10	USQ1152	Standard	K5023
1 1/2	115 / 208-230	14.8 / 7.8 - 7.4	1.10	B864SE	33% More Eff.	K5023E
2	115 / 230	10.4	1.10	USA1202	Standard	K5025
2	208 - 230	9.6 - 8.8	1.10	B865SE	12% More Eff.	K5025E
2 1/2	230	11.2	1.0	USQ1252	Standard	K5027
2 1/2	208 - 230	11.0 - 10.0	1.04	B866SE	12% More Eff.	K5027E

THREADED SHAFT NEMA "C" MOTORS (FULL RATED)

A. O. SMITH



*Fits: Super Pump
Super II, J-Series,
Magnum, Argonaut &
Baker Hydro Pumps*

HP	VOLTS	DESCRIPTION	MFG. NO.	ITEM NO.
1/2 HP	115/230V	Threaded Shaft Nema "C" Motor	ST1052	K5031
3/4 HP	115/230V	Threaded Shaft Nema "C" Motor	ST1072	K5032
1 HP	115/230V	Threaded Shaft Nema "C" Motor	ST1102	K5034
1 1/2 HP	115/230V	Threaded Shaft Nema "C" Motor	ST1152	K5036
2 HP	230V	Threaded Shaft Nema "C" Motor	ST1202	K5038
3 HP	230V	Threaded Shaft Nema "C" Motor	ST1302	K5040
2 HP	208-230V/460	Threaded Shaft (3-Phase) Motor	T3202	K5039
3 HP	230/460V	Threaded Shaft (3-Phase) Motor	T3302	K5042

MagneTek



1/2 HP	115/208-230V	Threaded-Shaft Full-Rated Motor	B657	K5031E
3/4 HP	115/208-230V	Threaded-Shaft Full-Rated Motor	B638	K5032E
1 HP	208-230V/115	Threaded-Shaft Full-Rated Motor	B654	K5034E
1 1/2 HP	208-230V/115	Threaded-Shaft Full-Rated Motor	B796	K5036E
2 HP	208-230V	Threaded-Shaft Full-Rated Motor	B809	K5038E
3 HP	208-230V	Threaded-Shaft Full-Rated Motor	B818	K5040E
1/2 HP	115/230V	Threaded Shaft Nema "C" Motor	B126	K5031C
3/4 HP	115/230V	Threaded Shaft Nema "C" Motor	B127	K5032C
1 HP	115/230V	Threaded Shaft Nema "C" Motor	B128	K5034C
1 1/2 HP	115/230V	Threaded Shaft Nema "C" Motor	B129	K5036C
2 HP	230V	Threaded Shaft Nema "C" Motor	B130	K5038C
2 HP	280-230/460	Threaded Shaft Nema "C" Motor	B733	K5039C
3 HP	230V	Threaded Shaft Nema "C" Motor	B131	K5040C

KEYED SHAFT NEMA "C" MOTORS (FULL RATED)

A.O. SMITH



*Fits: Sta-Rite
Bronze, PacFab
Hydro Pump &
Old Style Anthony*

1/2 HP	115/230V	Keyed Shaft Nema "C" Motor	SK1052	K5000
3/4 HP	115/230V	Keyed Shaft Nema "C" Motor	SK1072	K5002
1 HP	115/230V	Keyed Shaft Nema "C" Motor	SK1102	K5004
1 1/2 HP	115/230V	Keyed Shaft Nema "C" Motor	SK1152	K5006
2 HP	230V	Keyed Shaft Nema "C" Motor	SK1202	K5008
3 HP	230V	Keyed Shaft Nema "C" Motor	SK1302	K5010
2 HP	208-220/440V	Keyed Shaft (3 Phase) Motor	K3202	K5009
3 HP	208-220/440V	Keyed Shaft (3 Phase) Motor	K3302	K5012

MagneTek



1/2 HP	115/230V	Keyed Shaft Nema "C" Motor	B120	K5000C
3/4 HP	115/230V	Keyed Shaft Nema "C" Motor	B121	K5002C
1 HP	115/230V	Keyed Shaft Nema "C" Motor	B122	K5004C
1 1/2 HP	115/230V	Keyed Shaft Nema "C" Motor	B123	K5006C
2 HP	230V	Keyed Shaft Nema "C" Motor	B124	K5008C
3 HP	208-230/460V	Keyed Shaft (3 Phase) Motor	H740	K5012C
3/4 HP	115V	2-Speed Keyed Shaft Motor	B972	K5060C
1 HP	230V	2-Speed Keyed Shaft Motor	B974	K5062C
1 1/2 HP	230V	2-Speed Keyed Shaft Motor	B976	K5063C

TWO-SPEED THREADED SHAFT NEMA "C" MOTORS

A. O. SMITH

HP	VOLTS	DESCRIPTION	MFG. NO.	ITEM NO.
3/4 HP	230V	2-Speed Threaded Shaft Motor	STS1072R	K5071
1 HP	230V	2-Speed Threaded Shaft Motor	STS1102R	K5072
1 1/2 HP	230V	2-Speed Threaded Shaft Motor	STS1152R	K5073
2 HP	230V	2-Speed Threaded Shaft Motor	STS1202R	K5033

Magnetek

3/4 HP	115V	2-Speed Threaded Shaft Motor	B973	K5070C
1 HP	230V	2-Speed Threaded Shaft Motor	B975	K5072C
1 1/2 HP	230V	2-Speed Threaded Shaft Motor	B977	K5073C
2 HP	230V	2-Speed Threaded Shaft Motor	B979	K5033C



E-MOD MOTORS (FULL RATED)

SVRS (Safety Vacuum Release System) Built into motor. Meets ASME standard for suction.



1 HP	115/230V	Flanged Magnetek Motor	BE848	K5024M
2 HP	230V	Flanged Magnetek Motor	BE855	K5025M
1 HP	115/230V	Threaded Shaft Magnetek Motor	BE128	K5034M
1 1/2 HP	115/230V	Threaded Shaft Magnetek Motor	BE129	K5036M

SQUARE FLANGE MOTORS (FULL RATED)

A.O SMITH



1/2 HP	115/230V	Square Flange Pool Motor	SQ1052	K5020
3/4 HP	115/230V	Square Flange Pool Motor	SQ1072	K5022
1 HP	115/230V	Square Flange Pool Motor	SQ1102	K5024
1 1/2 HP	230V	Square Flange Pool Motor	SQ1152	K5026
2 HP	230V	Square Flange Pool Motor	SQ1202	K5028
3 HP	230V	Square Flange Pool Motor	SQ1302	K5018
2 HP	230/460V	Square Flange (3-Phase) Motor	Q3202	K5029
3 HP	230/460V	Square Flange (3-Phase) Motor	Q3302	K5037

Magnetek



1/2 HP	115/230V	Square Flange Pool Motor	B846	K5020C
3/4 HP	115/230V	Square Flange Pool Motor	B847	K5022C
1 HP	115/230V	Square Flange Pool Motor	B848	K5024C
1 1/2 HP	230V	Square Flange Pool Motor	B849	K5026C
2 HP	230V	Square Flange Pool Motor	B748	K5028C
3 HP	230V	Square Flange Pool Motor E.E	B844	K5018C
5 HP	208-230V	Square Flange Pool Motor	355705	K4689
2 HP	208-230/460V	Square Flange (3-Phase) Motor	H637	K5029C
3 HP	208-230/460V	Square Flange (3-Phase) Motor	H755	K5037C
5 HP	208-230/460V	Square Flange (3 Phase) Motor	355704	K4687
3 HP	208-230/460V	Square Flange (3-Phase) Motor	H994	K4688

For Pentair Challenger

SQUARE FLANGE MOTORS (UP-RATED)

A.O SMITH

*Fits: Challenger
Dura-Glas, Cygnet
Pinnacle & Ultra Flo*



HP	VOLTS	DESCRIPTION	MFG.NO.	ITEM NO.
3/4 HP	115/230V	Square Flange Up-Rated Motor	USQ1072	K5019
1 HP	115/230V	Square Flange Up-Rated Motor	USQ1102	K5021
1 1/2 HP	230V	Square Flange Up-Rated Motor	USQ1152	K5023
2 HP	230V	Square Flange Up-Rated Motor	USQ1202	K5025
2 1/2 HP	230V	Square Flange Up-Rated Motor	USQ1252	K5027
3/4 HP	208-230V/115	Square Flange Up-Rated Motor	B862SE	K5019E
1 HP	208-230V/115	Square Flange Up-Rated Motor	B863SE	K5021E
1 1/2 HP	208-230V/115	Square Flange Up-Rated Motor	B864SE	K5023E
2 HP	208-230V	Square Flange Up-Rated Motor	B865SE	K5025E
2 1/2 HP	208-230V	Square Flange Up-Rated Motor	B866SE	K5027E
3/4 HP	115/230V	Square Flange Up-Rated Motor	B852	K5019C
1 HP	115/230V	Square Flange Up-Rated Motor	B853	K5021C
1 1/2 HP	230V	Square Flange Up-Rated Motor	B854	K5023C
2 HP	230V	Square Flange Up-Rated Motor	B855	K5025C
2 1/2 HP	230V	Square Flange Up-Rated Motor	B840	K5027C

A.O SMITH



TWO SPEED FLANGED MOTORS

3/4 HP	230V	2-Speed Square Flange Motor	SQS1072R	K5081
1 HP	230V	2-Speed Square Flange Motor	SQS1102R	K5082
1 1/2 HP	230V	2-Speed Square Flange Motor	SQS1152R	K5083
2 HP	230V	2-Speed Square Flange Motor	UQS1202R	K5085
3/4 HP	230V	2-Speed Square Flange Motor	B980	K5080C
3/4 HP	115V	2-Speed Square Flange Motor	B981	K5081C
1 HP	230V	2-Speed Square Flange Motor	B982	K5082C
1 1/2 HP	230V	2-Speed Square Flange Motor	B983	K5083C
2 HP	230V	2-Speed Square Flange Motor	B984	K5085C

POOL MOTORS



3/4 HP	115/230V	Polaris Vac-Sweep Motor (Polaris)	P61	E2P61
3/4 HP	115/230V	Pool Sweep Motor - Vertical Mount	SPS1052	K5050*
3/4 HP	115/230V	Pool Sweep Motor - Horizontal Mount	RPS1052	K5052
3/4 HP	115/230V	Magnetek Horizontal Threaded Motor	B662	K5052C
3/4 HP	115/230V	Letro Horizontal Threaded Motor	B668	K5064C

Total Horsepower X Service Factor of replacement motor must be equal to or greater than that of the original motor being replaced.

**Non-Stock Item
add Freight*

MISC. MOTOR PARTS

A.O Smith Toggle Switch for Matrix Motor	K5110
Terminal Board #6100801	K5112
Governor (All Motors) #601079-1	K5116
Protector for 1 HP #614246-009	K5118
Protector #611123-4	K5120
Switch Kit #608442-1	K5122
A. O. Smith 2-Speed Switch #620035	K5125
Century Switch #157681-01	K5160
Century Stationary Switch #SCN-486	K5136
Franklin Stationary Switch #SKF-6	K5132
GE 2-Speed Switch #114A842AD1	K5128

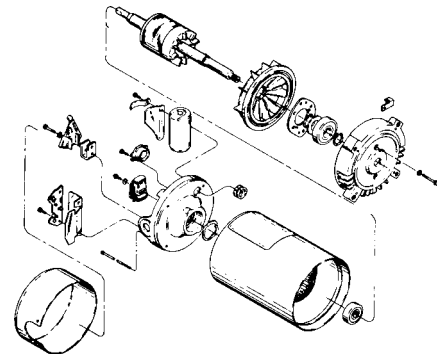

ABOVE GROUND POOL & SPA MOTORS (FULL RATED)



Fits: Maxim
Dynamo, Power-Flo
& Aqua Flo Pumps



HP	VOLTS	DESCRIPTION	MFG NO.	ITEM NO.
1/2	115V	Thru-Bolt Pump Mount Motor	BN23SS	K4272C
3/4	115V	Thru-Bolt Pump Mount Motor	BN24SS	K4246C
1	115V	Thru-Bolt Pump Mount Motor	BN25SS	K4254C
1 1/2	115/230V	Thru-Bolt Pump Mount Motor	BN35SS	K4261C
2	115/230V	Thru-Bolt Pump Mount Motor	BN40SS	K4267C

2-SPEED POOL & SPA MOTORS

3/4	115V	2-Speed Thru-Bolt Mount Motor	BN36	K5055C
1	115V	2-Speed Thru-Bolt Mount Motor	BN37	K5056C
1 1/2	115V	2-Speed Thru-Bolt Mount Motor	BN50	K5057C
1 1/2	230V	2-Speed Thru-bolt Mount Motor	BN34	K5058C
2	230V	2-Speed Thru-Bolt Mount Motor	BN51	K5059C
2 1/2	230V	2-Speed Thru-Bolt Mount Motor	SDS1252	K5061
1	115V	2-Speed Low Amp Start & Run	BN38	K5035C

A.O. SMITH

5	230v	Motor 1800 RM 1 Phase	P317	K9483
---	------	-----------------------	------	-------

+Limited Stock

HAYWARD MATRIX PUMP (NON-STOCK)



3/4	HP	Motor w/ on-off Switch		K5055
1	HP	Motor w/ on-off Switch		K5056

HAYWARD NORTHSTAR

1	HP	Motor Up-rated	USN-1102	K5086C
1 1/2	HP	Motor Up-rated	USN-1152	K5087C
2	HP	Motor Up-rated	USN-1202	K5088C
2 1/2	HP	Motor Up-rated	USN-1252	K5089C
3	HP	Motor Up-rated	USN-1302	K5090C

MARLOW

5	HP	230V	Motor 1 Phase	for 3B-EC-C2	P140	K9478
7 1/2	HP	230V	Motor 1 Phase	for 3B-EC-C2	P318	K9479
5	HP208-230/460		Motor 3 Phase	for 3B-EC-C2	N209	K9481
7 1/2	HP208-230/460		Motor 3 Phase	for 3B-EC-C2	N342	K9482

CAPACITORS



#36-43	Capacitor	K5201
#64-77	Capacitor	K5202
#124	Capacitor	K5200
#189-227	Capacitor	K5203
#161	Capacitor	K5205
#189	Capacitor	K5210
#216	Capacitor	K5212
#243	Capacitor	K5215
#270	Capacitor	K5220
#370 (25 uf)	Capacitor	K5164
#370 (30 uf)	Capacitor	K5166
#370 (35 uf)	Capacitor	K5168
#370 (50 uf)	Capacitor	K5162

MOTOR BEARINGS

#202 Motor Bearing	K5300
#203 Motor Bearing	K5305
#204 Motor Bearing	K5310
#205 Motor Bearing	K5312
#206 Motor Bearing	K5314
#207 Motor Bearing	K5325
#303 Motor Bearing	K5315
#304 Motor Bearing	K5320
Motor Cover (Blue)	K5138
Motor Cover (Brown)	K5139
Electric Motor Cleaner	K5142
Electrical Tape - Roll	K5140

COMMERCIAL PUMP MOTORS

ITEM NO.	HP	PHASE	VOLT	MFG. NO.
K9478	5	1	230	3B-EC2 P231
K9479	7-1/2	1	230	3B32EC-C2-1 P318
K9481	5	3	208-230/460V	3B-EC-C2 E296
K9482	7-1/2	3	200/208	CM-50 W285
K9483	5	1	230	P317
H9454	5	1	230V	C-Series V214
H9455	5	3	220/440V	C-Series R237
H9456	7-1/2	3	220/440V	C-Series R232
H9457	10	3	220/440V	C-Series R338
H9458	15	3	220/440V	C-Series R339
H9459	20	3	220/440V	C-Series R346

**PENTAIR BRONZE C-SERIES REPLACEMENT MOTORS**

K9454*	5	1	230V	71366
K9455	5	3	208/220/440V	71364
K9456	7-1/2	3	208/220/440V	71365
K9457	10	3	208/220/440V	71363
K9459	20	3	208/220/440V	71362

PUMP SEALS

PUMP MANUFACTURER	MFG NO.	SHAFT SIZE	SEAL NO.	ITEM NO.
Alladin "P.R.O 3" Contains 20 Complete Seal Assemblies				K6090
American Products Bronze Pump	395005	3/4"	201	K6032
American Products Ultra Flo	397020	5/8"	1000	K6054
American Products Eagle Pump	397020	5/8"	1000	K6054
American Products Maxim Pump	397012	5/8"	1000	K6054
Sta-Rite Pump Shaft Seal Tool #U807-11B				K3240
Ampro Pump	504D	1/2"	163	K6028
Aqua Flo FMHP & FMCP Pump	92500150	5/8"	200	K6030
Arneson Pool Sweep	A-8B	5/8"	AS-1006	K6022
Anthony AR Bronze Pump	04547	5/8"	1000	K6054
Berkley Pump	142-MPKS	3/4"	750	K6052
Doughboy Pump	306-1002	5/8"	1000	K6054
Hayward Max-Flo Pump	SPX1600-Z-2	5/8"	AS-1521	K6062
Hayward Power-Flo Series Pump	SPX1500-KA	5/8"	AS-4702	K6064
Hayward Power-Flo Seal Housing & O-Ring	SPX1500-KA	5/8"	AS-4702SH	K6064SH
Hayward Power-Flo Series Pump - Kit	SPX1500-KA	5/8"	AS-4702K	K6075
Hayward Super & Super II Pump	SPX1600-Z-2	3/4"	AS-1521	K6062
Homelite Trash Pump	622713-1	1-3/16"	6467	K6060
Jacuzzi Bros. Model P, 8M & ULS	10-1203-01	3/4"	877	K6019
Jacuzzi Bros. L Series	10-1436-00	5/8"	200	K6030
Jandy HHP, MHP & MHPU Series	R0338200	---	---	K6058
Lomart Pump	40-209	1/2"	163	K6028
Marlow Cast Iron EC-B & EC-A Pumps	25353-00	5/8"	411	K6042
Marlow Cast Iron EC 5 HP & 7-1/2 HP	27223-00	1-1/4"	416A	K6046
Marlow Mardur Pump	38592-00	3/4"	201	K6032
Pac-Fab Challenger Pump	35-4545	5/8"	200	K6030
Pac-Fab Dynamo Pump	35-4545	5/8"	200	K6030
Pac-Fab Hydro Pump	35-4001	3/4"	201	K6032
Pac-Fab Pinnacle Pump	35-4545	5/8"	200	K6030
Polaris Vac-Sweep Pump	P-55	5/8"	1000	K6054
Premier Pump	P19-0 & 31-813	5/8"	1000	K6054
Purex Aquatron Pump	71733 (P28322)	5/8"	AS-1212	K6066
Purex AH Series Pump	71728 (P28300)	3/4"	201	K6032
Purex C Series Pump	71725 (P28175)	1"	360	K6036
Purex L Series Pump	71728 (P28300)	3/4"	201	K6032
Purex Whisperflo Pump	71734 (P28323)	5/8"	1000	K6054
Sta-Rite 3 & 5 HP D Series Pumps	U109-0-47	1"	380	K6040
Sta-Rite 3 & 5 HP D Series		1-1/4"	381	K6041
Sta-Rite AJ & PLBC Booster Pumps	U109-93SS	5/8"	100	K6024
Sta-Rite CF & CFA Series Pumps	U109-136SS	5/8"	1000	K6054
Sta-Rite Dura+Max Glass II w/ Copper Insert	U109-372SS	5/8"		K3457
Sta-Rite D Series Pump	U109-433	1-1/4"	381	K6072
Sta-Rite LT Series Pump	U109-68SS	1/2"	163	K6028
Sta-Rite PE & PEA Max-E-Glas	U109-93SS	5/8"	100	K6024
Sta-Rite P2R & P2RA Dura-Glas (Pre 1998)	U109-93SS	5/8"	100	K6024
Speck 4 HP Pump	2920343311	20mm	433.5	K6078
Swimquip XL-VI & XL-VII Pumps	37407-0019	3/4"	201	K6032
Wet Institute Pump	1000	5/8"	1000	K6054

PUMP GASKETS

Anthony Sweep Gaskets			K6008	Bag of 10
Hayward 7-Hole Pump Gaskets	SPX1500-H		K6012	Bag of 10
Marlow 4-Hole Pump Gaskets			K6004	Bag of 10
Sta-Rite 4-Hole Pump Gaskets	C20-72		K6002	Bag of 10
Sta-Rite No Hole Pump Gaskets			K6000	Bag of 10
Sta-Rite Small 4-Hole Gasket	C20-123		K3442	Each (1)

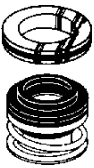

K6012

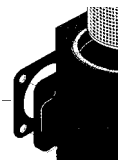

K3442

JANDY (LAARS) LX SERIES HEATERS

Advanced Design Pool & Spa Heaters



- AquaLink RS Compatible
- Intuitive Graphic User Interface
- Fan Assisted Combustion
- Lightweight Polymer Headers
- Low NOx



	ITEM NO.
LX250 Heater - Natural	J6034
LX250 Heater - Propane	J6024
LX400 Heater - Natural	J6038
LX400 Heater - Propane	J6028

Complete
Parts
Breakdown
on Pages
405-409

JANDY LXI HEATERS

LXi250 Heater - Natural	J6012
LXi250 Heater - Propane	J6022
LXi400 Heater - Natural	J6016
LXi400 Heater - Propane	J6026

JANDY LX & LXI HEATER ACCESSORIES

EZ Wireless Remote Control	#7664	J6050
Automatic Cleaner Interlock Relay	#7549	J6054
Freeze Protection (Adjustable Sensor Kit)		V5845



"LT" Series Heaters Available by Special Order

Hi-E2™ GAS HEATERS

- High Performance 95% Efficient
- ASME Certification for Commercial Use
- Dual Electronic Thermostats
- Forced Air Combustion
- Revolutionary Burner Design
- New V12 Heat Exchanger Design
- 5-Year Limited Warranty



Hi-E2 - Natural	EHE350-NC	J6008
Hi-E2 - Propane	EHE350-PC	J6010

JANDY (LAARS) XL-3 OIL HEATERS

Top Not Included

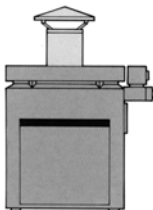

Jandy Oil Heater- 315,000 BTU <i>with Stainless Steel Heat Exchanger</i>	DP3000	J1095+
Top for Oil Heater	D-149	J1097+

+Limited Stock

JANDY (LAARS) LITE2 ELECTRONIC HEATERS



Natural Gas

Electronic Heater

MODEL	BTU	ITEM NO.
LJ125N	125K	J1390
LJ175N	175K	J1391
LJ250N	250K	J1392
LJ325N	325K	J1393
LJ400N	400K	J1394

- * Liquid Crystal Digital Display
- * High Energy Efficiency
- * Ceramic Fiber Combustion Chamber
- * Over 30% Lighter
- * Temperature Controls
- * Hot Surface Ignition or Standing Pilot
- * Reversible Heat Exchanger

Propane Gas

Electronic Heater

MODEL	BTU	ITEM NO.
LJ125P	125K	J1395
LJ175P	175K	J1396
LJ250P	250K	J1397
LJ325P	325K	J1398
LJ400P	400K	J1399

Complete
Parts
Breakdown
on Pages
400-404

JANDY (LAARS) LITE2 MILLIVOLT HEATERS

Natural Gas

Millivolt Heater

MODEL	BTU	ITEM NO.
LG125N	125K	J1111+
LG175N	175K	J1113+
LG250N	250K	J1115
LG325N	325K	J1117+
LG400N	400K	J1119

Propane Gas

Millivolt Heater

MODEL	BTU	ITEM NO.
LG125P	125K	J1101+
LG175P	175K	J1103+
LG250P	250K	J1105
LG325P	325K	J1107+
LG400P	400K	J1109

+Limited Stock



TOPS FOR JANDY (LAARS) HEATERS

Indoor DraftHoods

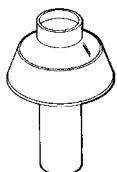

INDOOR
DRAFTHOOD

MODEL	ITEM NO.
125	J1120
175	J1122
250	J1124
325	J1126
400	J1128



OUTDOOR
VENT CAP

Outdoor Vent Caps

MODEL	ITEM NO.
125	J1081
175	J1083
250	J1085
325	J1087
400	J1089

RAYPAK DIGITAL ELECTRONIC SERIES

Digital Control with LCD Display Includes Capron Resin Headers.
High efficiency with guaranteed high wind reliability.



Optional Cupro-Nickel Heat Exchangers are Essential for Salt Water Pools

Complete Parts Breakdown on Pages 423-427



Copper Heat Exchange

MODEL	BTU	ITEM NO.
Natural		
P-R130A	130	J1460
P-R206A	206	J1470
P-R266A	266	J1472
P-R336A	336	J1474
P-R406A	406	J1476
Propane		
P-R130A	130	J1461
P-R206A	206	J1471
P-R266A	266	J1473
P-R336A	336	J1475
P-R406A	406	J1477

Cupro-Nickel Heat Exchange

MODEL	BTU	ITEM NO.
P-R206A-EN-X	206	J1430
P-R266A-EN-X	266	J1431
P-R336A-EN-X	336	J1432
P-R406A-EN-X	406	J1433
EP Series		
P-R206A-EP-X	206	J1434
P-R266A-EP-X	266	J1435
P-R336A-EP-X	336	J1436
P-R406A-EP-X	406	J1437

Tops for Indoor Installation

R206	(6")	J1441
R266	(7")	J1443
R336	(8")	J1445
R406	(9")	J1447

MOST COMMON RAYPAK DIGITAL ELECTRONIC PARTS

	Mfg No.	206A	266A	336A	406A	Item No.
Burner Orifice Natural	350079F	*	*	*	*	J1541
Burner Orifice Propane	350083F	*	*	*	*	J1531
Temperature Sensor IID Units	009577F	*	*	*	*	J5213
Heat Exchanger Assembly Copper	010043F	*				J2344
Heat Exchanger Assembly Copper	010044F		*			J2345
Heat Exchanger Assembly Copper	010045F			*		J2346
Heat Exchanger Assembly Copper	010046F				*	J2347
Heat Exchanger Assembly Cupro Nickel	010356F	*				J2348
Heat Exchanger Assembly Cupro Nickel	010357F		*			J2349
Heat Exchanger Assembly Cupro Nickel	010358F			*		J2350
Heat Exchanger Assembly Cupro Nickel	010359F				*	J2351
Tube Bundle Copper	010059F	*				J2352
Tube Bundle Copper	010060F		*			J2353
Tube Bundle Copper	010061F			*		J2354
Tube Bundle Copper	010062F				*	J2355
Tube Bundle Cupro Nickel	010364F	*				J2356
Tube Bundle Cupro Nickel	010365F		*			J2357
Tube Bundle Cupro Nickel	010366F			*		J2358
Tube Bundle Cupro Nickel	010367F				*	J2359
PRV 125 PSI	008091F	*				J1602
PRV 125 PSI	011912F		*	*	*	J2360

RAYPAK (RP2100) MILLIVOLT PLUS SERIES

Features Capron Resin Headers. Completely Field Serviceable

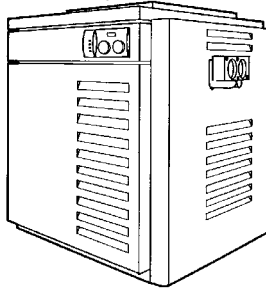

Natural

Price Includes Outdoor Top

P-R206A	J1421
P-R266A	J1423
P-R336A	J1425
P-R406A	J1427

Propane

P-R206A	J1411
P-R266A	J1413
P-R336A	J1415
P-R406A	J1417

Complete
Parts
Breakdown
on Pages
423-427

POWER VENTS

Use to side-wall vent flue gases up to 100 feet.

Raypak 009832 D-2 Power Vent for 206/267 Heaters - New Model	J5020
Raypak 009833 D-2 Power Vent for 333/407 Heaters - New Model	J5022

RAYPAK VERSA MILLIVOLT

Top Not Included *



Natural

B-055B-MN	J1226
P-R130A-MN-C	J1227

Propane

B-055B-MP	J1222
P-R130A-MP-C	J1221



RAYPAK VERSA ELECTRONIC

Top Not Included *

Natural

B-055B-EN (Spa Heater)	J1451
P-R130A-EN-C	J1460

Propane

B-055B-EP (Spa Heater)	J1453
P-R130A-EP-C	J1461

* Please specify which top you require when ordering Versa series

Raypak Tops for Versa Series Heaters

MODEL	OUTDOOR	INDOOR	HIGH WIND
B-055B	J1230	J1234	N/A
B-155B	J1228	J1232	J1952

MOST COMMON RAYPAK PARTS

DESCRIPTION	MFG. NO.	Versa M.V.	Versa IID	RP2100 M.V.	RP2100 IID	ITEM NO.
Flange Gasket - 1-1/2" (Set of 2)	062236B	*	*	*	*	J1675
Flange Gasket - 2" (Each)	800080B	*	*	*	*	J1641
Gas Valve - Natural - M.V.	003898F	*		*		J1538
Gas Valve - Propane - M.V.	003899F	*		*		J1539
Gas Valve - Natural - IID	003900F		*		*	J1569
Gas Valve - Propane - IID	004306F		*		*	J1570
Header Gasket (9/Pack)	800014B	*	*	*	*	J1670
Hi-Limit 135 Degree	600892B	*	*	*	*	J1545
Hi-Limit 140 Degree	600893B	*	*	*	*	J1546
Hi Tension Wire	002654B		*		*	J1591
Ignition Control - Natural	004817B		*		*	J1585
Ignition Control - Propane	004818B		*		*	J1587
Pilot Assembly - Natural - M.V.	600525B	*		*		J1536
Pilot Assembly - Propane - M.V.	600575B	*		*		J1537
Pilot Assembly - Natural - IID	002003F		*		*	J1590
Pilot Generator	600019B	*	*			J1534
Pressure Switch	062237B	*	*	*	*	J1535
Return Header - Cast Iron	002450F	*	*	*	*	J1659
Thermostat - IID	005390F		*			J1499
Thermostat - P.C. Board	005241F				*	J1945
Thermostat - Mechanical	600827B	*		*		J1555
Transformer (Old #005345F / #650531)	006736F		*		*	J5214
Touch Pad Only	009184F		*		*	J5211
Controller PCBoard Kit	010253F		*		*	J1947
Inlet / Outlet Capron Header	006706F			*	*	J5196
Return for Capron Header	006707F			*	*	J5198
Capron Header Gasket (2 O-Rings)	006713F			*	*	J5202
Capron Drain Plug (2)	006721F			*	*	J5200
Capron Unitherm Goo	006719F			*	*	J5194
Capron Flange O-Ring (2)	006724F			*	*	J5204
Capron High Limit Reset	006725F			*	*	J5790
Capron Pressure Switch	006737F			*	*	J5188
Capron Temp. Sensor	006701F			*	*	J5212

Pentair Master Temp Electronic Ignition Low NOx Emission



- Heats up fast so no long waits before enjoying your pool or spa
- Best-in-class energy efficiency
- Manual gas shut-off when service is required
- Eco-friendly MasterTemp is certified for low NOx emission and outperforms industry standards
- Rotating digital display allows for easy viewing
- Tough, rustproof exterior handles the heat and weathers the elements

BTU	NATURAL GAS ITEM NO.	PROPANE ITEM NO.
200	J7602	J7612
250	J7604	J7614
300	J7606	J7616
400	J7608	J7618

Heater Tops

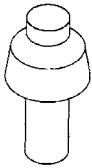

Indoor
Drafthood

250	J1381
300	J1386
400	J1382

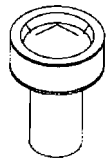

High Wind
Top

250	J1384
300	J1387
400	J1385

MINIMAX NT STANDARD

“ASME” Heaters Available

High Performance Electronic Heaters

Natural Gas

	ITEM NO.
MiniMax NT 300 Heater - Natural	J7506+
MiniMax NT 400 Heater - Natural	J7508+

Propane Gas

MiniMax NT 400 Heater - Propane	J7518+
---------------------------------	--------

- FAN-ASSISTED EXHAUST VENTILATION
- THERMAL EFFICIENCY IN EXCESS OF 82%
- CORROSION RESISTANT COMPOSITE HEADERS
- HOT SURFACE IGNITION FOR FAST HEAT-UP
- COMPOSITE TOP & ALUMINUM EXTERIOR

+Limited Stock

Complete
Parts
Breakdown
on Pages
412-418

MOST COMMON MINIMAX HEATER PARTS

DESCRIPTION	MFG. NO.	ITEM NO.
Accessory Bag Kit for NT	47-1731	J4524
Bulkhead Adapter Nut for NT	27-4440	J4526
Bulkhead Adapter for NT	47-1441	J4528
Gas Valve - Natural - IID	07-3998	K9611
Gas Valve - Propane - IID	07-3999	K9612
Tube Seal Gasket - Each - (18 Required)	07-0951	K9578
Ignition Control Module - Natural	07-3584	K9593
Ignition Control Module - Propane	07-3585	K9594
Pilot Assembly - Natural - IID	47-1204	K9568
Pilot Assembly - Propane - IID	47-1205	K9569
Pressure Relief Valve - 3/4"	07-2138	J4308
Pressure Switch - Barksdale	07-1580	K9326
Return Header	07-0994	K9574
Thermal Cut-off	07-5173	K9603
Thermostat Assembly - IID	07-0271	K9592
Transformer (Dual Volt)	471360	J4313



STA-RITE MAX-E-THERM HEATERS **MAX-E-THERM™**

For indoor or outdoor installations on residential or commercial pools & spas. Features include a LED temperature readout with dual temperature controls, temperature safety lockout, & 6-position control panel. PMG burner technology requires no outdoor draft hood.



Gas Conversion Kits Available

Natural Gas Heaters

	ITEM NO.
200 BTU Max-E-Therm Heater	J7000
333 BTU Max-E-Therm Heater	J7004
400 BTU Max-E-Therm Heater	J7008

Propane Heaters

200 BTU Max-E-Therm Heater	J7010
333 BTU Max-E-Therm Heater	J7014
400 BTU Max-E-Therm Heater	J7018

Z-Flex Venting Equipment

4" Vent Pipe x 4'	PS1341
4" 90 Deg. Elbow	PS1335*
4" 45 Deg. Elbow	PS1337*
4" Wall Thimble for Gas Vent	PS1339*
4" Vent Termination Box	PS1443
4" Condensation Drain Tee	PS1333*
Condensation Drain Tube Kit	PS1331*

*Non-Stock Item

MOST COMMON STA-RITE & PENTAIR MASTERTEMP HEATER PARTS

DESCRIPTION	MFG. NO.	ITEM NO.
Appliance Adapter - S.S.	77707-0087	J7316
Combo Gas Valve - 400 (Natural)	42001-0051S	J7158
Control Board Kit (Natural & LP)	42001-0096S	J7136
Conversion Kit - 400 (LP to Natural)	77707-1311	J7196
Ignition Control Module (all heaters)	42001-0052S	J7128
Ignitor Gasket Kit (all heaters)	77707-0054	J7110
Manifold O-Ring (LP)	35505-7432S	J7276
Orifice Kit - 400 (Natural)	77707-0311	J7166
Pressure Switch (LP)	42001-0060S	J7268
Stack Flue Sensor Kit	42002-024S	J7141
Thermal Regulator Kit	77707-0010	J7292
Thermistor (all heaters)	42001-0053S	J7120
Transformer (all heaters)	42001-0057S	J7130

HAYWARD H-SERIES POOL & SPA HEATERS



Natural Gas	H3001	300,000 BTU Millivolt, Natural Gas	J2836*
	H4001	400,000 BTU Millivolt, Natural Gas	J2848+
Propane	H300P1	300,000 BTU Millivolt, Propane	J2846+
	H400P1	400,000 BTU Millivolt, Propane	J2847+

+Limited Stock

Hayward Universal H-Series Heater

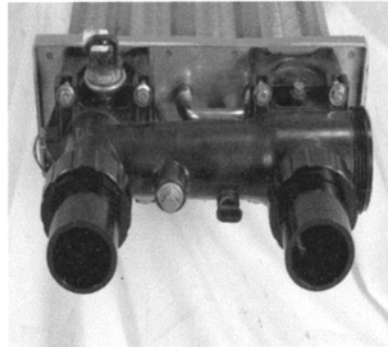

Features:

- ◆ Forced Draft Combustion System - No High Wind Stacks
- ◆ Patent Pending New Header Design - Industry Leading Hydraulic Performance
 - ◆ Unique 'Flapper' Design, Easy Access Bypass Valve
 - ◆ 'Dry' Tube Sheet
- ◆ Totally Managed Flow - All Heat Exchanger Tubes Have Same Water Flow Velocity
 - ◆ Virtually Eliminates Erosion / Improves Reliability & Heat Transfer
- ◆ Durable & Reliable Silicon Nitride, Hot Surface Ignition
- ◆ Independent Left/Right Side Electric, Gas, & Water Options
- ◆ Certified for Installation on Combustible Surfaces
- ◆ Easy Heat Exchanger Rotation - No Header Removal
- ◆ Tough Polypropylene Body Side Panels Resist Rough Handling
- ◆ Lowest Height in the Industry for Unobtrusive Equipment Pad
- ◆ 25% Lighter Weight for Less Physical Effort to Handle & Install
- ◆ 2" x 2-1/2" CPVC Unions (Tristar Style)

◆ Energy Saving Lowest Pressure Drop Through the Heat Exchanger in the Industry.

◆ Balanced / Controlled Water Velocity Through All Tubes (High Velocity Leads to Erosion)

◆ Virtually Eliminates Erosion, Improves Reliability and Heat Transfer

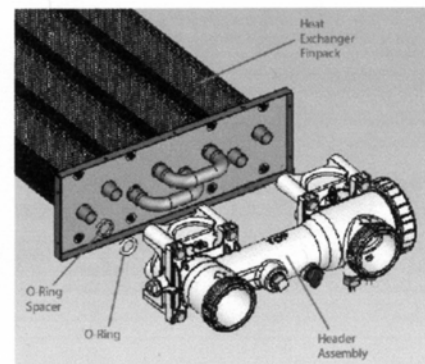
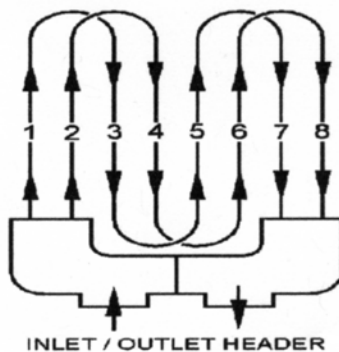

Natural Gas			Propane		
Description	Mfg No.	Item No.	Description	Mfg No.	Item No.
400 BTU Natural Gas	H400FDN	J2854	400 BTU Propane	H400FDP	J2864
350 BTU Natural Gas	H350FDN	J2852*	350 BTU Propane	H350FDP	J2862*
250 BTU Natural Gas	H250FDN	J2850*	250 BTU Propane	H250FDP	J2860*

*Non-Stock Item

**HAYWARD HEAT PUMP
POOL HEATERS**



*Transfers heat from outside air to pool water
providing energy efficient pool & spa heat*

HP 11002 Heat Pump

116,000 BTU J4715*

ITEM NO.

*Non-Stock Item

- Independent temperature controls for both pool & spa
- Accurate, reliable, one-touch temperature control
- Continuous pool temperature display
- Self-diagnostic codes for trouble shooting
- Compatible with Intermatic, AquaLink, Compool systems



RAYPAK HEAT PUMPS RHP SERIES

Single Phase, 208-230 Volt, 60 Cycle

PROFESSIONAL SERIES

*Features Scroll Compressor, Dual Thermostats, Titanium Heat Exchanger, Compact Cabinet.
PD Signifies "Power Defrost" - Will operate in temps. lower than 50 degrees to extend the season.*

				ITEM NO.
RHP 5100TI	Model# 010275	Wt. 325	100,000 BTU	J5050
RHP 6300TI-PD	Model# 011656	Wt. 325	115,000 BTU	J5052
RHP 6300TI	Model# 011656	Wt. 325	115,000 BTU	J5054
RHP 8300TI-PD	Model# 011657	Wt. 355	137,000 BTU	J5058

JANDY HEAT PUMPS

		ITEM NO.
AE2000T	Jandy Heat Pump 100,000 BTU Ti Heat Exchanger	J8020
AE2500T	Jandy Heat Pump 115,000 BTU Ti Heat Exchanger	J8022
AE3000T	Jandy Heat Pump 131,000 BTU Ti Heat Exchanger	J8024
AEREM	Digital Remote Control Panel Kit for Heat Pumps	J8030
AEREMKIT	Jandy Heat Pump Remote w/ Control Panel w/Actuator Valves	J8032
R3002000	2" PVC Union for Heat Pump Set of 2	J8031



COATES ELECTRIC SPA HEATERS

Compact electric spa heater with built-in flow switch which prevents operation when there is no water flow. Stainless steel tank optimizes heat transfer by directing the water flow over incoloy elements efficiently. Includes 1-1/2" x 2" union connections for PVC pipe



J1207

			ITEM NO.
1.44 KW	Coates Electric Heater	Model 1.5 ILS	J1202
5.5 KW	Coates Electric Heater	Model 12406 SHB	J1200
11 KW	Coates Electric Heater	Model 12411 ST	J1205
11 KW	Reconditioned	Model 12411	J1205R
5.75 KW	Coates Electric Heater - 240V	Model 6ILS	J1207



RAYPAK ELECTRIC SPA HEATERS



Raypak Electric Heater	5.5 KW	J1400
Raypak Electric Heater	11 KW	J1405

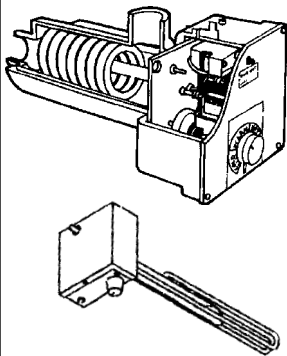

ELECTRIC SPA HEATER ASSEMBLIES

Brett Aqualine HT-1 Heater Assembly - 22-1BAQ-000-111 <i>1.5 KW 120 Volt & 6 KW 240 Volt Convertible</i>	M7100*
Element - 6 KW 220V w/ Studs	M7101*
Heater Housing, Black Plastic - Not Drilled	M7002*
5.5 KW - 240 Volt Electric Heater Assembly - (1" / 1-1/4") <i>Includes: Thermostat, Hi-Limit Switch & Indicator Light. Convertible to 1.375 KW 120 Volt</i>	J1299*
In-Line - 6KW 240 Volt, w/ T-Stat, Hi-Limit, P.S. & Contactor	J1291*
In-Line - 6KW 240 Volt	J1257+
In-Line - 1.5KW 120 Volt	J1250+

+Limited Stock
*Non-Stock

HEAT SINKS

Stainless Steel with PVC Union

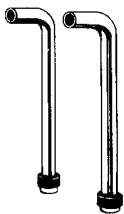

6" x 8" Elbow, Union & Adapters	J1302
6" x 17" Elbow, Union & Adapters	J1303
6" x 23" Elbow, Union & Adapters	J1306
6" x 26" Elbow, Union & Adapters	J1305
2" x 6" x 23", Elbow, Union & Adapters	J1309
2" x 6" x 20", Elbow, Union & Adapters	J1322

Copper with Male Adapter

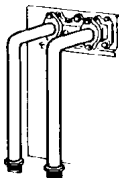

1-1/2" x 6" x 17" with 1-1/2" MTA	J1317
1-1/2" x 6" x 19" with 1-1/2" MTA	J1319
1-1/2" x 6" x 23" with 1-1/2" MTA	J1313
2" x 6" x 26" with 2" MTA	J1318
2" x 6" x 23" with 2" MTA	J1321

FIBERworks™ FIBER OPTIC LIGHTING

**Non-Stocked Items - Add Freight*



PG2000 Photon Generators - 7 Colors Standard

Fiber optic light source with 150 watt metal halide bulb that offers 6,000 hours of guaranteed life. All units include standard 7 colors & are auto control compatible. Wireless upgrade available.

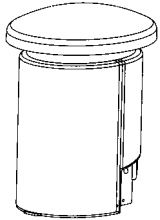

PG2000	#840240 Light Source - White Light Only	ITEM NO.	O1601*
PG2000	7 Color, Manual Switch, Auto Control Compatible		O1602
	RF2000 Wireless, Handheld Remote Control Upgrade		O1651
	RF2000 Wireless Remote Receiver Only		O1652*
	RF2000 Wireless Remote Transmitter Only		O1653*
	PG2000 90% Dimmer Window		O1654*

AmerGlow In Pool Lighting - Bulk Roll



Lens assembly complete for gunite, invisible gunite, vinyl or fiberglass, purchased separately. All Cable Special order - call for pricing - full roll or cut per foot

325	Fiber Cable - 250' Roll	(Yellow)*	
225	Fiber Cable - 250' Roll	(Purple)*	
170	Fiber Cable - 250' Roll	(Green)*	
325	Fiber Cable - 125' Roll	(Yellow)	O1619
70	Fiber Cable - 125' Roll	(Orange)*	



Optifusion Lenses, Housings & Termination System

Complete lens Assembly w/o housing	O1604
Lens Housing only for fiberglass	O1605
Complete Lens Assembly - Gunite Pools - Standard	O1617
Lens Housing Only - Gunite Pools - Standard 1-1/2"	O1620
Invisible Gunite Housing Only - 1-1/2"	O1627*
<i>(1" socket or fits inside 1-1/2" pipe)</i>	
Complete Lens Assembly - Vinyl Pools 1-1/2" FPT	O1690
Lens Housing Only - Vinyl Pools 1-1/2" FPT	O1639*
Professional Fiber Termination Kit	O1609
Color Wheel Motor	O1642



UltraGlow Perimeter Fiber Optic Cable - Bulk Roll*

UltraGlow	75 Fiber Cable	150'	O1661
UltraGlow	75 Fiber Cable	200'	O1662
UltraGlow	50 Fiber Cable	150'	O1682
UltraGlow	50 Fiber Cable	200'	O1683
UltraGlow	50 Fiber Cable	500'	O1684
UltraGlow	25 Fiber Cable	150'	O1673
UltraGlow	25 Fiber Cable	200'	O1674

Track Systems

"C" Track for Concrete Pools, White, 104'	O1607
"C" Track for Concrete Pools, Clear, 104'	O1641
"L" Track for Vinyl Pools, 104'	O1608

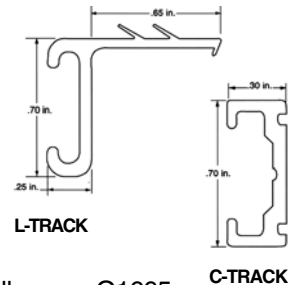

Replacement Lamps

Replacement Lamp for Fiberworks Photon Generator	220W Bulb	O1665
Replacement Lamp for PG2000 Metal Halide Illuminator	150W Bulb	O1745

***Non-Stock Item**



FIBER OPTIC LIGHTING SYSTEM



Polaris AfterDark Light Driver, 150W H.I.D. - 9 Color	ITEM NO. O5500
Polaris AfterDark Light Driver, 150W H.I.D. - No Color Wheel	O5510

Universal Fiber Lens

Universal Fiber Lens - Waterproof Lens Housing 1-1/2"	O5520
---	-------

Fiber Optic Cable, Pre-Cut (without lens)

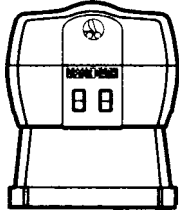

7 mm Fiber, 15' Long	(75 Strands)	AD715	O5556
7 mm Fiber, 30' Long	(75 Strands)	AD730	O5558
9 mm Fiber, 15' Long	(150 Strands)	AD915	O5564
9 mm Fiber, 30' Long	(150 Strands)	AD930	O5566
12 mm Fiber, 15' Long	(225 Strands)	AD1215	O5572
12 mm Fiber, 30' Long	(225 Strands)	AD1230	O5574
14 mm Fiber, 12' Long	(300 Strands)	AD1412	O5582
14 mm Fiber, 20' Long	(300 Strands)	AD1420	O5586

Accessories & Parts

Wireless Remote	AD15	O5516
Lamp Assembly	AD300	O5604
Lamp Only, 150W H.I.D.	AD305	O5606

**Most Items on this page are not stocked - Add Freight*



FIBER OPTIC LIGHTING SYSTEM

Wireless Remote System	RM-6004	O2010
Clear Finish FTG	FS-120	O2058
<i>for Perimeter Light 1" I.D. PVC</i>		
Acrylic Step Kit	FS-139	O2060
Star Glo Landscaping Fixture	SG-100	O2062
Fiberstix Landscape Fixture	FSTX-6	O2066
Bulk Fiber 12 Strd 250 Ft. Roll	B12-250	O2227
Bulk Fiber 12 Strd 125 Ft. Roll	B12-125	O2228
Bulk Fiber 25 Strd 250 Ft. Roll	B25-250	O2230
Bulk Fiber 75 Strd 250 Ft. Roll	B75-250	O2238
Lens Tightening Tool	FS-117	O2304
Lamp Assembly for 6000	Y20-6000	O2377

Luminator - With Metal Halide Light

Illuminator Model 6004AS w/ 450 Fiber Capacity	O2000*
Illuminator Model 6004 w/ 450 Fiber Capacity	O2002*

Luminator - With Quartz Halogen Light

Illuminator Model 2004AS w/ 410 Fiber Capacity	O2004*
Illuminator Model 2004 w/ 410 Fiber Capacity	O2008*

Perimeter Fiber

30 Strand Fiber-	150' Roll	O2264*
------------------	-----------	--------

Perimeter Mounting Tracks

Clear Track (Gunitite Pools)	50'/Box	O2051
White Track (Gunitite Pools)	50'/Box	O2050
White Track (Vinyl Pools)	100'/Box	O2053

Lens Housings & Misc. Accessories

Gunitite Lens Housing - 1-1/2"	LNS-2G	O2256*
Gunitite Insider lens Housing	LNS-2GI	O2258*
Vinyl Lens Housing - 1-1/2"	LNS-2V	O2259*
H.D. Hot Knife - 60 Watt	FS-118	O2300
RTV-400 Clear Silicone Adhesive		
10.3 Oz. Tube		O1266

Fiberglo Kits/Wall Fittings

Includes new sealed lens assy

75 Strand	15' Kit	O2219*
25 Strand	25' Kit	O2213*
150 Strand	14' Kit	O2201*
225 Strand	14' Kit	O2204*
225 Strand	18' Kit	O2206*
300 Strand	12' Kit	O2208*
300 Strand	18' Kit	O2210*

Replacement Lamps

Model HI-111 - 250 Watt	O2364
<i>24 Volt Halogen</i>	

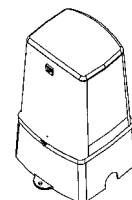

SPECTRUM AMERLITE (SAm) POOL LIGHT*Custom Mix of Light Color Spectrum*

Automated color lighting for pools & spas. Can synchronize multiple lights

**Pentair**
Pool Products™**120 Volt**

SAm Spectrum Amerlite 120 Volt w/30' Cord	O1845
SAm Spectrum Amerlite 120 Volt w/50' Cord	O1850
SAm Spectrum Amerlite 120 Volt w/100' Cord	O1860
SAm Spectrum Amerlite 120 Volt w/150' Cord	O1870
SAm Fountain Light 120 Volt w/50' cord	O1872
SAm Repair Kit #619481	O1804

12 Volt

SAm Spectrum Amerlite 12 Volt w/50' Cord	O1820
SAm Spectrum Amerlite 12 Volt w/100' Cord	O1830

SPECTRUM AQUALITE (SAL) SPA LIGHT*Automated Color Lighting for Spas***120 Volt**

SAL Spectrum Aqualite for Spas 120 Volt w/50' Cord	O1892
SAL Spectrum Aqualite for Spas 120 Volt w/100' Cord	O1894
SAL Spectrum Aqualite for Spas 120 Volt w/150' Cord	O1896

12 Volt

SAL Spectrum Aqualite for Spas 12 Volt w/15' Cord	O1886
SAL Spectrum Aqualite for Spas 12 Volt w/30' Cord	O1890
SAL Spectrum Aqualite for Spas 12 Volt w/50' Cord	O1888
SAL Spectrum Aqualite for Spas 12 Volt w/100' Cord	O1889

AQUA-LUMIN II NICHELESS LIGHT FOR POOLS & SPAS**120 Volt**

Nicheless Light 250 Watt 120 Volt w/50' Cord	O1203
Nicheless Light 250 Watt 120 Volt w/100' Cord	O1205

12 Volt

Nicheless Light 150 Watt 12 Volt w/50' Cord	O1113
Nicheless Light 150 Watt 12 Volt w/100' Cord	O1111

Complete Parts Breakdown on Page 438

**Mounting Brackets & Accessories**

Mounting Bracket for Vinyl Pools w/1" Hub	O1208
AquaLumin to AquaLumin II Retrofit Kit	O1207
Colored Lens Kit for AquaLumin II Pool Lights	O1117

PARAGON SLIMLITES

Paragon 500 Watt 120 Volt Slimlite w/26' Cord	O1065
Paragon 500 Watt 120 Volt Slimlite w/50' Cord	O1071

Need to replace a Paragon Light...Try Hayward Color Logic Lights-(They fit in the Paragon Niche) (Page 175)

AMERLITE POOL LIGHTS - Incandescent w/ S.S. Face Ring

120 Volt



	<i>ITEM NO.</i>
Amerlite 500 Watt 120 Volt Pool Light w/15' Cord	O1100
Amerlite 500 Watt 120 Volt Pool Light w/30' Cord	O1106
Amerlite 500 Watt 120 Volt Pool Light w/50' Cord	O1110
Amerlite 500 Watt 120 Volt Pool Light w/100' Cord	O1115
Amerlite 500 Watt 120 Volt Pool Light w/150' Cord	O1118
Amerlite 300 Watt 120 Volt Pool Light w/100' Cord	O1109

12 Volt



Amerlite 300 Watt 12 Volt Pool Light w/15' Cord	O1120
Amerlite 300 Watt 12 Volt Pool Light w/30' Cord	O1125
Amerlite 300 Watt 12 Volt Pool Light w/50' Cord	O1128
Amerlite 300 Watt 12 Volt Pool Light w/100' Cord	O1122



POOL NICHE

American S.S. Niche w/1" Hub for Concrete Pool	O1130
American S.S. Niche w/1" Hub for Liner Pool	O1135
American Plastic QuickNiche w/1" Hub for Concrete Pool	O1133
American Plastic QuickNiche w/1" Hub for Liner Pools	O1137

SPA BRITE SPA LIGHTS - Incandescent w/ S.S. Face Ring

120 Volt



Spa Brite Spa Light 100 Watt 120 Volt w/30' Cord	O1136
Spa Brite Spa Light 100 Watt 120 Volt w/50' Cord	O1142
Spa Brite Spa Light 100 Watt 120 Volt w/100' Cord	O1146

12 Volt

100 Watt 12 Volt Spa Light w/15' Cord - S.S. Ring	O1143
100 Watt 12 Volt Spa Light w/30' Cord - S.S. Ring	O1134
100 Watt 12 Volt Spa Light w/50' Cord - S.S. Ring	O1144
100 Watt 12 Volt Spa Light w/100' Cord - S.S. Ring	O1139

AQUALIGHT SPA LIGHTS - Halogen Quartz Lighting with S.S. Face Ring

120 Volt

Aqua-Light Spa Light 100 Watt 120 Volt w/50' Cord	O1138*
Aqua-Light Spa Light 100 Watt 120 Volt w/100' Cord	O6015*

12 Volt

Aqua-Light Spa Light 75 Watt 12 Volt w/100' Cord	O6035
--	-------

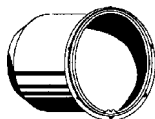

SPA NICHE

American S.S. Niche w/1" Top Hub for Concrete Spa	O1151
American S.S. Niche w/1" Rear Hub for Concrete Spa	O1670
Pentair S.S. Niche w/1" Rear Hub for Concrete Spa	O1880
American S.S. Niche w/1" Hub for Liner Spa	O1155
American Plastic Niche w/1" Hub for Concrete Spa	O1152
American Spa Brite/Aqua Light Lens Cover Set - 5 pcs.	O4083

*Non-Stock Item



HAYWARD POOL LIGHTS

AstroLite Series w/ Thermoplastic Face Rim

120 Volt



Hayward #583 AstroLite 500 Watt 120 Volt w/30' Cord	ITEM NO.	O1087
Hayward #583 AstroLite 500 Watt 120 Volt w/50' Cord		O1088
Hayward #583 AstroLite 500 Watt 120 Volt w/100' Cord		O1089
Hayward #572 DuraLite 300 Watt 120 Volt w/50' Cord		O1068+
Hayward #573 DuraLite 500 Watt 120 Volt w/50' Cord		O1043+
Hayward #573 DuraLite 500 Watt 120 Volt w/100' Cord		O1044+

12 Volt

Hayward #581 AstroLite 300 Watt 12 Volt w/15' Cord	O1021+
Hayward #581 AstroLite 300 Watt 12 Volt w/30' Cord	O1056
Hayward #581 AstroLite 300 Watt 12 Volt w/50' Cord	O1057
Hayward #581 AstroLite 300 Watt 12 Volt w/100' Cord	O1058

AstroLite Series w/ Stainless Steel Face Rim

120 Volt



Hayward #583 AstroLite 500 Watt 120 Volt w/50' Cord	O3010
Hayward #583 AstroLite 500 Watt 120 Volt w/100' Cord	O3020
Hayward #582 AstroLite 300 Watt 120 Volt w/100' Cord	O3038

Accessories

Select-a-Color Lens Kit for Hayward Lights	SP580L	O4012
Select-a-Color Lens Kit for StarLite Series Lights	SP540L	O1062+
Blue & Red Replacement Lens Cover Kit	SPX05090K	O1489

-Limited Stock

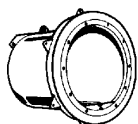

HAYWARD POOL NICHE

Hayward #600 PVC DuraNiche for Concrete Pools	O1023
Hayward #607 PVC DuraNiche for Vinyl Liner Pools	O1025

HAYWARD SPA LIGHTS

AstroLite II Series w/ Stainless Steel Face Rim

120 Volt



Hayward #591 AstroLite II Spa Light 100 Watt 120 Volt w/50' Cord	O3054
Hayward #591 AstroLite II Spa Light 100 Watt 120 Volt w/100' Cord	O3058

HAYWARD SPA NICHE

Hayward DuraNiche Fixture Housing for Spas	1" or 3/4" SKT	O1040
--	----------------	-------

PENTAIR SPA LIGHTS



Pac Fab 120V - 100 Watt Spa Light with 30' cord	O1368+
Pac Fab 12V - 100 Watt Spa Light with 100' cord	O1371+
Pac Fab 120 V - 100Watt Spa Light with 15' cord	O1370+
Fac Fab 120 V - 100Watt Spa Light with 50' cord	O1375+
Sta -Rite Small S.S. Niche 1" Hub for Concrete	O1372
Sta -Rite Small S.S. Niche 1"Universal PVC Gunite	O1373

-Limited Stock



Note: Niche for Color Logic Pool Light is O1023, Niche Color Logic Spa Light is O1040

HAYWARD COLOR LOGIC LIGHTS

Lights feature 12 preset programs - 5 fixed colors and 7 color changing shows!

****Hayward Color Logic Lights fit Paragon Niches****

	ITEM NO.
Hayward ColorLogic LED Light 120V - with 30' cord	O3015
Hayward ColorLogic LED Light 120V - with 50' cord	O3016
Hayward ColorLogic LED Light 120V - with 100' cord	O3012
Hayward ColorLogic LED Light 120V - with 150' cord	O3017
Hayward ColorLogic LED Light 12V - with 50' cord	O3011
Hayward ColorLogic LED Light 12V - with 50' cord and plastic rim	O3013
Hayward ColorLogic LED Light 12V - with 50' cord	O3014
Hayward ColorLogic LED SPA Light 120V - with 30' cord	O3021
Hayward ColorLogic LED SPA Light 120V - with 50' cord	O3022
Hayward ColorLogic LED SPA Light 120V - with 100' cord	O3023



JANDY COLOR POOL LIGHTS

Jandy Color Pool Lights 150 Watt 120V w/30' Cord	CPHV150WS30	O2400
Jandy Color Pool Lights 150 Watt 120V w/50' Cord	CPHV150WS50	O2402
Jandy Color Pool Lights 150 Watt 120V w/100' Cord	CPHV150WS100	O2404
Jandy Color Pool Lights 150 Watt 120V w/150' Cord	CPHV150WS150	O2405
Jandy Color Pool Lights 150 Watt 12V w/30' Cord	CPLV150WS30	O2410
Jandy Color Pool Lights 150 Watt 12V w/50' Cord	CPLV150WS50	O2412
Jandy Color Pool Lights 150 Watt 12V w/100' Cord	CPLV150WS100	O2414
Jandy Color Spa Lights 50 Watt 120V w/30' Cord	JSL12030	O2420
Jandy Color Spa Lights 50 Watt 120V w/50' Cord	JSL12050	O2422
Jandy Color Spa Lights 50 Watt 120V w/100' Cord	JSL120100	O2424
Jandy Color Spa Lights 50 Watt 12V w/30' Cord	JSL1230	O2430
Jandy Color Spa Lights 50 Watt 12V w/50' Cord	JSL1250	O2432
Jandy Color Spa Lights 50 Watt 12V w/100' Cord	JSL12100	O2434

Accessories:

Jandy Bulb Kit 25 W G-4		
Capsule 12V (2 bulb kit)	R0400300	O4000
Fiberstar Jazz Light - 4 Position Color Wheel w/100' Cord 120V		O3520

L.E.D. REPLACEMENT BULBS

Make extra profit and immediately transform pools and into a brilliant paradise.

Replace existing bulbs with L.E.D.



120 Volt Pool (88 LED)-	Medium Base Threaded	O3980
12 Volt Pool (88 LED)-	Medium Base Threaded	O3982
120 Volt Pool (88 LED)-	Reflective Bulb	O3983
12 Volt Pool (88 LED)-	Reflective Bulb	O3981
120 Volt Spa (22 LED)-	Medium Base Threaded	O3984
12 Volt Spa (22 LED)-	Medium Base Threaded	O3986
110 Volt Color Splash multi-Color (LED) Inground Pool		O4009
12 Volt Color Splash multi-Color (LED) Inground Pool		O4015
110 Volt Color Splash multi-Color (LED) Inground Spa		O4017
12 Volt Color Splash multi-Color (LED) Inground Spa		O4021

Jandy White Pool Lights

120 Volt - 500W Jandy White Pool Light w/100' Cord	WPHV500WP100	O2440
12 Volt - 300W Jandy White Pool Light w/100' Cord	WPLV300WP100	O2450
120 Volt - 100W Jandy White Spa Light w/100' Cord	WSHV100WP100	O2460
12 Volt - 100W Jandy White Spa Light w/100' Cord	WSLV100WP100	O2470
Jandy Plastic Pro Niche Large For Gunite	PLNICLRG	O2435
Jandy Plastic Pro Niche Small For Gunite	PLNICSM	O2436





SUNBRITE/SUNBRITE II POOL LIGHTS

Halogen Light w/ Stainless Steel Face Rim

120 Volt

	ITEM NO.
Sta-Rite SunBrite 500 Watt 120 Volt Pool Light w/15' Cord	O1010
Sta-Rite SunBrite II 300 Watt 120 Volt Pool Light w/30' Cord	O1399
Sta-Rite SunBrite 300 Watt 120 Volt Pool Light w/50' Cord	O1398
Sta-Rite SunBrite II 300 Watt 120 Volt Pool Light w/50' Cord	O1400



12 Volt

Sta-Rite SunBrite 200 Watt 12 Volt Pool Light w/15' Cord	O1018+
Sta-Rite SunBrite 200 Watt 12 Volt Pool Light w/30' Cord	O1019
Sta-Rite SunBrite II 200 Watt 12 Volt Pool Light w/30' Cord	O1017
Sta-Rite SunBrite 200 Watt 12 Volt Pool Light w/50' Cord	O1020+
Sta-Rite SunBrite II 200 Watt 12 Volt Pool Light w/50' Cord	O1022+
Sta-Rite Sunbrite 200 Watt 12 Volt Pool Light w/100' Cord	O1024



STA-RITE SUNLITE POOL LIGHTS

120 Volt

Sunlite 250 Watt 120 Volt Pool Light w/30' Cord	O1212
Sunlite 250 Watt 120 Volt Pool Light w/50' Cord	O1214
Sunlite 250 Watt 120 Volt Pool Light w/100' Cord	O1215



12 Volt

Sunlite 75 Watt 12 Volt Pool Light w/15 Ft Cord (05601-0497)	O1216
Sunlite 75 Watt 12 Volt Pool Light w/30' Cord	O1218
Sunlite 75 Watt 12 Volt Pool Light w/50' Cord	O1220
Sunlite 75 Watt 12 Volt Pool Light w/100' Cord	O1221

NICHES - SMALL

Small PVC Niche w/1" Hub for Concrete Pool	O1373
Small S.S. Niche w/1/2" Rear Hub for Concrete Pool	O1233+
Small S.S. Niche w/1" Side Hub for Concrete Pool	O1372
Small S.S. Niche w/1" Side Hub for Vinyl Liner Pool	O1228
Universal Adapter Ring 6811	O1231
Sunlite / Sunburst Snap-On Lens Color - Red	O1230
Sunlite / Sunburst Snap-On Lens Color - Blue	O1234

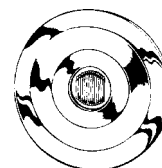

+ Limited Stock



STA-RITE SUNGLOW/SUNGLOW II POOL LIGHTS

120 Volt SunGlow II replaces SunGlow and SunBrite



	ITEM NO.
Sunglow S.S. 500 Watt 120 Volt Pool Light w/15' Cord	O1324+
Sunglow II S.S. 500 Watt 120 Volt Pool Light w/30' Cord	O1351
Sunglow S.S. 500 Watt 120 Volt Pool Light w/50' Cord	O1362
Sunglow II S.S. 500 Watt 120 Volt Pool Light w/50' Cord	O1352
Sunglow II S.S. 500 Watt 120 Volt Pool Light w/100' Cord	O1353
Sunglow II S.S. 300 Watt 120 Volt Pool Light w/100' Cord	O1359

12 Volt



Sunglow S.S. 300 Watt 12 Volt Pool Light w/15' Cord	O1322
Sunglow S.S. 300 Watt 12 Volt Pool Light w/30' Cord	O1355+
Sunglow II S.S. 300 Watt 12 Volt Pool Light w/30' Cord	O1354
Sunglow S.S. 300 Watt 12 Volt Pool Light w/50' Cord	O1357+
Sunglow II S.S. 300 Watt 12 Volt Pool Light w/50' Cord	O1361
Sunglow S.S. 300 Watt 12 Volt Pool Light w/100' Cord	O1356
Sunglow II S.S. 300 Watt 12 Volt Pool Light w/100' Cord	O1367

POOL NICHES

Large PVC Niche w/ ABS Trim Ring for Vinyl Pool w/1" Hub	O1378+
Large S.S. Niche (Sun Series) for Gunite Pool w/1" Hub	O1364
Large S.S. Niche w/ S.S. Trim Ring for Vinyl Pools w/1" Hub	O1366



SWIMQUIP POOL LIGHTS

120 Volt

Swimquip 500 Watt 120 Volt Pool Light w/25' Cord	O1085
Swimquip 500 Watt 120 Volt Pool Light w/50' Cord	O1090
Swimquip 500 Watt 120 Volt Pool Light w/100' Cord	O1091

12 Volt

Swimquip 300 Watt 12 Volt Pool Light w/25' Cord	O1097
Swimquip 300 Watt 12 Volt Pool Light w/50' Cord	O1099
Swimquip 300 Watt 12 Volt Pool Light w/100' Cord	O1096+



Colored Lens Kit for Swimquip Lights (Box of 3) O4095

GlowBuoy Floating Rechargeable Pool Light	O6030
GlowBuoy Colored Effects Lens (Set of 3)	O6031

LIGHT ADAPTOR RINGS

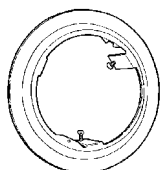

Universal Light Ring Adapter - <i>Used with Swimquip Lights</i>	O4195
500 Light Ring- <i>Used with Purex Lights</i>	O4100
500B Light Ring- <i>Used with Hayward Lights</i>	O4101
500C Light Ring- <i>Used with American Products Lights</i>	O4102
500P Light Ring- <i>Plastic Universal Ring for All Lights</i>	O4103
Adapter Light Ring Screws (Set of 3)	O4107

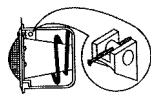

LIGHT WEDGE

Holds light in when niche tab is stripped or broken O4106



FLOOD (A)



SLIM (C)



HALO-GEN (F)



PUSH/TWIST (E)



BALL TYPE (B)

120 VOLT BULBS

	BULB TYPE	ITEM NO.
100 Watt Medium Base Flood	(A)	O4002
100 Watt American Spa Bulb	(A)	O5039
100 Watt Sunlite Halogen	(F)	O1319
100 Watt Sunlite Bulb	(E)	O1320
250 Watt Med. Base Halogen	(C)	O4028
250 Watt AquaLumin Halogen	(H)	O1201
250 Watt Sunlite - Push/ Twist	(E)	O1240
250 Watt Aqua-Light - Bayonet	(E)	O5066
250 Watt Aqua-Light - Screw-In	(F)	O5069
250 Watt Sunlite Bulb - Screw-In	(F)	O1241
300 Watt Sealed Beam	(D)	O4003
300 Watt Medium Base Flood	(A)	O4004
300 Watt Sunbrite/Sunsaver	(H)	O5134
400 Watt Medium Base Ball	(B)	O4005
500 Watt Medium Base Flood	(A)	O4010
500 Watt Sta-Rite Halogen	(H)	O1344

12 VOLT BULBS

25 Watt Jandy Bulb	(G)	O4000
50 Watt Funlite Halogen Bulb	(G)	O5067
60 Watt Sunstar Bulb	(G)	O1243
100 Watt 12V 2 Pin T3 GY 6.35		O5097
75 Watt Sunlite Bulb	(I)	O1238
75 Watt (SAm) Bulb 12V/120V Lights	(I)	O5075
100 Watt Hydrel T-4 Minicam	(F)	O1239
100 Watt Sunbrite/Sunsaver	(G)	O1342
100 Watt Medium Base Flood	(A)	O4020
100 Watt Med. Base - Am Prod	(A)	O5048
50 Watt 12V 50W w/Lens Fits Amer Illum.		O4037
150 Watt AquaLumin Bulb	(H)	O5059
300 Watt Sealed Beam	(D)	O4035
300 Watt Medium Base Flood	(A)	O4025
Bulb Adapter - Mogul to Med. Base		O4036

LIGHT LENSES

	ITEM NO.
4" Lens Clear - American Spa	O4088
7-9/16" Lens Clear - Purex/Hayward	O4040
8-3/8" Lens Clear - American	O4050
8-3/8" Lens Blue - American	O4055
Notched Lens Clear - Swimquip	O4060
Lens Clear - Aqua-Lumin	O5053
Light Lens Clear - S.R. Sunlite	O1248
Sunglow / Brite - Sta-Rite	O1750

LIGHT GASKETS

4" Gasket - American Spa	O5004
7-9/16" Gasket - Purex/Hayward	O4070
8-3/8" Lens Gasket - American	O4075
Notched Lens Gasket - Swimquip	O4080
Light Lens Gasket - S.R. Sunlite	O1246
Sunbrite/Sunglow Clamp Gasket	O1752

COLORED SNAP-ON LENSES

Light Lenses-Purex Snap-On	
7-9/16" Red	O4086
Light Lenses-Purex Snap-On	
7-9/16" Dark Blue	O4086
Box of 4 Lenses 8-3/8"	O4090
Box of 4 Lenses - AquaLumin	O1117
Box of 3 Lenses - Swimquip	O4095
Snap-on Lens 4" (Red)	O4092
Snap-on Lens 4"(Blue)	O4091
Pentair Luxury Lens -American (Blue)	O5080
Pentair Luxury Lens -American (Red)	O5082
Snap-on Lens 8-3/8" (Red)	O4094
Snap-on Lens 8-3/8" (Blue)	O4093
Snap-On Lens Sunlite (Red)	O1230
Snap-On Lens Sunlite (Blue)	O1234
Sta-Rite Colored Lens Cvr Lg (Blue)	O4097
Sta-Rite Colored Lens Cvr Lg (Red)	O4098
Parts Express GE912 Pack/2	J1821

Fits Sundance Spas



SEALED BEAM (D)



2-Prong (G)



QUARTZ (H)



HALOGEN (I)

TRANSFORMERS

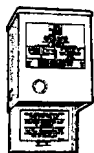

	ITEM NO.
Intermatic 100 Watt 12 Volt Transformer	O1161
Intermatic 300 Watt 12 Volt Transformer	O1160

ELECTRICAL ACCESSORIES

Junction Boxes

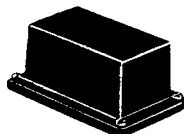

O1165

Pentair U.L. Lexan Junction Box w/ Brass Base 3/4" x 1" x 3/4" Taps	O1165
Hayward SP-681 U.L. Lexan Junction Box 1" x 1" x 1" Taps	O1166
PJB2175 Intermatic Junction Box - 2 Light Capacity	O1206
PJB4175 Intermatic Junction Box for Multiple Fixtures	O1167
Thermocraft Single Junction Box	O1169+

+Limited Stock

Flush Mount Junction Boxes

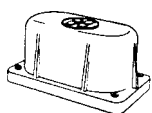

O1166

U.L. Chrome Deck Box w/ three 1" Taps (41192-2)	O1171
U.L. Chrome Deck Box 3/4" x 3/4" x 1" Taps (41192-1)	O1172
Chrome Cover for U.L. Deck Box (40166-0)	O1173

Conduit Sealing Compound (Sealer for leaking light conduit)

Leakmaster (Butyl Tape) "Light Conduit Sealer" - 15' Roll	O1197
---	-------

Potting Compound



Kit Sealing S.S. Niches	S4098
Aqua Bond AB-1000 Potting Compound 50 ml	S4099
Aqua Bond DM-50 Dispensing Gun for 50ml Cartridge (S4099)	S4100

Cord Stopper (Eliminates water leaks at pool light niche)

Niche Cord Stopper 3/4"	O1195
Niche Cord Stopper 1"	O1196

PVC CONDUIT & FITTINGS



1/2" Kaf-Flex Liquid Tight Straight Connector	O1162
1/2" Kaf Flex Liquid Tight 90 Degree Connector	O1163
3/4" Liquid Tight Straight Connector	O1174
3/4" 90 Degree Connector	O1176
1/2" x 100' Flexible Conduit	O1177
3/4" x 100' Flexible Conduit	O1178
1" x 50' Flexible Conduit	O1179
1" x 10' PVC Conduit	O1180
1/2" x 6' Kaf-Flex Conduit w/Wire & Fittings assembled GF-023	O1170
1/2" x 4' Kaf-Flex Conduit w/Wire & Fittings assembled GF-022	O1194
1/2" UL Male Adapter Sch. 40 Slip x MPT	O1181
1/2" UL Coupling Sch. 40 Slip x Slip	O1182
1" x 1/2" UL Reducer Bushing Sch. 40 Slip x Slip	O1183
1" x 3/4" UL Reducer Bushing Sch. 40 Slip x Slip	O1184
3/4" Sweep Elbow 90 Degree	O1185
3/4" Sweep Elbow 45 Degree	O1186
3/4" Terminal Adapter S x MP	O1187
3/4" U.L. Coupling	O1188
1" Sweep Elbow 90 Degree	O1190
1" Sweep Elbow 45 Degree	O1191
1" Terminal Adapter S x MPT	O1192
1" U.L. Coupling	O1193

WEATHERPROOF SAFETY ENCLOSURES



09000

09010

Intermatic Weatherproof Receptacle Cover	O4169
Raintite Enclosure - Standard Outlet Cover, Vertical Mount	O9000
Raintite Enclosure - Standard Outlet Cover, Horizontal Mount	O9010

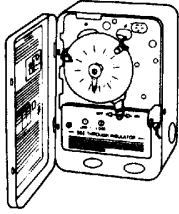

INTERMATIC TIMERS

Heavy duty mechanical time switches designed for commercial & residential applications.
Provides up to 12 "On/Off" operations each day with minimum On/Off times of 1 hour.

24 Hour Dial Time Switches

125 Volt Timer - Indoor	SPST (Metal Box)	T101	O4115
125 Volt Timer - Outdoor	SPST (Plastic Box)	T101P	O4120
125 Volt Timer - Outdoor	SPST (w/Heater Delay)	T101P201	O4125
120/240 Volt Timer - 1 Circuit Single Throw		T101C	O4117
250 Volt Timer - Indoor	DPST (Metal Box)	T104	O4130
250 Volt Timer - Outdoor	DPST (Plastic Box)	T104P	O4135
250 Volt Timer - Outdoor	DSST (w/Heater Delay)	T104P201	O4140
Dual Outdoor Timer (T104M201 & T104M)		T12404R	O4180
Pair of Dogs for Timer		156T1978A	O4155
Digital 3 Circuit Control		PE153	O4116
Multipurpose Digital Mechanism 120V or 208-240V		P1353ME	O4157
<i>Installs in any existing intermatic panel or enclosure.</i>			
<i>Controls variety of different applications - up to 20 amps</i>			
125 Volt Mechanism Only	SPST	T101M	O4160
125 Volt Mechanism Only	DPST	T103M	O4164
250 Volt Mechanism Only	DPST	T104M	O4165
125 Volt Mechanism Only w/Heater Delay		T101M201	O4170
250 Volt Mechanism Only w/Heater Delay		T104M201	O4175
208/277 Volt Timer - Outdoor - 2 speed		T106R	O4150
Motor Only	115 V	WG1570	O4172
Motor Only	208-277 V	WG1573	O4174
Heater Delay Kit		T201HD	O4178



Swimming Pool Control Center - 100 Amp

An all-in-one electrical control center which can be custom wired for a wide variety of requirements & eliminate the need for additional junction boxes & service panels.

240 Volt Electric Control Box with 2 Time Clocks	T32404R	O1200
100 Amps, Space for 8 Breakers		
120 Volt & 240 Volt Electric Control Box w 2 time Clocks	T30401R	O1202



INTERMATIC PORTABLE TIMER

Outdoor Timer in Plastic Enclosure	O4167
Great for Above Ground Pumps	



HAYWARD AUTO TIMER

Hayward Auto Timer with Cord & Mounting Bracket	H6079
Multiple Settings, Clear Cover & On/Off Switch. 15 Amp Rating	



SP0012T

PRECISION TIMERS

Precision Outdoor Timer 240V	CD104P-201	O4225+
Precision Timer 120V w/ Heater delay	CD101P201	O4210

~Limited Stock



WIRELESS AUTOMATED CONTROL SYSTEM

Complete system able to program or adjust all pool & spa functions, waterfalls, outdoor lighting & more. Easy to install in new or existing pools without drilling through walls or patios. Includes remote controller, charging base (freestanding or wall mountable), command center, two valves & two temperature sensors.

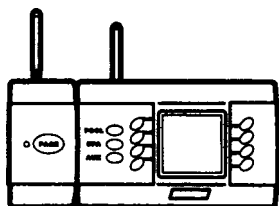

Polaris Sol 1000 Controller

with Electrical Subpanel

ITEM NO.
V8800+

Polaris Sol 1020 Controller

without Electrical Subpanel

V8805+

Polaris EOS Command Center Combo pool/Spa

V8806

Polaris EOS 4-Function Single Controller Pool/Spa

V8807



S-30 High Power Relay

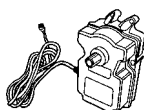

S-10 Actuator



S-50 Surge Protector



S-80 2-Speed Pump Relay

Parts & Accessories

Automatic Valve Actuator	S-10	V8850
Temperature Sensor w/ 15' Cable	S-20	V8852
High Power Relay	S-30	V8858
Battery w/ O-Ring & Gaskets, Remote	S-35	V8860
Surge Protection Module	S-50	V8866
Transformer	S-55	V8868
2-Speed Pump Relay	S-80	V8870

+Limited Stock

INTELLITOUCH POOL & SPA CONTROL SYSTEMS

Smart & Simple Pool Automation

A system for every application. Units available for the control of up to 40 pool, spa, landscape, & water feature functions all from simple on-screen menus.



Pentair

Pool Products™



IntelliTouch i5 Pool/Spa Combo

V4800*

IntelliTouch i7 + 3 Pool/Spa Combo

V4802*

IntelliTouch i9 + 3 Pool/Spa Combo

V4804*

Intellitouch i9+3 Personality Kit Pool/Spa Combo

V4805

Spa Side Remote iS-10

V4806*

Intellitouch MUD BOx for IS10 Remote

V4807

Indoor Panel for IntelliTouch - White

V4808*

IntelliTouch i10+3D Personality Kit-Dual Equipment

V4809

Load Center w/Breaker Base

V4810*

Power Center for IntelliTouch

V4812*

*Non Stock Items



Accessories

Relay, 3 HP	V4820
Relay, 2-Speed Pump	V4822

Compool Timer	V4743
---------------	-------

GOLDLINE WIRELESS CONTROL SYSTEM

AQL-PS-8 Aqua Logic Control w/ Sub Panel	D3006
AQL2-Base-RF Wireless Base	D3024
AQL2-Pod Wireless Handheld Remote	D3028
GVA-24 Valve Actuator (24 Volt)	D3030

JANDY WIRELESS AQUALINK CONTROL SYSTEMS

(PDA's Require Power Center)



PDA-P4	Pool or Spa Only	V5801
PDA-P8	Pool or Spa Only Aqualink RS	V5803
PDA-PS4	Pool & Spa Combo Aqualink RS	V5807
One Touch RS4	Sool & Spa Combo Aqualink RS	V5808
PDA-PS8	Pool & Spa Combo Aqualink RS	V5809
AQPLM	Aqua Palm Wireless Add On Remote	V5817



Not all Items Stocked



OneTouch Control Panel
4-1/2" x 4-1/2"

AQUALINK RS POOL & SPA DIGITAL CONTROLS

Digital controls for pool, spa, yard lights & other special effects such as waterfalls, fountains & fiber optic lighting. Completely programmable with the touch of a button. Telelink phone remote & other options available.



All Button Control Panel
8" x 5"

Pool & Spa Combination Sub Assemblies

For use with pool & spa combinations sharing one set of equipment
(1 pump, 1 filter, 1 heater & 2 three-port valves that switch between pool & spa)



		MFG	ITEM NO.
RS 4 (OneTouch)	Pool & Spa Control Center Sub Assy	#7955	V5808
RS 4 (All Button)	Pool & Spa Control Center Sub Assy	#6685	V4617
<i>Controls: Up to 4 Auxiliaries, Pool & Spa Thermostats</i>			
<i>Requires: 1 Power Center</i>			
RS 6 (OneTouch)	Pool & Spa Control Center Sub Assy	#7956	V5806
RS 6 (All Button)	Pool & Spa Control Center Sub Assy	#6686	V4612
<i>Controls: Up to 6 Auxiliaries, Pool & Spa Thermostats</i>			
<i>Requires: 1 Power Center</i>			
RS 8 (OneTouch)	Pool & Spa Control Center Sub Assy	#7957	V5804
RS 8 (All Button)	Pool & Spa Control Center Sub Assy	#6687	V4618
<i>Controls: Up to 8 Auxiliaries, Pool & Spa Thermostats</i>			
<i>Requires: 1 Power Center</i>			
RS 12 (OneTouch)	Pool & Spa Control Center Sub Assy	#7958RLY	V5812
<i>Controls: Up to 12 Auxiliaries, Pool & Spa Thermostats</i>			
<i>Requires: 2 Power Centers (Relays Included w/Assembly)</i>			
RS 16 (OneTouch)	Pool & Spa Control Center Sub Assy	#7959RLY	V5802
<i>Requires: 2 Power Centers (Relays Included w/Assembly)</i>			
RS 24 (OneTouch)	Pool & Spa Control w/ Relays	#7960	V5816
AquaSwitch	Pool & Spa Combo	#7300	V5840
<i>Includes Standard Power Center w/2 JVA's</i>			
Wireless RS8 Kit		#8225RLY	V5800
Jandy Purelink Sub Panel			V5811
<i>Includes Power Center 14 Blade</i>			
Jady Purelink Cell Kit			V5815
<i>Includes 14 Blade w/ 16' Cables 2" Unions, Sensor Tee & Sensor</i>			



Wireless V5800

Dual Equipment Sub Assemblies

For use w/ two separate sets of equipment (i.e. 2 pumps, 2 heaters & 2 filters for two separate bodies of water)

RS 2/6 (All Button)	Dual Equipment Pool & Spa Sub Assy	#6691	V4638
<i>Controls: Pool Pump, Spa Pump, 6 Aux., Pool Heater, Spa Heater & Solar</i>			
<i>Requires: 1 Power Center</i>			
RS2/10 (OneTouch)	Dual Equipment Control w/Relays	#7970RLY	V5836
<i>Controls: Pool Pump, Spa Pump, 10 Aux., Pool Heater, Spa Heater & Solar</i>			
<i>Requires: 2 Power Centers (Relays Included w/Assembly)</i>			

Power Centers

Standard Power Center for RS Controls	#6613	V4614
Sub Panel Power Center for RS Controls	#6614	V4613

Sub Panel Power Center #6614

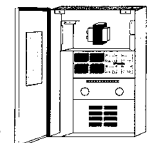



AQUALINK RS CONTROLS & ACCESSORIES

Pool Only / Spa Only Controls

For use with pool only or spa only system (1 body of water) using one set of equipment

	MFG NO.	ITEM NO.
RS 4 (All Button) Pool Only / Spa Only Control Center Sub Assy <i>Controls: Up to 4 Auxiliaries</i> <i>Requires: 1 Power Center</i>	#6688	V4617SP
RS 6 (All Button) Pool Only / Spa Only Control Center Sub Assy <i>Controls: Up to 6 Auxiliaries</i> <i>Requires: 1 Power Center</i>	#6689RLY	V4612SP
RS 8 (All Button) Pool Only / Spa Only Control Center Sub Assy <i>Controls: Up to 8 Auxiliaries</i> <i>Requires: 1 Power Center</i>	#6690RLY	V4618SP
PCB (White Button) Pool Only / Spa Only Control Center Sub Assy	#RO550700	J5931

Parts & Accessories

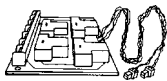

Relay Module #3652

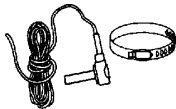

Temperature Sensor Kit

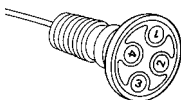

4-Function Remote Switch



Flush Mount Mud Box #7940

Relay (3 HP) with Harness for "RS"	#R0658100	V4616
Relay Kit (2-Speed Motor) with Bracket	#6796	V4615
Relay Kit (Light Dimming)	#6587	V4619
Relay Module PCB Complete (JI Series)	#3652	V4583
Relay Board Module for 2-Speed Pump	#4663	V5908
Auxiliary/JVA Relay Complete (All Systems)	#5254	V4610
Actuator JVA2440	#4424	V4578
Dual Spa Side Switch Kit for AquaLink/RS	#6588	V5865
Temperature Sensor Kit 15' (Water, Air, Solar)	#7790	V4645
Temperature Sensor Kit 50' (Water, Air, Solar)	#7786	V4646
Temperature Sensor Kit 125' (Water, Air, Solar)	#7791	V4648
4-Conductor Cable for RS Controls - Per Foot	#4278	V4640
9-Pair Cable - Per Foot	#1899	V4586
Surge Protection Kit, Std (1 High & 2 Low Volt)	#6908	V4647
Surge Protection Kit (for RS12, 16/2/10, 2/14)	#7627	V4655
Freeze Sensor Kit	#7026	V5845
24Hour Time Clock for AquaLink RS	#7152	V5847
7 Day Time Clock Kit	#4635	V4636
24 Hour Time Clock Kit	#4634	V4637
Conversion Kit (Ji8000/AquaLink to RS 8)	#7092	V4643
Decal Set for AquaLink RS Auxiliary Equipment	#6781	V5856
Decal Set for AquaSwitch Faceplate	#7312	V5857
4-Function Remote Switch w/ 50' Cable - White	#4304	V4605
4-Function Remote Switch w/ 100' Cable - White	#3971/7441	V4584
4-Function Remote Switch w/ 150' Cable - White	#4137/7443	V4585
4-Function Remote Switch w/ 100' Cable - Gray	#8049	V4581
4-Function Remote Switch w/ 150' Cable - Gray	#8050	V4582
4-Function Remote Switch w/ 200' Cable - Gray	#8051	V4635
4-Function Remote Switch w/ 50' Cable - Gray	#8050	V4587
Spa Link RS 8-Function Spa Side Remote w/ 150' Cord	#7227	V5843
Spa Link RS 8-Function Spa Side Remote w/ 200' Cord	#7489	V5844
Spa Link RS Flush Mount .Mud Box	#7940	V5848
Transformer (Power Center) 120V, 24V	#6612	V5935
Telelink Kit for RS (Includes Junction Box)	#6590	V4639
Multiplex PCB Kit	#6584	V5940
PCB Repair Kit RS Power Center without PPD Chip	#8194	V5929
RS8 (Pool & Spa Combo) Upgrade Kit	#6729	V5930
RS6 (Pool & Spa Combo) Indoor Control Panel	#6888	V5861
RS8 (Pool & Spa Combo) Indoor Control Panel	#6886	V5860
RS8 (Pool Only or Spa Only) Indoor Control Panel	#6887	V5832
RS12 (Pool & Spa Combo) Indoor Control Panel	#7346	V5859
One Touch Indoor Control Panel	#7953	V5810

LEN GORDON SPA CONTROLS

Len Gordon FF-1094 series offer a simple & reliable four function control for any two pieces of equipment with one air button up to 150 feet away.



- | | | |
|---|---|-------------------|
| FF-1094 | Complete Four Function Spa Control | ITEM NO.
M2002 |
| <i>One button sequences any two pieces of equipment. Controls single or 2-speed pump & blower.</i> | | |
| <i>External time clock adaptable. 20/240V, 20 Amp, 1 to 2 HP (Neutral required)</i> | | |
| FF1094TC | Complete Four Function Spa Control w/ Time Clock | M2003 |
| <i>Same as the basic FF-1094, but with a built-in 24-hour time clock.</i> | | |
| <i>120/240V, 20 Amp, 1 to 2 HP (Neutral required)</i> | | |
| FF1094LTC | Complete Four Function Spa Control | M2005 |
| <i>Same as above FF-1094TC plus an auxiliary circuit. Second button required to operate third piece of equipment. 120/240V, 20 Amp, 1 to 2 HP</i> | | |

Freeze Control

- | | | |
|---|-----------------------------------|-------|
| FC-5SS-95 | 120V w/ Pre-Set Thermostat | M2012 |
| <i>Adjustable set point from 32 to 100 degrees with solid state thermostat.</i> | | |
| <i>120/240V, 20 Amp, 1 to 2 HP (Adaptable to 240V if neutral is supplied)</i> | | |

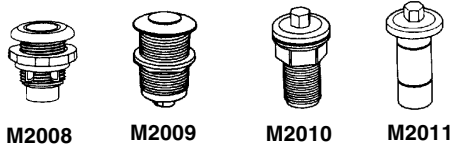

Air Button

- | | | |
|---------------------------|---------|-------|
| #4 for Fiberglass & Liner | - White | M2010 |
| #4 for Gunite | - White | M2011 |
| #10 Smooth | - White | M2008 |
| #15 Classic Touch | - White | M2009 |

TWO FUNCTION SPA CONTROLS

- | | | |
|--|---|-------|
| AS-MULTI COMBO | Premium On/Off Spa Control. Time Clock Adaptable | M2048 |
| <i>Operates single piece of equipment. Will control single or 2-speed pump. 120/240V, 20 Amp. (Button not included)</i> | | |
| ES-COMBO | Economy On/Off Spa Control. 120/240V, 20 Amp, 1 to 2 HP. | M2049 |
| <i>Operates single piece of equipment. Maximum air tubing distance is 35 Ft. Must use either #10 or #15 Button (Not Included).</i> | | |
| | Air Switch 240 V | M2050 |

AQUA-SET SPA SIDE CONTROLS

Deck control w/ solid-state thermostat & sensing probe. Adaptable to most spa packs. Price includes faceplate.

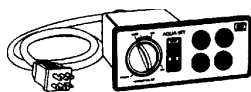

- | | | | | |
|---|------|---------|------------|-------|
| Aqua-Set 2-Button Control | 120V | 6' Cord | 2001-2SS | M2057 |
| Aqua-Set 3-Button Control | 120V | 6' Cord | 930736-516 | M2061 |
| Aqua-Set 4-Button Control | 120V | 6' Cord | 4001-4SS | M2064 |
| Face Plate Only for Aqua-Set 2-Button Control | | | | M2060 |
| Face Plate Only for Aqua-Set 3-Button Control | | | | M2062 |
| Face Plate Only for Aqua-Set 4-Button Control | | | | M2065 |

Accessories & Parts

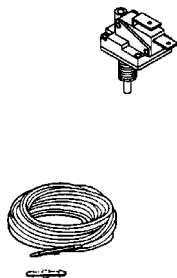

- | | | |
|--|-----------------------------|--------|
| Relay S87R 120V S.P.S.T. | 410120 | M2205 |
| Relay S90R-5ABDI-120V S.P.D.T. | 410122 | M2207 |
| Relay S90R-11ABD1-120V D.P.D.T. | 410123 | M2208 |
| Relay S87R 240V D.P.S.T. | 410241 | M2213 |
| Jag-3 Air Sensor - Momentary contact pilot duty, S.P.S.T | | M2051 |
| Jag-3 Water Level Sensor 3 Amp | | M2235 |
| Drywell Assembly - Plastic with Grommet | <i>Fits 5/16" x 4" Bulb</i> | 990180 |
| Tubing Couplers | | M2014 |
| Tubing Tee | | M2015 |
| Tubing 1/8" ID x 20' | | M2016 |
| Time Clock Trippers | | M2013 |

PRES-AIR CONTROLS

- | | | |
|--|------------|-------|
| Pres Box w/4-function Air Switch PB-4 (Blue) | PBMTB3111A | M2100 |
| On-Off Switch (120 Volts- 21 Amps) | ARA111A | M2071 |
| On-Off Switch (240Volts- 21 Amps) | ARA211A | M2075 |
| 4-function Switch (21 Amp - 110/220 | MCG-311A | M2076 |
| Soft Actuator Panel Mount - White | B142WA | M2085 |

PROPAK

by gecko electronics inc.

Net Price - Non Stocked Items - Add Freight

DIGITAL SPA PACK

Specifically Designed for Retrofit Applications

For spas with single pump, dual pump or one pump and one blower configurations, a heater, an ozone generator and a mood light

- 120V/240V Compatibility
- Automatic Time-Out on all Outputs
- Digital Temperature Display
- Sensor Failure Detection
- High Limit Protection
- Programmable Filtering Cycles



Propak "S" Series Retrofit Spa Pack w/Amp Connectors
Old #0202-207004 - New #3-72-7078

Propak "S" Series Retrofit Spa Pack w/ J&J Connectors
Old #0202-207005 - New #3-72-7079

ITEM NO.
M4000+

M4002+

Units Contain Outputs For:

- One Dual-Speed 120V or 240 V Pump
- One Single-Speed 120V or 240V Pump or Blower
- 120V or 240V Ozonator
- 12V Light Socket

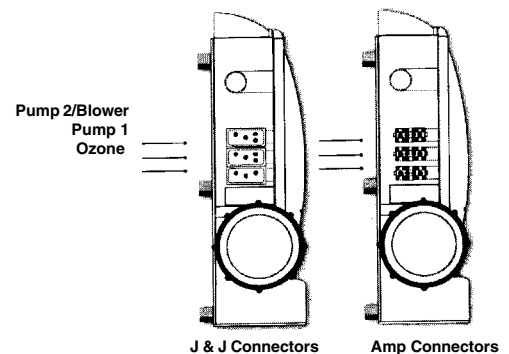

Top Side Keypad TSC-18 M4010+
2-1/2" x 5"

Top Side Keypad TSC-19 M4012+
2-1/4" x 7"

Quick Plug & Wire Assembly M4018+

White Wet-End Fitting for Temperature Probe - Clear M4020+

J & J Cable Kit for "S" Series Pack M4016+

+Limited Stock



HYDROQUIP ES-9000-U SERIES EQUIPMENT PACK

Ideal for Retro-Fit Use

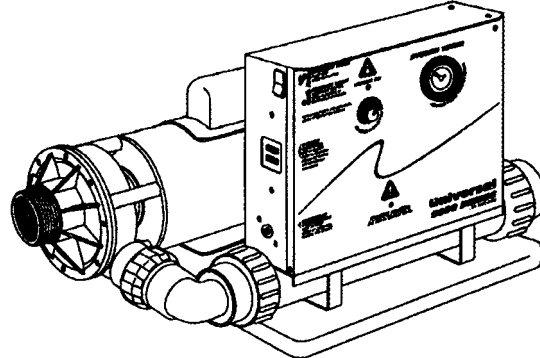

*NET PRICE
Non-Stock Items
F.O.B. Corona, CA.

Overall Specifications

Length 22-1/2"
Height 16-1/4"
Depth 14"

Standard Product Features

- * Small Compact Size
- * Full Rated Pump Horsepower
- * Full Rated Air Blower Horsepower
- * 12 Volt Light with 96" Lead
- * Light Fitting with Lenses
- * Spaside Control Receptacle
- * Spaside Drywell Provided
- * Plug Connected Components
- * Universal Ozone Circuit with 48" Cord
- * 24 hour Timer with Mode Switch
- * Air Buttons & Tubing
- * Full Range Thermostat
- * Heater ON Light
- * High Limit Protected Heater
- * 1.4 KW 120V Heater Operation
- * 5.5 KW 240V Heater Operation
- * Stainless Steel Heater Housing
- * Corrosion Resistant Plastic Base
- * Pressure Switch Controlled Heater
- * Heater Disconnect Unions
- * Detailed Operation Manual
- * UL & ETL Recognized
- * Mis-Wire Protection Circuit
- * 3-Year Heating Element Warranty
- * 2-Year Parts & 1-Year Labor Warranty

ORDER CODE	SUPPLY VOLTAGE	PUMP SIZE	PUMP1 VOLTAGE	BLOWER CIRCUIT	LIGHT CIRCUIT	PUMP2 OPTION	ITEM NO.
ES-9000-A-U	120/240V	1 HP	120V	w/1 HP Blower	12V	120/240V	M3000
ES-9000-B-U	120/240V	1 HP	120V	120/240V Ready*	12V	120/240V	M3002
ES-9000-C-U	120/240V	1-1/2 HP	120V	w/1 HP Blower	12V	120/240V	*
ES-9000-C-5-U	240V	1-1/2 HP	240V	w/1 HP Blower	12V	120/240V	*
ES-9000-D-U	120/240V	1-1/2 HP	120V	120/240V Ready*	12V	120/240V	*
ES-9000-D-5-U	240V	1-1/2 HP	240V	120/240V Ready*	12V	120/240V	*
ES-9000-E-U	240V	2 HP	240V	w/1 HP Blower	12V	120/240V	*
ES-9000-F-U	240V	2 HP	240V	120/240V Ready*	12V	120/240V	M3014
ES-9000-G-U	240V	3 HP	240V	w/1 HP Blower	12V	120/240V	*
ES-9000-H-U	240V	3 HP	240V	120/240V Ready*	12V	120/240V	*
ES-9000-J-U	240V	4 HP	240V	w/1 HP Blower	12V	120/240V	*
ES-9000-K-U	240V	4 HP	240V	120/240V Ready*	12V	120/240V	*

(*Air Blower Ready - Not Included)

*Special Order Only - Non-Stocked Items

Units without GFCI installed may require a 20 Amp corded GFCI for 120 Volt operation or a GFCI circuit breaker for 240 Volt operation.

Factory Installed Options (Add to Above Price)

- 240V Single Speed - 2nd Pump Circuit
 - 240V High Current GFCI (NEC & UL Approved)
 - 2nd Pump Circuit & High Current GFCI
- (See page 169 & 190 for Spa Heaters and Heater elements)

ANZEN AIR BLOWERS

Bottom Mounted Blowers

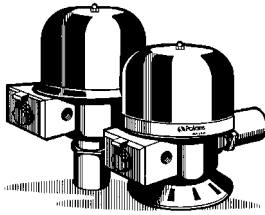

			ITEM NO.
1 HP	120 Volt	6.4 Amps	M1010
1 HP	240 Volt	3.2 Amps	M1012
1-1/2 HP	120 Volt	7.8 Amps	M1015
1-1/2 HP	240 Volt	3.9 Amps	M1017
2 HP	120 Volt	8.8 Amps	M1020
2 HP	240 Volt	3.9 Amps	M1022

Side Mounted Blowers



1 HP	120 Volt	M1150
1 HP	240 Volt	M1152
1-1/2 HP	120 Volt	M1154
1-1/2 HP	240 Volt	M1156
2 HP	120 Volt	M1158
2 HP	240 Volt	M1160

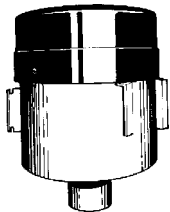

QT Series Blowers

1 HP	120 Volt	M1034
1 HP	240 Volt	M1035
1-1/2 HP	120 Volt	M1031
1-1/2 HP	240 Volt	M1030
2 HP	120 Volt	M1033
2 HP	240 Volt	M1032



Replacement Motors

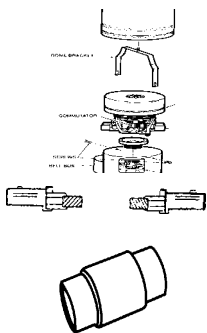

1 HP	Blower Replacement Motor 110V	M1009
1-1/2 HP	Blower Replacement Motor 110V	M1027
2 HP	Blower Replacement Motor 110V	M1029
1 HP	Blower Replacement Motor 220V	M1180
1-1/2 HP	Blower Replacement Motor 220V	M1182
2 HP	Blower Replacement Motor 220V	M1184
	Anzen Motor Brush Kit	M1171
	Check Valve for Air Blower 2" OD x 1-1/2" Slip	M1044

COMMERCIAL SPA BLOWERS

Rugged, direct-drive (no belts) blowers rated for continuous use in hotels, motels & health clubs. Each model features premium efficient motors w/long life bearings.

Duralast

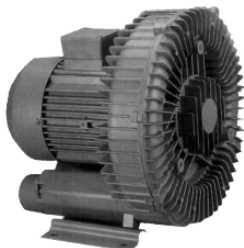

1 HP	Commercial Spa Blower	240V (DR404AQ58M)	M2018*
1-1/2 HP	Commercial Spa Blower	240V (DR454V58)	M2024*
2 HP	Commercial Spa Blower	240V (DR505AW58M)	M2019*
3 HP	1 Phase Com. Spa Blower	115/230V (DR555K58)	M2022*

*Non-Stock Item

***FREIGHT CHARGES ARE NOT INCLUDED - F.O.B. Factory**
Other Sizes & Voltages Available

SPA WANDS

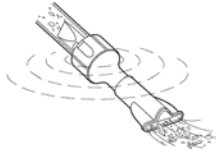

Polaris Spa Wand (Blue Consumer Model)
 Polaris Spa Wand (Blue Consumer Model)
 Polaris Spa Wand PRO (Yellow Professional Model)
 Polaris Spa Wand PRO XL (Extended Professional Length)
 Polaris Filter Screen Replacement

ITEM NO.
 M5394
 M5395
 M5398+
 M5410
 M5406

Spa & Pool Vacuum by Game (Spa Wand Style)
 Rola-Chem Spa Vac- Clear Model

B2011+
 M5460

+Limited Stock

FOAM SPA BLANKET

Deluxe Floating Spa Cover. Made of Foam

6' x 6'	M5502+
8' x 6'	M5500+
8' x 7'	M5501 Obsolete
8' x 8'	M5503+
10' x 9'	M5506 Obsolete
9' x 12'	M5507 Obsolete

+Limited Stock

SCUM REMOVERS



Scumbag 1/Ea	M5393
Scumball 2/Bag	M5397
Scumbrush 1/Ea	M5403
Scummitt 1/Ea	M5404+
Bug Solution "Bugmitt"	M5430
Bug Solutions "Algae Buzzer"	M5436



+Limited Stock

SPA PILLOWS

Super Soft Weighted - White	M5383
Super Soft Weighted - Blue	M5382
Super Soft Weighted - Teal	M5381
Super Soft Weighted - Grey	M5384
Super Soft Suction Cups - Blue	M5386

SPA RAILS

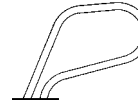

Spa Rail - S.S. G7069
 w/Welded Bottom Plate

STOP LEAK & TUB OF GOLD

Fix-A-Leak - 32 Oz. Bottle	M5379
Stop Leak - 32 Oz. Bottle	M5380
Tub of Gold- 5 Lbs.	M5385

SPA PADS

50" x 50" x 3" H8098
 Sized For Up To 8' Spas

DELUXE SPA COVERS

*Made with high density 2 Lb. foam in 2-panel bi-fold or 4-panel quad fold construction.
 Standard covers have 4" to 2" tapered slope thickness with a 2-1/2" flap.
 Comes with 2 carrying handles and 4" locks.*

**Standard Colors: Almond, Black, Brown, Burgundy, Charcoal,
 Med & Lt. Grey, Navy & Sky Blue, Tan & Teal & Forest Green**

***Deluxe Spa Cover - Bi-Fold (96" or Less)
 *Deluxe Spa Cover - Quad-Fold (Over 96")**

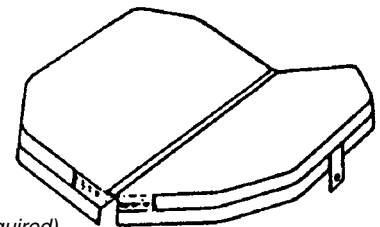

**AVAILABLE BY SPECIAL ORDER ONLY.
 FREIGHT CHARGES ARE NOT INCLUDED - F.O.B. PLANT (Deposit Required)
 (Allow approximately 2 week lead time for delivery)*

SPA FITTINGS

		ITEM NO.	
		2100	M5080
		2100	M5081
		46950020	M1546
		2200	M5100
		2200	M5101
		2310	M5316
		3808	M5000
		3100	M5020
		3100	M5021
		3100	M5022
		3100	M5023
		3100	M5024
		3801	M5330
		3300	M5040
		3803	M5200
		3804	M5340
		5847	M5225
		4100	M5060
		5030	M5710
		5031	M5712
		3830	M6000
		4100	M5070
		4401	M5072
		5275	M5310
		6201	M5140
		6011	M5210
		5200	M5312
		6800	M5110
		6800	M5111
		6830	M5120
		6900	M5105
		5759	M5063
		7831M	M5300
		7825	M5301
		1434	N1063
			N1442
			N1061
			N1191
			N1059
			N1173
			N1194*
			N1067
		1434T	N1068
		C20E	N1065
			M1610
			M1611
			M1613
			M1615
			M1617
			M1618
			M1621
			M1623
			M1670
			M5701

Heater Replacement Elements

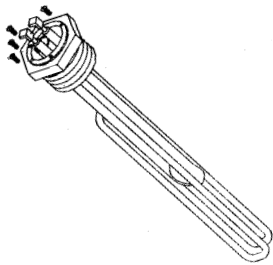

		PART NO.	ITEM NO.
Brett	6 KW 5" Square Flange w/Studs	12-0001	M7101
Brett	6 KW 5" Square Flange 2 Wells	42-1008	M5261
Hydro-Quip	6 KW 5" x 9" Rec. Flange 2 Wells	42-1009	M5262
Various	6 KW Flo-Thru 11-1/4" Long	41-1016	M5263
	1.5 KW 1-1/4" 2 Wells	41-1004	M5264
	6 KW 1-1/4" 2 Wells	41-1015	M5265
	1.5 KW 1" MPT x 7" 0 Wells	41-1002	M5258
	6 KW 1" MPT x 8" 0 Wells	41-1012	M5259
	1.5 KW/120V 1" MPT x 2 Wells		J1264
	6 KW/240V 1" MPT x 2 Wells		J1263
	Flange Adapter 2-3/4 Flange x 1" FPT		J1265
	Brass Adapter 1-1/4 x 1"		J1266

Thermostats

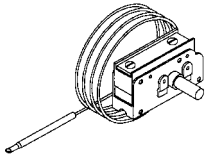

Eaton	12" Cap 3.70" Bulb x 1/4" Dia.	55-1003	M5274
Eaton	36" Cap 3.70" Bulb x 1/4" Dia.	55-1005	M5275
Eaton	60" Cap 3.70" Bulb x 1/4" Dia.	55-1001	J1277
Eaton	12" Cap 3.40" Bulb x 5/16" Dia.	55-1004	M5276
Eaton	36" Cap 3.40" Bulb x 5/16" Dia.	55-1006	M5277
Eaton	48" Cap 4.07" Bulb x 5/16" Dia.	55-1007	M5296

High Limits

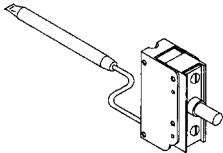

Eaton	12" Cap 3.36" Bulb x 1/4" Dia.	50-1001	M5278
Eaton	18" Cap 2.50" Bulb x 5/16" Dia.	50-1004	M5279
Eaton	36" Cap 3.36" Bulb x 1/4" Dia.	50-1002	M5281
Eaton	6" Cap 3.00" Bulb x 5/16" Dia.	50-1003	M5282
Eaton	Thermo Disc 50 AMP 2 Pole	50-1006	J1278

Pressure/ Flow Switches

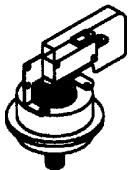

Tri-Delta	25A Barb	70-1003	J1275
Tri-Delta	SPST 25A 1/8" NPT	70-1004	J1276
Len Gordon	SPST 25A 1/8" NPT	70-1012	M5286+
Len Gordon	SPDT 20A 1/8" NPT (w/ Barb & Comp. ftg.)	8000120	M5552
Len Gordon	SPST 25A Barbed	70-1013	M5287
Aladdin	Universal Pressure Switch 1-5 PSI	80-3902	M5194
Parts Express	Flow Switch 1/2" MPT	60-1008	M5554
Grid Controls	25A 1-1/2" SKT Flow Switch	60-1007	M5288

+Limited Stock

Relays & Contactors

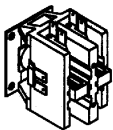

Potter Brumfield	DP 30A 120V Coil	35-1009	M5290
Potter Brumfield	DP 30A 240V Coil	35-1010	M5291
Joslyn Clark	SP 30A 120V Coil	35-1035	M5293
Joslyn Clark	DP 30A 120V Coil	35-1004	M5292
Joslyn Clark	30A 240V Coil	35-1036	J1273

Time Clocks

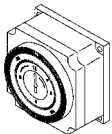

Grasslin	24 Hour 120V	80-1007	M5294
Diehl	7 Day 120V	80-1015	M5295
Diehl	24 Hour 120V	80-1014	M5297
Diehl	7 Day 220V	80-1013	M5298
Diehl	24 Hour 220V	80-1012	M5299

Air Switches

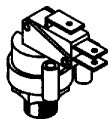

Tridelta	1 HP/ 120V - 2 HP/ 240V	TBS-301	M5183
Tridelta	1/10 HP 120/ 240 V	TBS-312	M5184
Tridelta	1 HP/ 120V - 2 HP/ 240V SPDT	TBS-901	M5186
Tridelta	1 HP/ 120V - 2 HP/ 240V (Repl. TBS-213)	TBS-917	M5185
Tridelta	4-Function Sequence Switch - 120V	CSC-1131	M5188
Tridelta	4-Function Air Switch (Replaces SAS-105)	SAS-101	M5189

Thermowell

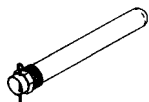

Aladdin	PVC Accepts 5/16" OD x 4-1/8" Bulb	AM-3518	M5187
---------	------------------------------------	---------	-------

EYEBALL FITTINGS

1-1/2" MPT Threaded

	ITEM NO.
1-1/2" MPT Eyeball Fitting w/ 3/8" Opening 	N1008
1-1/2" MPT Eyeball Fitting w/ 1/2" Opening 	N1010
1-1/2" MPT Eyeball Fitting w/ 3/4" Opening 	N1011
1-1/2" MPT Eyeball Fitting w/ 1" Opening 	N1012
1-1/2" MPT Eyeball Fitting w/ Slotted Opening 	N1009
1-1/2" MPT Eyeball Fitting w/ Rubber Nozzle 	N1027

Black Threaded Eyeball Fittings

	ITEM NO.
Black Eyeball Waterway Fitting 400-1411DB 1-1/2" w/ 3/4" opening	N1071
Black Eyeball Waterway Fitting 400-1411EB 1-1/2" w/ 1" opening	N1096
Black Threaded Eyeball Fitting 1-1/2" MPT w/ 1/2" Opening #540015	N1028
Black Threaded Eyeball Fitting 1-1/2" MPT w/ 3/4" Opening #540022	N1016
Black Threaded Eyeball Fitting 1-1/2" MPT w/ 1" Opening #540029	N1015
Black Threaded Eyeball Fitting 1-1/2" MPT w/ Slotted Opening #54001	N1014

1-1/2" MPT Extended Flange

1-1/2" MPT Extended Flange Eyeball Fitting w/ 3/4" Opening 	N1001
--	-------

Black Insider - Fits Inside 1-1/2" Pipe

Black Insider Eyeball Fitting w/ 3/4" Opening	N1022
Black Insider Eyeball Fitting w/ Lock Ridge Aquadapter 	N1204
Black Waterway Insert Eyeball 400-1421E w/ 1" opening	N1192



Insider w/ Extended Flange

1-1/2" Insider Eyeball Fitting w/ 3/4" Opening & Extended Flange 	N1003
1-1/2" Insider Eyeball Fitting w/ 1" Opening & Extended Flange	N1004

Dk Gray /Gray Insider- Fits Inside 1-1/2" Pipe

Gray Insider Eyeball Fitting w/ 3/4" Opening #400-1427D	N1041
Gray Insider Eyeball Fitting w/ 1" Opening #400-1427E 	N1044
Dark Gray Waterway Insert Eyeball 400-1429E-DK w/ 1" opening	N1199

Insider - Fits Inside 1-1/2" Pipe

1-1/2" Insider Eyeball Fitting w/ 3/4" Opening <i>Hayward</i> 	N1020
1-1/2" Insider Eyeball Fitting w/ 1" Opening <i>Hayward</i>	N1023
1-1/2" Insider Eyeball Fitting w/ 3/4" Opening <i>American</i> 	N1025
Fits American Products 7" Venturi Jet (N1062)	
1-1/2" Insider Eyeball Fitting w/ 1/2", 3/4", 1" Hole & Test Plug <i>Pentair</i>	N1021
1-1/2" Insider Eyeball Fitting w/ Lock Ridge <i>Aquadapter</i>	N1203

Gray Threaded Eyeball Fitting

Gray Threaded Eyeball Fitting 1-1/2" MPT w/ 3/4" Opening	N1019
Dark Gray Waterway Eyeball 400-1419D-DKG 1-1/2" w/ 3/4" opening	N1072
Dark Gray Waterway Eyeball 400-1419E-DK 1-1/2" w/ 1" opening	N1088
Dark Gray Waterway Eyeball 400-1417EB 1-1/2" w/ 1" opening	N1168
Light Gray Waterway Eyeball 400-1417D 3/4" opening	N1235

Eyeball Removal Tools

Hayward Eyeball Removal Tool <i>SP1419T</i>	N1073
Eyeball Seat Wrench	N1193

Swimquip Eyeball Fittings

White Swimquip Eyeball Ball/Face Plate Kit 	N1048
White Swimquip Eyeball Inlet Fitting	N5147
Gray Swimquip Eyeball Inlet Fitting	N5149



Circulator

Rotating Return, Replaces STD Eyeball	N1030
---------------------------------------	-------

INLET / VACUUM FITTINGS

For Concrete Pools

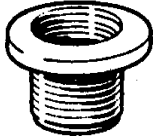
- SP1022 Threaded Inlet 1½" FIP x 2" MIP  ITEM NO. N1000
- SP1022S Slip Inlet 1½"SKT x 2" MIP N1005
- 54-2405 Slip Inlet 1½"SKT x 2" MIP N1024
- SP1022INS Insert Inlet 1½"FIP x 1-1/2" Slip stub end N1007
- SP1023S Slip Fitting 1½" w/ Locknut and Gasket L4078

Gray Vacuum Wall Fitting N1013
1½"SKT x 2" MIP

Dark Gray Wall Fittings N1057
215-9155-DKG 1½"FIPx1½" SLIP

Black Vacuum Wall Fittings
 SP1022BLK 1½"FIPx2" MIP V5028
 SP1022SBLK 1½"SKTx2" MIP N1147
 215-9151B 1½"FIPx2" MIP N1036

Chrome-Brass Vacuum Fitting
 1½" FIP x 2" MIP w/ Plug N1075
 1½" Chrome Vac Plug Only N1077
 Frost Vac Fitting w/ Plugs N1043
 2" Chrome Vac Plug Only N1052

Arneson Vac Lock Safety Wall Fitting E1W400
W400 (White)

Arneson Vac Lock Safety Wall Fitting E1W401
W400 (Black)

INLET / OUTLET FITTINGS

For Vinyl Pools

SP1023 Inlet/Outlet Fitting w/ Locknut & Gasket  L4075

862004 Inlet/Outlet Fitting w/ Locknut & Gasket N1038

SP1025 Inlet/Outlet Fitting w/ Locknut & Gasket (Long)  L4080

SP1408 Inlet/Outlet Fitting w/ Locknut/Spacer  L4070
 Face Plate L4416
 Gasket L4420
 Screw Set (Set of 6) L4422

SP1411 Fitting & Faceplate w/ Gaskets & Screws L4072

FLOOR INLETS

Chrome Floor Inlet Fitting 1½"  N1042
w/Adjustable Top A41014-0

Adjustable Top Plate Kit G7106
for Chrome Floor Inlet Fitting

WALL INLETS

For Concrete Pools

SP1424S Wall Inlet - Adjustable  ITEM NO. N1045
1½"SKT x 2" MIP

SP1424 Wall Inlet - Adjustable N1046
1½"FIP x 2" MIP

Diffuser Plate  N1418
 Face Plate Grate N1414
 Grate Screws (Set/2) N1420
 Spinner Valve Assy. N1416

Swimquip Variable Wall Inlets (White)
 1½" Complete-Slip 08429-0000 N5144
 1¼" Complete-Slip 08428-0000 N1018

 Swimquip Variable Wall Inlet - (Gray)
 1½" Complete 08429-0100 N5148

S.S. Adjustable Return Plates  N1051
1½" Inlet Fitting 41470

SP1026 Safety Grate Insert  N1035

Return Grate Cover - S.S.  N1424
For Hayward Return Fitting (set of 2)

Waterway Return Fitting N1229
1½" FPT x 2" Insider (Black)

Waterway Return Wall Fitting N1230
1½" FPT x 1½" insider (Gray)

Waterway Return Fitting N1231
1½" FPT x 2" Insider (Gray)

Waterway Return Fitting N1233
1½" FPT x 2" Insider (Dark Gray)

EQUALIZER SUCTION FITTING

1½" Equalizer Suction Fitting N1216
White 08011-0000

1½" Equalizer Suction Fitting N1215
Gray 08011-0100

1½" Equalizer Suction Fitting N1220
Black 08011-0200

Cover Plate Kit for Equalizer N1217
White 08010-0000

Cover Plate Kit for Equalizer N1219
Gray 08010-0100

Cover Plate Kit for Equalizer N1221
Black 08010-0200

BULKHEAD FITTINGS (SCH 80)

Special Order

1½" Bulkhead Fitting for Tank N1217
2" Bulkhead Fitting for Tank V1222

FLOOR RETURNS

For Concrete Pools

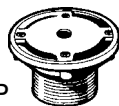

SP-1425S 1-1/2" SKT x 2" MIP N1050
Adjustable Floor Inlet Fitting

SP-1425 1-1/2" FIP x 2" MIP N1049
Adjustable Floor Inlet Fitting

Swimquip Complete Floor Return
08417-0000 N1117
w/Adjustable Top

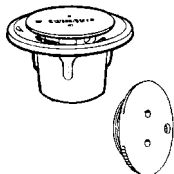

Cover Only N1116
Swimquip Return
08417-0005E

Swimquip Floor Return - Black N1174
08417-0200 w/ Adjustable Top

Cover Only Black 08417-0005CE N1133

Swimquip Floor Return - Gray N1197
08417-0100 w/ Adjustable Top

Cover Only Gray 08417-0005BE N1169

GUTTER DRAINS

Gutter Drain - White N1137
SP1019

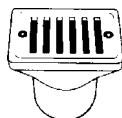

Grate Only - White N1184
Gutter Drain

Gutter Drain - Black N5153
54-2097

SWIM JET FITTINGS

Softer Fitting
Hydro Air Swim Jet Fitting M5063
w/ 1" Nozzle #16-5759

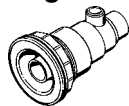

Speck Complete Jet M1450
2303002000

Hayward 1½ Turboboost Spa Jet Fitting N1054
SP1450

SPRAY INLETS



Deck or Wall Spray Inlet - 1" FPT N4742
Sprays Water at 45 Degree Angle

Waterway Air Inject Cap N1039

Aerator Nozzle #86201500 N1040
Used as return spray nozzle

Hayward Nozzle - Large N1451
SPX1430C



Pentair Venture Jet ½" Nozzle M1522
46540100

FILL SPOUTS

3/4" Fill Spout - MPT N1159
1" Fill Spout - MPT N1160
1-1/2" Fill Spout - MPT N1165

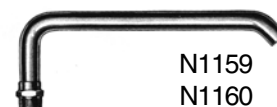

THROTTLING PLUGS

1-1/2" Throttling Plug N1140
w/ Washer
Washer Only for Throttling Plug N1141



AUTOFILLS

Letro Water Leveler L4950
Automatic Control
w/ Fluidmaster Valve

Pool Sentry  L4960
Water Level Control

PoolMiser L4965
Complete Water Leveler

SmartMiser L4966
Wireless Controlled
Water Leveling Device

Levolor II Electronic Water Leveler L4953
110V w/200' wire

Levolor II Electronic Water Leveler L4954
220V w/200' wire

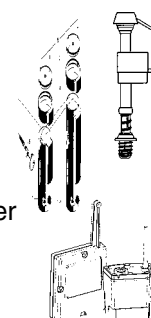

HYDROTHERAPY UNITS

Hydrotherapy Unit PVC with 7" Extension N1062
(Use with 1-1/2" Slip Eyeball)

Replacement Nozzle for Hydrotherapy Jet - 5/16" M1521+

Jet Air Hydrotherapy Unit **1430** 1-1/2" FIP *(For Permanent Installation)* N1055

Jet Air Hydrotherapy Unit **1430S** 1-1/2" Slip *(For Permanent Installation)* N1064

Jet Air Hydrotherapy Unit **1430SSE** Thru Wall *(For Permanent Installation)* N1066

Jet Air Hydrotherapy Unit **1431-11-1/2"** MPT *(For In-Pool Installation)* N1056

Jet Air Hydrotherapy Unit **1433** 1-1/2" FIP *(Package)* N1058

(Includes: SP-1430 Unit, SP-1022 Receptacle & SP-1420 Nozzle)

Removal Tool for Jet Air Nozzle - SP-1430-T N1074

Jacuzzi **C20E** Hydrotherapy Fitting w/Eyeball Assembly N1065
15-20 GPM

Waterway Spa-Rotating Therapy - 212-9170 N1166





Massage Jet 1/2" MPT

+Limited Stock







CUP ANCHORS

Round Cup Anchor 41132 Chrome/Brass w/Cross Bar		ITEM NO. N1185
Cup Anchor 41141 Chrome/Brass w/Adjustable Eyebolt		N1195
Plastic Cup Anchor w/S.S. Bar SP-1040		N1180
Plastic Cup Anchor - Black	w/SS Bar	N1181
Plastic Cup Anchor - Dark Grey	w/SS Bar	K3533
Plastic Cup Anchor - Lite Grey	w/Plastic Bar	N1202
Rope Anchor - Lite Grey	w/SS Bar	N1207
Plastic Cup Anchor - Dark Grey	w/Plastic Bar	N1206

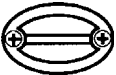
EYEBOLTS

S.S. Eyebolt Only 1/2"		ITEM NO. N1205
Flush Lane Anchor w/ Adjustable Eyebolt		N1200
Rope Eye with Lag		N1210
Arrow Rope Eye Holder		N1190

ROPE ANCHORS FOR LINER POOLS

	Oval Rope Eyes Curved w/Screws	(2/Bag)	L4110
	Oval Rope Eyes Flat w/Backup Plate	(2/Bag)	L4120
	Rope Eye Oval Flat w/Screws	(2/Bag)	L4115
	Eye Bolt w/ Removable Eye for Vinyl	(2/Bag)	L4125
	Eye Bolt Assy - ABS for Vinyl	(2/Box)	L4126
	Eye Bolt Assy - ABS w/Locknut SP0404	(Each)	N1032
	Eye Bolt w/ Washer		N1208

CARETAKER PARTS

Wingmaster Caretaker Wrench	V7236
Replacement Cleaning Heads	
Pop-Up Head - Threaded (Floor)	Z4000
Pop-Up Head - Bayonet (Floor)	Z4040
Retro Cleaning Head & Face Plate	Z4004
Head Removal Tool	Z4020
Clear Bench Nozzle	Z4043

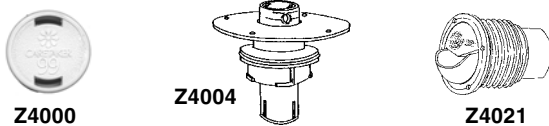

Carousel Rotating Eyeball

Carousel Rotating Eyeball 3-1-1	Z4021
---------------------------------	-------

Thread Care Return Inlet Fittings

1-1/2" Black	3-1-12	Z4016
1-1/2" White		Z4014



Water Valve & Parts

Replacement Valve	Z4006
Complete Water Valve	Z4007
Valve Rebuilding Kit	Z4008
Cup Strainer	Z4010
Valve O-Ring Kit	Z4012
Bottom Plate	Z4022
V-Clamp with Nut	Z4030
2" Union - Complete	Z4032
Union Adapter	Z4034
Union Nut	Z4036
O-Ring for Union	Z4028
Pressure Relief Valve	Z4017
Pressure Gauge 1-3-1	Z4038

SYLVAN POOL ACCESSORIES

Skimmer Basket	K7133	6" Plastic Grate- White	Z5034
Skimmer Lid w/Cap 8-3/4"	Z5020	6" Plastic Grate - AV White	Z5035
Skimmer Lid-Lock Down Type	Z5022	Grate Screw for AV Grate	Z5039
Plastic Ladder Tread 15 Degree	Z5000	Josam Plug 1-1/2"- Plastic	Z5036
Escutcheon Plate-Plastic	Z5001	Josam Plug "T" Wrench- Plastic	Z5037
Plastic Rope Hook Only (Each)	Z5018	Replacement Cartridge 14-3/4"	Z5050
Sylvan Rope Kit 22 Ft w/3 Floats	X1086	Hi Perm Filter Bag 11"	Z5043



N1083

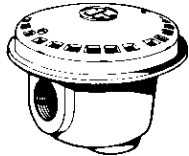

N1085

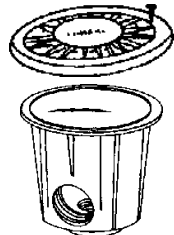

N1146

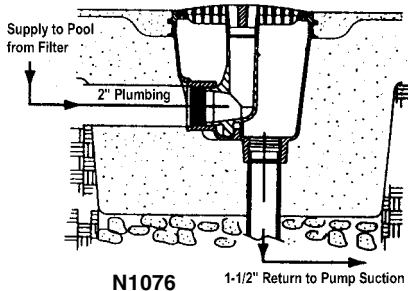

N1076

1-1/2" Return to Pump Suction

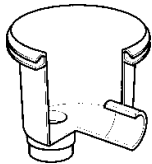

SWIMQUIP

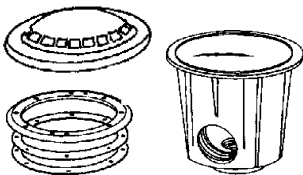

JACUZZI

MAIN DRAINS - Round

		ITEM NO.
1-1/2" Main Drain (7-3/4" Grate)	SP1053AV (2-pak)	N1070
<i>1-1/2" Side x 2" Bottom</i>		
1-1/2" Main Drain (7-3/4" Grate)	SP1153AV (2-pak)	N1083
<i>Anti-Vortex 1-1/2" Side x 2" Bottom</i>		
1-1/2" Main Drain (7-3/4" Grate)	SP1051AV (2-pak)	N1085
<i>Anti-Vortex 1-1/2" Side x 1-1/2" Bottom</i>		
1-1/2" Main Drain (Jacuzzi)	MD-G15-GRT (ea)	N1146
<i>1-1/2" Side x 1-1/2" Bottom</i>		
1-1/2" Main Drain (Jacuzzi)	MD-G15-AV (ea)	N1060
<i>Anti-Vortex 1-1/2" Side x 1-1/2" Bottom</i>		
1-1/2" Main Drain (Pentair)	542031 (ea)	N1209
<i>Anti-Vortex 1-1/2" 2" Ports on the Bottom</i>		
2" Main Drain (7-3/4" Grate)	SP1054AV (2-pak)	N1099
<i>Anti-Vortex 2" Side x 2" Bottom</i>		
2" Main Drain (7-3/4" Grate)	SP1154AV (2-pak)	N1082
<i>A.V. w/Adjustable Collar 2" Side & Bottom</i>		
2" Main Drain (7-7/8" Grate)	SP1052AV (2-pak)	N1078
<i>2" Side x 1-1/2" Bottom</i>		
2" Main Drain (Jacuzzi)	MD-G2-AV (ea)	N1143
<i>2" Side x 1-1/2" Bottom</i>		
2" Swimquip Main Drain Sump	07017-0103 (ea)	N1104
<i>2" Side x 1-1/2" Bottom</i>		
Frame & Grate (8" A.V.)	07017-0741 (ea)	N1086
<i>(8" Anti-Vortex - Swimquip)</i>		

MAIN DRAIN BUMPER

Hayward Main Drain Bumper	N1425
<i>Fits Hayward A.V. Drains to Keep Cleaners off the Main Drain</i>	

MAIN DRAINS - Black

Black Main Drain (7-7/8" Grate)	54-2041	N1084
<i>Anti-Vortex 1-1/2" I.D. x 2" O.D. Slip</i>		

MAIN DRAINS - Gray

Gray Main Drain Sump Only	07017-1103	N1103
<i>No Grate (Swimquip) 2" Side, 1-1/2" Bottom</i>		
Gray Frame & Grate (8" A.V.)	07017-1741	N1114
<i>(8" Anti-Vortex - Swimquip)</i>		

MAIN DRAINS- Liner Pools

White Main Drain 1-1/2" Anti-Vortex	SP1048AV (2-pak)	L4095
White Main Drain 2" Anti-Vortex	SP1049AV(2-pak)	L4092
White Main Drain - 1-1/2" Anti-Vortex Jacuzzi	(ea)	L4097
White Main Drain - 2" Anti-Vortex Jacuzzi	(ea)	L4091



MAIN DRAIN ACCESSORY KIT

Reduces risk of entrapment or evisceration from suction

Hayward Main Drain Accessory Kit SP1048RKIT

*For use w/ most new or existing Hayward round main drains

ITEM NO.
N1095

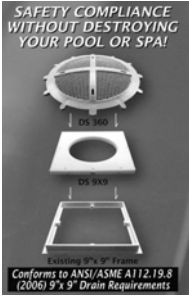

N1211



ANTI-HAIR SNARE PLUS

Anti-Hair Snare Drain Assembly
w/ mud ring/cover/screws

White
Gray
Black



N1162
N1212
N1214
N1201
N1167
N1211

Star 100 Main Drain Cover
Universal Frame/Adapter (for Swimquip)

Drain Safe Frame and Grate, one size fits most main drains up to 9" x 9"

*One size fits all. Helps eliminates hair entanglement & child evisceration. Minimizes entrapment
Screws available on page 169*

COLLECTOR TUBE

Collector Tube for Main Drain - 1-1/2" & 2"

N1120



N1120



N1150

HYDROSTATIC RELIEF VALVES

Hydrostatic Relief Valve, ABS - 1-1/2" & 2"
Astral Hydrostatic Relief Valve, ABS - 1-1/2"
American Hydrostatic Relief Valve, ABS - 1-1/2"
Hydrostatic Relief Valve, Brass - 1-1/2"

N1150
N1150A
N1530
N1155

Tool for ABS Hydrostat Removal SP1056T

N1156

SUMPS FOR MAIN DRAINS

3" Main Drain Sump for 9" x 9" Frame & Grate
4" Main Drain Sump for 12" x 12" Frame & Grate
6" Main Drain Sump for 12" x 12" Frame & Grate
8" Main Drain Sump for 18" x 18" Frame & Grate

N1121
N1091
N1089
N1097

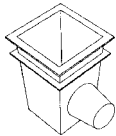

SQUARE FRAMES & GRATES



7-3/4"	Round Frame & Grate	Anti-Vortex	N1111
9" x 9"	Frame & Grate	Plastic (3/4" Thick)	N1170
9" x 9"	Frame & Grate	Plastic Black	N5150
12" x 12"	Frame Only	Plastic (1" Thick)	N1132
12" x 12"	Frame & Grate	Plastic (3/4" Thick)	N1128
12" x 12"	Frame & Grate	Plastic (1" Thick 2-pak)	N1125
12" x 12"	Frame & Grate	Plastic Anti-Vortex	N1124
12" x 12"	Frame & Grate	Plastic Black	N5152
12" x 12"	Frame & Grate	Chrome	N1135
18" x 18"	Frame Only	Plastic Hayward	N1186
18" x 18"	Frame & Grate	Plastic Pentair (3/4" Thick)	N1126
18" x 18"	Frame & Grate	Plastic Hayward	N1123

REPLACEMENT GRATES (Square)

9" x 9"	Grate Only	White (3/4" Thick)	N1177
9" x 9"	Grate Only	White (1" Thick)	N1176
9" x 9"	Grate Only	Black	N1163
12" x 12"	Grate Only	Plastic (3/4" Thick)	N1129
12" x 12"	Grate Only	Plastic (1" Thick)	N1130
12" x 12"	Grate Only	White Anti-Vortex	N1127
12" x 12"	Grate Only	Black	N1164
12" x 12"	Grate Only	Chrome	N1134

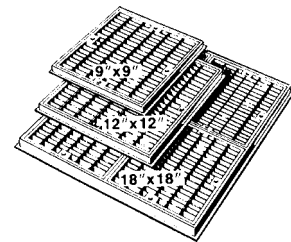

PacFab/Seablue Style
3/4" M.D. Frame & Grates

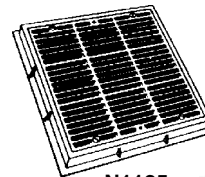

N1125

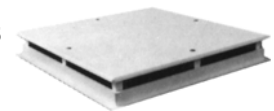

N1124

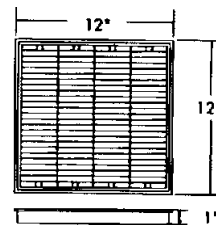

N1130

REPLACEMENT GRATES (Round)

For liability purposes, we strongly recommend conversion of all types of round main drain grates (flat & anti-vortex) to "Anti-Hair Snare Plus" on page 196. One size fits all (adapter needed for (Sta-Rite/Swimquip brand). Screws listed down below.

		ITEM NO.
American A.V. Plate	871024	L2039
Anthony Flat Grate - White	ABF-51-W-CO	N1112
Anthony Anti-Vortex - White	ABF-64-W-CO	N1113
Anthony Frame & Grate A.V.	ABF-64-W	N1111
4-1/8" Flat Grate - Chrome	Sylvan	N1094
5-3/8" Flat Grate - White	Sylvan	Z5034
6" Anti-Vortex Grate - White	Sylvan	Z5035
6-1/2" Jacuzzi A.V. - White	43-1024-09R	N1087
7-3/4" A.V. Grate - White	SP1048E	N1456
7-3/4" A.V. Grate - Black	SP1048EBLK	N1410
7-3/4" A.V. Grate - Black	SP1048E-BLK	N1410
7-3/4" A.V. Frame & Grate	SP1030AV-2 Pak	N1034
7-3/4" A.V. Frame & Grate - Black	- Black	N1101
7-11/16" Sta-Rite Frame & AV plate - Black		N1107+
8" Swimquip A.V. Frame & Grate - White		N1086
8" Swimquip A.V. Frame & Grate - Gray		N1114
8" Pentair A.V. Main Drain & Grate - Black		N1080
Waterway A.V. Frame & Grate - Gray	640-2317	N1223
Waterway A.V. Frame & Grate- D. Gray	640-2319	N1225
Waterway A.V. Frame & Grate- Black	640-2311	N1227

+Limited Stock

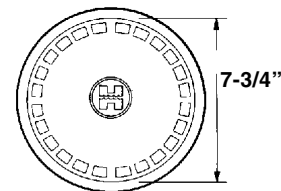

N1456

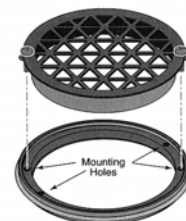

Swimquip
M.D. Grate

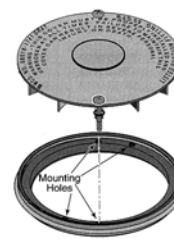

Swimquip
Anti-Vortex Grate



MAIN DRAIN SCREWS

American

		ITEM NO.
Sealing Screw #13-16 x 1-1/4" for Concrete & Liner Anti-Vortex	98207200	L4928
Sealing Screw #13-16 x 1" for Concrete & Liner Regular	98202900	L4929

Anti-Hair Snare

Grate Screw (Set of 6) Fits Sta-Rite/Swimquip Main Drains	SCR-006	N1167S*
Grate Screw (Set of 14) Fits Hayward, Pentair & others	SCR-014	N1162S*

Hayward

		*Non-Stock Item
Grate Screw - Nylon for SP1031 (9x9), 1032 (12x12) & 1033 (18x18)	SPX1031-Z-1	N1188
Grate Screw (Set of 2) for SP1030AV (Medium)	SPX1039-Z-1-D	N1413
Grate Screw (Set of 2) for SP-1048-C (Short)	SPX1425-Z-3-2	N1420
Grate Screw (Set of 2) for SP1051 & SP1154 (Long)	SPX1030-Z-1A	N1459
Grate Screw (Set of 2) for SP1048 & SP1049AV (Liner - Extra Long)	SPX1030-Z-2A	N1460
Frame Screw (Set of 8) for SP1048 & SP1049	SPX1039-Z-1-8	N1454

Pentair (PacFab)

Grate Screw - Flat Phillips #12 x 1" for Gunitite & Vinyl	55-2472	H3253
Grate Screw - Flathead #10 x 3/4" for Regular Cover	55-2473	L4093+

Sylvan

Screw for Anti-Vortex Cover		Z5039
-----------------------------	--	-------

Anthony

Light Face Ring Screw		Z7036
-----------------------	--	-------

+Limited Stock

AMERICAN PRODUCTS S-20

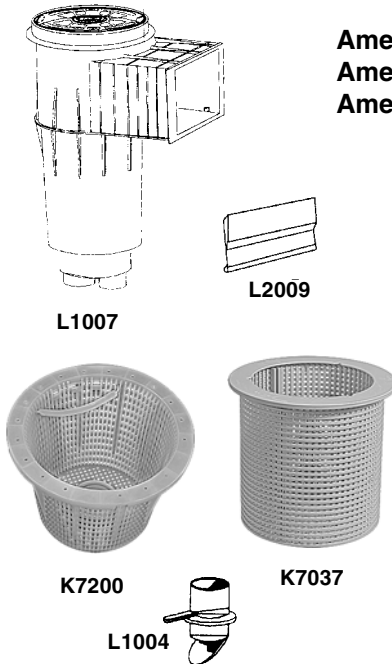

American Products S-15 w/ Circular Weir	1-1/2" FIP	ITEM NO. L1000
American Products S-20 Twin Port Skimmer	1-1/2" FIP	L1007
American Products S-20 Twin Port Skimmer	2" FIP	L1008
Lock Down Skimmer Lid	85007400	L1006
Skimmer Lid (Generic)		L1001
American Vac Plate for Skimmer	850019	L1002
Lid w/Ring Seat 9" - Complete (White)	85000400	L2003
Grout Ring Seat for Lid	85000600	L2004
Extension Collar for Ring Seat	85002300	L1005
American Skimmer Lid w/Grout Ring (Beige)	85018000	L4943
Tapered Basket for S-20 Skimmer	B-200	K7200
Tapered Basket for American V38-125 (Super HD Basket)		K9982
Flap Weir 8" (Straight)	85001500	L2009
Circular Basket for S-15 Skimmer		K7037
Floating Weir for S-15 Skimmer		K7038
Diverter Vari-Flow, Plastic for Skimmer		L1004
Equalizer Spring Valve 2" (for NSF Listing)	87204600	N1530
Float Valve Assembly for S-20	85015200	L2036
Trimmer Valve Plate	85002400	L2015

HAYWARD SP-1082 SERIES

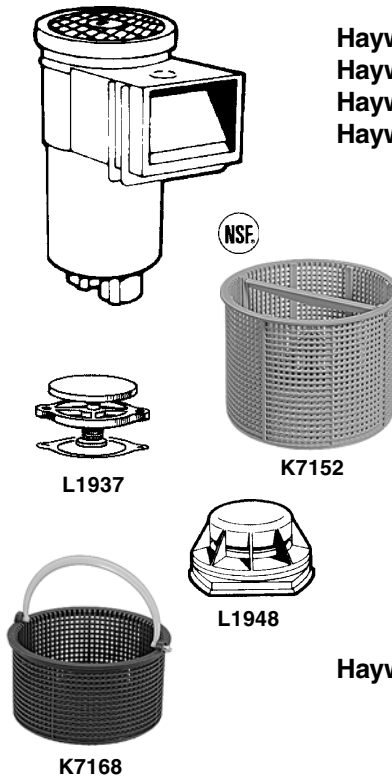

Hayward SP10821 Skimmer with Square Lid	1-1/2" FIP	L1040
Hayward SP1082 Skimmer with Square Lid	2" FIP	L1042
Hayward SP10821R Skimmer with Round Lid	1-1/2" FIP	L1041
Hayward SP1082RC Skimmer with Round Lid	2" FIP	L1928
Square Lid for Hayward Skimmer	SP1082E	L1930
Adjusting Collar for Square Lid	SP1082F	L1404
Hayward New Style Ext. Collar For SP1082	SPX1082F	L1400
Round Lid for Hayward Skimmer	SP1084R	L1934
Adjusting Collar for Round Skimmer Lid	SP1084P	L1410
Extension Collar for Hayward Skimmer	SP1084P1	L1939
Basket for Hayward Skimmer	SP1082CA	L1949
Basket for Hayward Skimmer (Aladdin)	B-152	K7152
Q-Products EZ Out Skimmer Basket		L6000
Weir 7-13/16" for Hayward Skimmer	SP1082K	L1932
Equalizer Valve (for NSF Listing)	SP1078	L1937
Float Valve Assembly (for NSF Listing)	SP1082FV	L1948
Kit w/Float Valve & Equalizer (NSF Listing)	SP108FVEKIT	L1927
Skimpro Tower Vented Basket		L4302
Basket for U-3, Sta-Rite, Hayward (Super HD Basket)		L9984

HAYWARD SP1096 SKIMMER

Hayward SP1096 Small Economy Wall Skimmer	1-1/2"	L1045
Basket Assembly	SPX1096CA	L4924
Basket (Generic)	B-168	K7168

ACCESSORIES FOR HAYWARD SKIMMERS

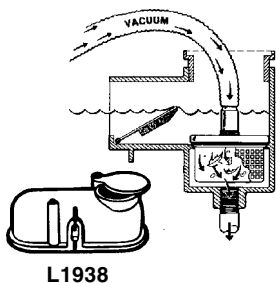

Rainbow Vac Mate	R211100	L1055
Skim-Vac Cartridge System	SP1110	L1022+
Skim-Vac (1-1/4"/1-1/2" Elbow) 1089	SP11071	L1941
Skim-Vac (1-1/2" Straight) 1082, 1075	SP1107	L1935
Skim-Vac (1-1/2" Straight) Deluxe	SP1106	L1936
Skim-Vac (1-1/2" Straight) 1070	SP11063	L1942
Vac Hose Adapter 2" MPT x 1-1/2" Smooth	SP1082Z3	L1933
Skimmer Diverter Valve/Hayward	SP1082GV	L1938
Slide Plate with Screw	SP1082H1A	L1920

HAYWARD SP-1070 SERIES

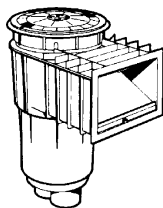

				ITEM NO.	
Hayward SP1070 Wall Skimmer		1-1/2" FIP		L1060	
Hayward SP10712 Skimmer w/Overflow Port		2" FIP		L1023	
Hayward SP10712S Skimmer w/Overflow Port		2" Slip		L1024	
Lid for 1070	SP1070C	L1416	Basket for 1070	SP1070E	L1418
Grout Ring	SP1070B	L1415	Weir	SP1070K	L1421
Extension Collar	SP1070P	L1049	Float Valve Assy	SP1070FV	L1426
			Slide Plate w/Screw	SP1082H1A	L1920

JACUZZI DECKMATE SKIMMER

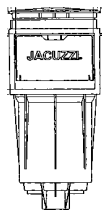

Jacuzzi Deckmate Skimmer 2" Slip	DMG-2S	L1096
Jacuzzi Deckmate Skimmer 2" FIP	DMG-2T	L1098
Lid for Skimmer	43-3051-01-R	L1097
Basket Only	16-1099-02-R	L1099
Vac Adapter Plate	9411-0020	L1478
Float Valve Assembly	9411-0038	L9025

PENTAIR FIBERGLASS SKIMMER

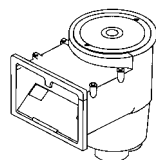

Pentair Fiberglass 1021 Wall Skimmer		L1050
Lid for 1021 Wall Skimmer		L1051
Basket for 1021 Skimmer	Generic	K7043
Basket for 1021 Skimmer	51-3036	L1535
Basket (Commercial)		K743C
Weir for 1021		L1523

PENTAIR BERMUDA SKIMMERS



K7043

Pentair Bermuda Skimmer	2" Slip	L1052
Pentair Bermuda Skimmer	2" FIP	L1545
Pentair Bermuda Skimmer (White)	2" Slip	L1546
Pentair Bermuda Skimmer (Black)	2" Slip	L1536

Lid for Bermuda	(White)	L1519
Lid for Bermuda	(Black)	L1502
Lid for Bermuda	(Tan)	L1501
Grout Ring	(White)	L1517
Grout Ring	(Black)	L1504
Grout Ring	(Tan)	L1503

Basket for Bermuda Skimmer		L1518
Weir for Bermuda	(White)	L1053
Weir for Bermuda	(Black)	L1508
Vac-Plate for Bermuda Skimmer		L1509
Float Valve Assy		L1530
Equalizer Valve Assy		L1510

STA-RITE U-3 SWIMQUIP SKIMMERS

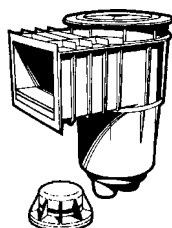

Sta-Rite U-3 Skimmer	2" Slip	NSF	08650-1404	L1054
Sta-Rite U-3 Skimmer	2" Threaded	NSF	08650-1403	L1057
Sta-Rite U-3 Skimmer	2" Slip		08650-4404	L1067
Sta-Rite U-3 Skimmer	2" Threaded		08650-4403	L1065
Sta-Rite U-3 Skimmer	2" Threaded (Tan)		08650-5403	L1076
Sta-Rite U-3 Skimmer	2" Threaded (Gray)		08650-6403	L1058

Skimmer Lid	(White)	L1061
Grout Ring	(White)	L1082
Extension Collar	(White)	L1080
Skimmer Lid	(Gray)	L1078
Skimmer Lid	(Tan)	L1083
Lid & Grout Ring	(Tan)	L1077

Basket for U-3 (Generic)		K7009
Basket for U-3 (Sta-Rite)		L1081
Weir for U-3 Skimmer w/ Hinge		L1062
Float Valve Assembly		L1063
Vac Plate for U-3 Skimmer		L1064
Spring Valve 2"		L1086

WATERWAY

Ultimate In-Ground Skimmer	2" Socket (White)	L1026
----------------------------	-------------------	-------

**HAYWARD WALL SKIMMERS
FOR LINER POOLS**

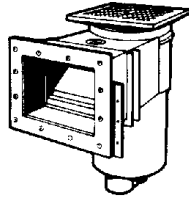

SP-1084-1

	ITEM NO.
Hayward 10841 Liner Skimmer w/Square Lid 1-1/2" Threaded	L4000
Hayward 10841OM Liner Skimmer w/Square Lid 1-1/2" Threaded	L4001

12-Hole Face Plate for Hayward Skimmer	SP1084L	L4910
12-Hole Gasket for Face Plate	SP1084B	L4911
Snap-On Face Plate Cover - White	SP1084F	L1954
Face Plate Screw Set	SP1084Z1A	L4940
Face Plate Screw Set - Self Tapping	SP1084Z4A	L4264
Face Plate Screw Set - Self Tapping - 1-1/4"	SP1084Z4AM	L1346

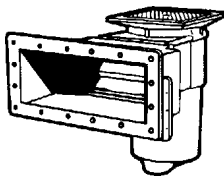

SP-1085-1-OM

Hayward 10852 Wide Mouth Skimmer 9-1/4" Throat (1-1/4" Long Screws)	L4010
Hayward 10852OM Wide Mouth Skimmer 9-1/4" Throat	L4012
Hayward 10851OM Wide Mouth Skimmer 12-1/4" Throat	L4009

16-Hole Face Plate for Hayward Skimmer	SP1085B	L4912
16-Hole Gasket for Face Plate	SP1085D	L4913
Snap-On Face Plate Cover - White	SP1085F	L1955
Face Plate Screw Set - Self Tapping	SP1085Z1A	L1448
Face Plate Screw Set - Self Tapping - 1-1/4"	SP1085Z1AM	L1450



HAYWARD ABOVE GROUND SKIMMERS

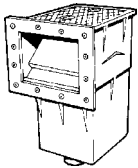

SP-1089

Hayward 1089 Liner Pool Skimmer- 1-1/2" Threaded	L4020
Hayward 1097 Liner Pool Skimmer w/ 12-1/2" Throat	L4050
Hayward 1091LX	L4042
Hayward SP1090WM Wide Mouth Skimmer	L4043
Hayward SPX1091C Skimmer Basket For SP1091LX	L4802

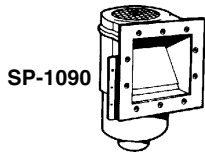

SP-1090

10-Hole Face Plate for Hayward 1090 Skimmer	SP1090D	L4914
10-Hole Gasket for Face Plate for 1090 Skimmer	SP1090E	L4915
Face Plate Screw Set - 1-1/4" Long	SP1030Z1C	N1461
Weir for Hayward Skimmer	SP1096K	L4916
Weir for Hayward Skimmer	SPX1090WMW	L4904
Basket for Hayward: 1090, 1096, 1097, 1098	B-168	K7168
Lid for Hayward Skimmer	SP1096B	L4917

SKIM VACS & ACCESSORIES

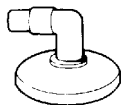

SP-11041

Skim Vac w/ 1-1/4" / 1-1/2" Elbow (1090, 1091, 1092)	SP11041	L4918
Skim Vac w/ 1-1/4" / 1-1/2" Combo Adapter	SP11054	L4919
Skim Vac w/ 1-1/4" Elbow (1090,1091,1092)	SP11052	L4920
Skim Vac w/ 1-1/2" Straight Barb (1090,1096,1098)	SP11051	L4923
Skim Vac w/ 1-1/4" / 1-1/2" Elbow (1094)	SP1094D	L4226
Skim Vac Delux	SP1106	L1936
Hayward Multi Flo Valve Kit	1075-LWS	L1953
Basket Buddies (5 pack)		L1956
Basket Buddies (3 pack)		L1957
Rainbow (Pentair) Vac Mate	R211100	L1055

JACUZZI SKIMMERS - LINER POOLS AND SPAS

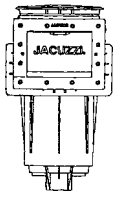

Jacuzzi Deckmate Skimmer - 1-1/2" Slip for DMV-15S ITEM NO.
L1094
 Jacuzzi Deckmate Skimmer - 1-1/2" Wide Mouth L1104

Lid for Skimmer #43-3051-01-RWHT L1097
 Basket for Skimmer #16-1099-02-R000 L1099
 Vac Adapter Plate #9411-0020 L1478



L4061

SPA SKIMMERS

SV Jacuzzi Spa Skimmer - Front Access M1069
 SV Jacuzzi Skimmer Basket - #B-202 43-0676-02 K7202
 Dress Up Front Plate - White For SV Skimmer M1056
 Hayward Spa Skimmer- Front Access SP1099S L4052
 Basket for SP1099S L4051
 Waterway Front Access Skimmer w/Trim Plate L4061



PENTAIR SKIMMER - LINER POOLS

Bermuda Widemouth Skimmer for Liner Pools - 1-1/2" Slip L1924*

**Non Stock Item*

ABOVE GROUND WALL SKIMMERS

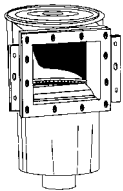

Olympic Skimmer w/Return Ftg. & Vac Plate - Above Ground Pools L4170

Olympic Skimmer w/Return Ftg. & Vac Plate - Wide Mouth L1600

Waterpik Wide Mouth Skimmer - Gray L1602



L4171

Weir for Skimmer	L4173	10-Hole Face Plate	L1025
Return Fitting	L4176	Lid for Skimmer	L4179
Gasket Kit for Return	L4178	Basket for Skimmer	L4171
Eyeball & Face Ring	L4174	Skim Vac	L4172
Face Ring Only	L4175		

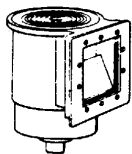

American FAS-100 Skimmer for Above Ground Pools L4030*

Pentair FAS-100 Skimmer for Above Ground Pools w/ Accessory Kit L4035*

Pentair Wide Mouth Skimmer for Above Ground Pools - Grey L4034*

Pentair Wide Mouth Skimmer for Above Ground Pools - White L4033*

Pentair Wide Mouth Skimmer for Above Ground Pools - Black L4036*

Lid for Skimmer	L4933	10-Hole Face Plate	L4930
Weir for FAS-100	L4932	10-Hole Gasket	L4931
Basket for FAS-100	K7172	Screw - Face Plate 1-1/4"	L4928
Vacuum Plate	L4934	Screw - Face Plate - 1"	L4929

**Non Stock Item*

L4060

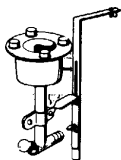

Season Master SM-101RRL Wall Skimmer L1132

Includes return fittings, clamps & elbow

Over the Wall #750-HL Skimmer L4060

NO-NICHE SKIMMERS

Lily Pad Float 8" Complete with Disc L1070
 8" Disc Only for Lily Pad L1071

No Niche #750 Skimmer - 1" FPT L1075
 No Niche #750B Skimmer - 1" FPT (Black) L1075B

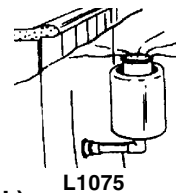

L1075

SKIMMER BASKETS - Replacement



B-9



B-43



B-37



B-38

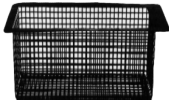

B-72



B-152



B-168



B-200

SKIMMER DESCRIPTION	BASKET NO.	ITEM NO.	HD. ITEM NO.	OEM ITEM NO.
American S-15 Skimmer	B-37	K7037		L4942
American S-15 Circular Weir	B-38	K7038		K8038
American S-20 Skimmer	B-200	K7200	K9982	L4945
American FAS100	B-172	K7172		L4941
Baker Hydro Skimmer	B-136	K7136		L1212
Clayton-Lambert	B-189	K7189		
Hayward 1090 Series Skimmers	B-168	K7168		L4924
Hayward 1082,1084 & 1085 Series	B-152	K7152	K9984	L1949
Hayward 1075 Skimmer	B-152	K7152	K9984	
Hayward 1070 Skimmer	B-9	K7009	K9984	L1418
Jacuzzi - PMT	B-183	K7183		
Jacuzzi Deckmate				L1099
Pentair Bermuda Skimmer	B-9	K7009	K9984	L1518
Pentair 1021 Skimmer	B-43	K7043		L1535
Pentair Commercial	B-43C	K743C		
Paddock	B-72	K7072		
Swimquip U-3	B-9	K7009	K9984	L1081
Sylvan	B-133	K7133		
Olympic				L4171

BASKET BUDDIES



Regular - Fits Most Baskets	(5 Pack)	L1956
Jumbo - Fits Most Baskets	(3 Pack)	L1957
Skimpro Tower Vented Basket for Hayward 1080		L4302
Q-Products EZ-1 EZ Out Skimmer Basket - Hayward		L6000
Q-Products EZ-1 EZ Out Skimmer Basket - Pac-Fab & Sta-Rite		L6002

SKIMMER LIDS - Replacement

SKIMMER DESCRIPTION	ITEM NO.
American Products S-15 / S-20	L1001
American Products FAS100	L4933
Baker Hydro Skimmer 9-7/8"	L1011
Hayward 1084 Round Lid	L1934
Hayward 1082 Square Lid	L1930
Hayward 1070 Skimmer	L1416
Hayward 1075 Skimmer	L1951
Hayward 1096 Skimmer	L4917

SKIMMER DESCRIPTION	ITEM NO.
Jacuzzi PMT	L1068
Jacuzzi Deckmate	L1097
Pac-Fab/Pentair 1021 Series	L1051
Pac-Fab/Pentair Bermuda	L1519
Swimquip/Sta-Rite U-3	L1061
Swimquip/Sta-Rite U-3 Grey	L1078
Sylvan w/Threaded Cap	Z5020
Sylvan Lock-down type	Z5022

REPLACEMENT WEIRS

Lots of 6 Weirs (One Size) 10% Discount

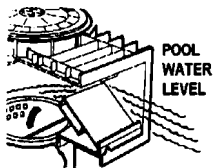

6" Weir	L1100	
7" Weir	L1105	
8" Weir	L1110	
9" Weir	L1115	
10" Weir	L1120	
12" Weir	L1125+	
7-1/4" Weir (Anthony/Pac-Fab)	L1135	
7-5/8" Weir (Hayward/Sylvan)	L1140	
8-1/8" Weir (Jacuzzi)	L1145	
8-3/8" Weir (Swimquip/Hayward)	L1150	
9-3/8" Weir (Baker Hydro)	L1155	

MISC. SKIMMER PARTS

Am Prod 12-Hole Face Plate	L2024
Am Prod 12-Hole Gasket Set	L4935
Am Prod 12-Hole Screw Set	L2026
Baker Hydro Control Plate	L1012
Baker Hydro Skimmer Weir	L1013

Hayward 1075 Grout Collar	L1952
Pentair Widemouth Face Plate	L1516*
Pentair Widemouth Gasket	L1521*
Pentair Widemouth Screw 1"	L1522*

+Limited Stock
*Non-Stock Item

All PVC prices are subject to fluctuations in the petroleum market which could result in constant price changing

SCHEDULE 40 PVC PIPE

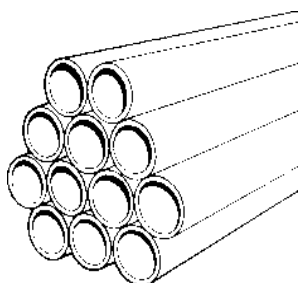

10 Ft. lengths
of PVC pipe
not available
in Springfield, Va.
or Forestville, Md.

		ITEM NO.	
SCHEDULE 40 PVC PIPE	1/2" x 20'	PVC Pipe Cut Per Ft	U8005 U8003
	3/4" x 20'	PVC Pipe Cut Per Ft	U8007 U8006
	1" x 20'	PVC Pipe Cut Per Ft	U8010 U8009
	1-1/4" x 20'	PVC Pipe Cut Per Ft	U8012 U8014
	1-1/2" x 20'	PVC Pipe Cut Per Ft	U8015 U8017
	2" x 20'	PVC Pipe Cut Per Ft	U8020 U8022
	2-1/2" x 20'	PVC Pipe Cut Per Ft	U8025 U8027
	3" x 20'	PVC Pipe Cut Per Ft	U8030 U8032
	4" x 20'	PVC Pipe Cut Per Ft	U8040 U8042
	5" x 20'	PVC Pipe Cut Per Ft	U8050 U8052
	6" x 20'	PVC Pipe Cut Per Ft	U8060 U8062
	8" x 20'	PVC Pipe Cut Per Ft	U8080 U8082

CPVC PIPE

		ITEM NO.
1-1/2" x 20'	CPVC Pipe Cut Per Ft	U7515 U7516
2" x 20'	CPVC Pipe Cut Per Ft	U7520 U7522

SCHEDULE 80 PVC PIPE

1/2" x 20'	Schedule 80 PVC Pipe	U7605
3/4" x 20'	Schedule 80 PVC Pipe	U7607
1" x 20'	Schedule 80 PVC Pipe	U7610
1-1/2" x 20'	Schedule 80 PVC Pipe	U7615
2" x 20'	Schedule 80 PVC Pipe	U7620
2 1/2" x 20'	Schedule 80 PVC Pipe	U7625
3" x 20'	Schedule 80 PVC Pipe	U7630*
4" x 20'	Schedule 80 PVC Pipe	U7640*
6" x 20'	Schedule 80 PVC Pipe	U7660*

*Non-Stock Item

BLACK POLY PIPE 100 Lb. Test

1-1/2" x 100'	Polyethylene Pipe	U8510
---------------	-------------------	-------

BROWN SPA FLEX PIPE

1" x 100'	Roll Spa Flex Pipe	U8611
1-1/2" x 50'	Roll Spa Flex Pipe	U8616







FLEXIBLE PVC PIPE

	ITEM NO.
1/2" x 100' Roll	U8605
3/4" x 100' Roll	U8607
1" x 50' Roll	U8609
1-1/4" x 50' Roll	U8619
1-1/2" x 50' Roll	U8615
2" x 50' Roll	U8620

BLACK FLEX PIPE

1-1/2" x 50' Roll	U8638
2" x 50' Roll	U8640

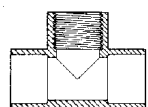
All PVC prices are subject to fluctuations in the petroleum market which could result in constant price changing

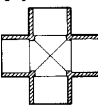
Schedule 40				Schedule 80					Qty/Case	Size	Sched. 40 Item No.	Sched. 80 Item No.	
45° ELBOW (Slip) 	Size	Qty/Case	Item No.	Qty/Case	Item No.								
	1/2"	50	U1305								U2753		
	3/4"	50	U1307	25	U6907	PVC SADDLE					U2754	Numbers in parenthesis are case qty's	
	1"	50	U1310	25	U6910	TEE CLAMP					U2758		
	1-1/4"	25	U1312								U2760		
	1-1/2"	25	U1315	10	U6915	TEE (Slip)					U2780		
	2"	25	U1320	10	U6920						U2505		U7105(25)
	2-1/2"	10	U1325	5	U6925						U2507		
	3"	10	U1330	5	U6930						U2510	U7110(25)	
	4"	5	U1340	5	U6940						U2512		
	5"	5	U1350								U2515	U7115(10)	
	6"	4	U1360	4	U6960						U2520	U7120	
	8"	4	U1380	2	U6980						U2525		
	10"		U13100*								U2530	U7130(5)	
	12"		U13120*								U2540	U7140(5)	
			*Not Stocked								U2550		
		1-1/2"(S x MS)		U1317							U2560	U7160(4)	
	2"(S x MS)		U1322							U2580	U7180(3)		
FEMALE ADAPTER (FPT x Slip) 	1/2"	100	U1205	25	U7305	TEE					U2705		
	3/4"	50	U1207	25	U7307	(S x S x FPT)					U2707		
	1"	50	U1210	25	U7310						U2710		
	1-1/4"	25	U1212	10	U7312						U2712		
	1-1/2"	25	U1215	10	U7315						U2715		
	2"	25	U1220	10	U7320	TEE					U2720		
	2-1/2"	10	U1225	5	U7325	(FPT x FPT x FPT)					U2815	U8418(10)	
	3"	10	U1230	5	U7330						U2820	U8430(5)	
	4"	5	U1240	5	U7340								
	5"	5	U1250										
	6"	4	U1260	4	U7360	REDUCING TEE (Slip x Slip x Slip)							
	8"	4	U1280			25	1-1/2" x 1-1/2" x 1/2"	U2615					
FEMALE REDUCING ADAPTER (Slip x FPT) 	1" x 3/4"		U2907	4	U7111								
	SOCKET ADAPTER (Socket x FPT)	1-1/4"	25	U1412									
		1-1/2"	50	U1415									
		2"	20	U1420									
3"		20	U1430										
4"		20	U1440										
6"			U1460										
22-1/2° ELBOW (Slip)	1-1/2"	20	U1616										
	2"	25	U1622										
	2-1/2"	10	U1626										
	3"	5	U1631										
	4"	4	U1641										
6"	3	U1661											
CROSS (Slip) 	1/2"	50	U3905										
	3/4"	50	U3907										
	1"	50	U3910										
	1-1/4"	25	U3912										
	1-1/2"	25	U3915										
	2"	10	U3920										
2-1/2"	10	U3925											
3"	5	U3930											
4"	4	U3940											
REDUCING TEE (Slip x Slip x FPT)	25	1-1/2" x 1-1/2" x 1/2"	U2733										
	25	1-1/2" x 1-1/2" x 3/4"	U2734										
	10	2" x 2" x 1/2"	U2735										
	10	2" x 2" x 3/4"	U2736										
	10	4" x 4" x 1-1/2"	U2740										
	5	4" x 4" x 2"	U2642										
	5	4" x 4" x 3"	U2643										
	5	5" x 5" x 2"	U2650										
	5	6" x 6" x 2"	U2662										
	5	6" x 6" x 3"	U2663										
5	6" x 6" x 4"	U2664											
2	8" x 8" x 4"	U2684											
2	8" x 8" x 6"	U2686											
2	8" x 8" x 6"	U2686									U7186(2)		

All PVC prices are subject to fluctuations in the petroleum market which could result in constant price changing

Sched. 40			Sched. 80	Sched. 40			Sched. 80
ITEM NO.			ITEM NO.	ITEM NO.			ITEM NO.
QTY/CASE				QTY/CASE			
50	1/2" x 1/4"	U3401		100	1/2" x 1/8"	U4003	Numbers in parenthesis are case qty's U7407(50)
100	1/2" x 3/8"	U3402		100	1/2" x 1/4"	U4005	
100	3/4" x 1/2"	U3405		100	1/2" x 3/8"	U4008	
100	1" x 1/2"	U3407		100	3/4" x 3/8"	U4006	
100	1" x 3/4"	U3410		50	3/4" x 1/4"	U4007	
25	1-1/4" x 1/2"	U3412		100	3/4" x 1/2"	U4009	
25	1-1/4" x 3/4"	U3413		100	1" x 1/2"	U4010	
25	1-1/4" x 1"	U3414		100	1" x 3/4"	U4011	
25	1-1/2" x 1/2"	U3415		25	1-1/4" x 3/4"	U4012	
25	1-1/2" x 3/4"	U3417		25	1-1/4" x 1"	U4013	
25	1-1/2" x 1"	U3418		25	1-1/2" x 1/2"	U4014	
25	1-1/2" x 1-1/4"	U3419		25	1-1/2" x 3/4"	U4015	
10	2" x 1/2"	U3421	Numbers in parenthesis are case qty's U7425(10)	25	1-1/2" x 1"	U4017	
10	2" x 3/4"	U3423		25	1-1/2" x 1"	U4019	
10	2" x 1"	U3420		10	2" x 1-1/4"	U4018	
10	2" x 1-1/4"	U3422		10	2" x 1/2"	U4018	
25	2" x 1-1/2"	U3425		10	2" x 3/4"	U4021	
10	2-1/2" x 1"	U3426		10	2" x 1"	U4022	
10	2-1/2" x 1-1/2"	U3427		10	2" x 1-1/4"	U4023	
10	2-1/2" x 2"	U3429	U7428(10)	10	2" x 1-1/2"	U4020	
10	3" x 1"	U3431	U7431(10)	10	2" x 1-1/2"	U4024	
10	3" x 1-1/2"	U3430		10	2-1/2" x 1-1/2"	U4024	
10	3" x 2"	U3432	U7432 (5)	10	2-1/2" x 2"	U4025	
10	3" x 2-1/2"	U3435	U7435 (5)	10	3" x 2"	U4029	
5	4" x 2"	U3442	U7442 (5)	10	3" x 2-1/2"	U4030	
5	4" x 2-1/2"	U3445		5	4" x 3"	U4042	
5	4" x 3"	U3443	U7443 (5)	5	4" x 1-1/2"	U4039	
5	5" x 2"	U3452		5	5" x 4"	U4050	
5	5" x 3"	U3453		5	6" x 4"	U4060	
5	5" x 4"	U3454	U7454 (5)				
5	6" x 2"	U3462	U7462 (5)	THREADED REDUCER BUSHING (MPT x FPT)	1/4" x 1/8"	U4101	
5	6" x 3"	U3463	U7463 (5)	50	3/8" x 1/4"	U4103	
5	6" x 4"	U3464	U7464 (5)		1/2" x 1/2"	U4104	
5	6" x 5"	U3465		50	1/2" x 1/4"	U4105	
5	8" x 4"	U3484		50	1/2" x 3/8"	U4108	
5	8" x 6"	U3486	U7486 (5)	50	3/4" x 1/4"	U4109	
1	10" x 6"	U3490*		50	3/4" x 3/8"	U4107	
1	10" x 8"	U3492*		50	3/4" x 1/2"	U4110	
1	12" x 8"	U3494*	U7490 (2)	50	1" x 1/2"	U4106	
1	12" x 10"	U3496*		50	1" x 3/4"	U4111	
				25	1-1/4" x 3/4"	U4112	
				25	1-1/4" x 1"	U4113	
				25	1-1/2" x 1/2"	U4114	
				25	1-1/2" x 3/4"	U4115	
				25	1-1/2" x 1"	U4117	
				25	1-1/2" x 1-1/4"	U4119	
				10	2" x 1"	U4121	
				10	2" x 1-1/4"	U4122	
				10	2" x 1-1/2"	U4120	
				10	2-1/2" x 2"	U4125	
					3" x 2"	U4130	
					3" x 2-1/2"	U4131	
				CAP (FPT)	1/2"	U3305	
					3/4"	U3307	
					1"	U3310	
					1-1/4"	U3312	
					1-1/2"	U3315	
					2"	U3320	
					2-1/2"	U3325	
					3"	U3330	
					4"	U3340	
					6"	U3360	

REDUCER BUSHING (SP x Slip)



REDUCER BUSHING (SP x FPT)



THREADED REDUCER BUSHING (MPT x FPT)



CAP (Slip)



CAP (FPT)



*Non-Stock Item

U8340 (5)

U8320(10)

All PVC prices are subject to fluctuations in the petroleum market which could result in constant price changing

**NIPPLES
(MPT X MPT)**

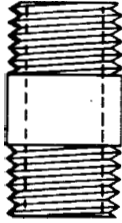

QTY/CASE		ITEM NO.
25	1/8" x 3"	U3102
25	1/4" x Close	U3110
25	1/4" x 3"	U3111
25	1/4" x 6"	U3112
25	3/8" x Close	U3113
25	3/8" x 3"	U3107
50	1/2" x Close	U3114
50	1/2" x 3"	U3115
50	1/2" x 6"	U3116
50	3/4" x Close	U3118
50	3/4" x 3"	U3117
50	3/4" x 6"	U3119
50	1" x Close	U3120
50	1" x 3"	U3121
50	1" x 6"	U3123
25	1-1/4" x 3"	U3125
25	1-1/4" x 6"	U3127
25	1-1/2" x Close	U3129
25	1-1/2" x 3"	U3131
25	1-1/2" x 6"	U3133
25	1-1/2" x 12"	U3135
10	2" x Close	U3136
10	2" x 3"	U3137
10	2" x 6"	U3139
10	2" x 12"	U3141
5	2-1/2" x 6"	U3143
5	2-1/2" x 12"	U3145
5	3" x 3"	U3146
5	3" x 6"	U3147
5	3" x 12"	U3149
5	4" x Close	U3150
5	4" x 6"	U3151
5	4" x 12"	U3153

**PLUG
(Slip)**



**PLUG
(MPT)**



50	1/2"	U3605
50	3/4"	U3607
50	1"	U3610
25	1-1/4"	U3612
25	1-1/2"	U3615
10	2"	U3620
10	2-1/2"	U3625
10	3"	U3630
5	4"	U3640
50	1/2"	U3705
50	3/4"	U3707
50	1"	U3710
25	1-1/4"	U3712
25	1-1/2"	U3715
10	2"	U3720
10	2-1/2"	U3725
10	3"	U3730
5	4"	U3740

SCHEDULE 80 PVC FITTINGS

These fittings are now placed on the previous three pages next to their schedule 40 counterparts. Look for the type and size on pages 204, 205, and 206.

CPVC HI TEMPERATURE FITTINGS

	QTY/CASE	ITEM NO.
1-1/2" 90 Degree Elbow S x S	10	U7535
2" 90 Degree Elbow S x S	10	U7530
1-1/2" 45 Degree Elbow S x S	10	U1316
2" 45 Degree Elbow S x S	10	U1321
1-1/2" Coupling S x S	10	U7525
2" Coupling S x S	10	U7529
1-1/2" Male Adapter S x MPT	10	U7526
2" Male Adapter S x MPT	10	U7532
1-1/2" Female Adapter S x FPT	10	U7527
2" Female Adapter S x FPT	10	U7531
1-1/2" Tee S x S x S	10	U7528
2" Tee S x S x S	10	U7533
1-1/2" x 6" Nipple	25	U7565
1-1/2" x 12" Nipple	25	U7566
2" x 3" Nipple	10	U7541
2" x 6" Nipple	10	U7538
2" x 12" Nipple	15	U7539
1-1/4" x 1-1/2" Red Bush S x T	10	U7536
1-1/2" x 3/4" Red Bush S x T	10	U7540
1-1/2" x 2" Red Bush S x S	10	U7534

All PVC prices are subject to fluctuations in the petroleum market which could result in constant price changing

INSERT POLY FITTINGS

QTY/CASE ITEM NO.

COUPLING (Insert x Insert)

	50	1/2"	U5005
	50	3/4"	U5007
	40	1"	U5010
	20	1-1/4"	U5012
	20	1-1/2"	U5015
	10	2"	U5020
	10	3"	U5025

REDUCING COUPLING (Insert x Reducing Insert)

10	1-1/2" x 1-1/4"	U5115
10	2" x 1-1/2"	U5120

90 ELBOW (Insert x Insert)

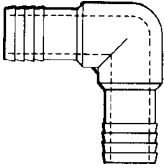
	50	1/2"	U5206
	50	3/4"	U5207
	25	1"	U5210
	10	1-1/4"	U5212
	10	1-1/2"	U5215
	10	2"	U5220

COMBINATION 90 ELBOW (Insert x MPT)

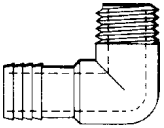
	25	1/2"	U5306
	25	3/4"	U5307
	10	1"	U5310
	10	1-1/4"	U5312
	10	1-1/2"	U5315
	10	2"	U5320

COMBINATION 90 ELBOW (Insert x FPT)

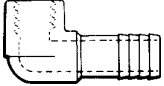
	40	1/2"	U5405
	25	3/4"	U5407
	25	1"	U5410
	10	1-1/2"	U5415
	5	2"	U5420

FEMALE ADAPTER (Insert x Red Insert)

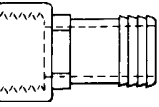
	30	1/2"	U5708
	30	3/4"	U5709
	30	1"	U5710
	25	1-1/4"	U5712
	15	1-1/2"	U5715
	10	2"	U5720

QTY/CASE ITEM NO.

MALE ADAPTER (Insert x MTA)

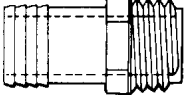
	50	1/2"	U5505
	50	3/4"	U5507
	40	1"	U5510
	20	1-1/4"	U5512
	20	1-1/2"	U5515
	10	2"	U5520
	10	3"	U5530

REDUCING MALE ADAPTER (MPT X Reducing Insert)

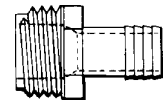

10	1-1/4" MPT x 1-1/2" Insert	U5610
20	1-1/2" MPT x 1-1/4" Insert	U5615
10	2" MPT x 1-1/2" Insert	U5620
10	1-1/2" MPT x 2" Insert	U5622

ADAPTER (Slip to Insert)

24	1-1/2" Insert x 1-1/2" MS	U7913
25	1-1/2" Insert x 1-1/2" FS	U7915

TEE (Insert)

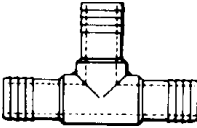
	40	1/2"	U6008
	25	3/4"	U6009
	20	1"	U6010
	10	1-1/4"	U6012
	10	1-1/2"	U6015
	10	2"	U6020

REDUCING TEE (Insert x Insert x Reducing FPT)

10	1-1/4" x 1-1/4" x 1/2" MPT	U6204
10	1-1/2" x 1-1/2" x 3/4" FPT	U6207
10	1-1/2" x 1-1/2" x 1" FPT	U6210

COMBINATION TEE (Insert x Insert x MPT)

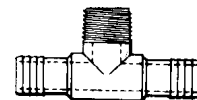

5	1-1/2" x 1-1/2" x 1-1/2" MPT	U6310
---	------------------------------	-------

(Insert x Insert x FPT)

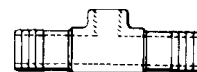

5	1-1/2" x 1-1/2" x 1-1/2" FPT	U6311
---	------------------------------	-------

All PVC prices are subject to fluctuations in the petroleum market which could result in constant price changing

SEALANTS

Teflon Tape - Large Roll
1/2" x 520"

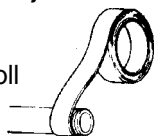

ITEM NO.
V1205

Hercules "Grrrip" 1/2 Pint
All Purpose Threaded/Gasket Sealant

S4087

Permatex Teflon 4 oz. Can
Threaded Sealant

S4109

THREADED PLUGS



1/4"	PVC Threaded Plug	V5002
3/8"	Plastic Threaded Plug	V5004
1/2"	Plastic Threaded Plug	V5005
3/4"	Plastic Threaded Plug	V5007
1"	Plastic Threaded Plug	V5010



1-1/4"	Clean Out Plug	V5012
1-1/2"	Clean Out Plug	V5015
2"	Clean Out Plug	V5020
3"	Clean Out Plug	V5030
4"	Clean Out Plug	V5040
6"	Clean Out Plug	V5060



FLUSH PLUGS w/GASKETS

V5027

1-1/2"	1022-B Plug w/Gasket	V5027
1-1/2"	Plug w/Gasket	V5017

FLUSH PLUGS w/GASKETS

SP1022-Black CYC Vac Receptacle	V5028	
1-1/2"	1022-C Plug w/O-Ring	V5029
1-1/2"	Plug w/O-Ring	V5018



V5016



V5029

1-1/2"	White Flat Plastic Plug	V5016
1-1/2"	Black Flat Plastic Plug	V5019
2"	White Flat Plastic Plug	V5021
1-1/2"	Gray Flush MPT Plug	V5026

BRASS PLUGS



1/8"	Brass Plug	V5101
1/4"	Brass Plug	V5102
3/8"	Brass Plug	V5104
1/2"	Brass Plug	V5105
3/4"	Brass Plug	V5107
1"	Brass Plug	V5108

BRASS FITTINGS

1/4" x Close Brass Nipple	V5202
3/8" x Close Brass Nipple	V5204
1/4" x 1-1/2" Brass Nipple	V5203
1/4" Brass Threaded Tee	V5210
1/4" Brass Street Tee	V5211
1/4" Brass Coupling - Pipe Adapter	V5335
1/4" Brass Elbow (FPT x FPT)	V5209
1/4" Lock Nut	V5205
1/8" FPT Threaded Cap	V5220
1/4" FPT Threaded Cap	V5222

1/4" x 1/8" Reducer (MPT x FPT)	V5215
1/2" x 1/8" Reducer (MPT x FPT)	V5213
1/2" x 1/4" Reducer (MPT x FPT)	V5212
1/2" x 3/8" Reducer (MPT x FPT)	V5214
3/4" x 1/4" Reducer (MPT x FPT)	V5219
3/4" x 3/8" Reducer (MPT x FPT)	V5217
3/4" x 1/2" Reducer (MPT x FPT)	V5216
3/4" x 1/4" Swivel (Hose x MPT)	V5207
Quick Connector 1/4" Air (FPT x Snap)	V5336
Quick Connector 1/4" Air (MPT x Pin)	V5337

AIR RELIEF VALVES

1/8" Bleeder Valve - Brass	V4650
1/4" Bleeder Valve - Brass	V4651
1/4" Bleeder Valve - Plastic	V4652
1/8" Manual Lever Pet Cock - Brass	V7078
1/4" Manual Lever Pet Cock - Brass	V7079
1/4" Pet Cock - Brass (MPT x FPT)	V7076



COPPER PIPE FITTINGS

(Available in Springfield, Va. Only)

1-1/2"	Male Adapter w/Flo-Lock	U1181
2"	Male Adapter w/Flo-Lock	U1181
1/2"	Copper Male Adapter	
1"	Copper Male Adapter	V1810
1-1/2"	Copper Male Adapter	V1815
2"	Copper Male Adapter	V1820
1/2"	Copper Female Adapter	
1"	Copper Female Adapter	V1910
1-1/2"	Copper Female Adapter	V1915
2"	Copper Female Adapter	V1920
1/2"	Copper C x C Tee	
3/4"	Copper C x C Tee	
1"	Copper C x C Tee	V2310
1-1/2"	Copper C x C Tee	V2315
2"	Copper C x C Tee	V2320

Copper 90 degree Elbow	1/2"	
Copper 90 degree Elbow	1"	V2110
Copper 90 degree Elbow	1-1/2"	V2115
Copper 90 degree Elbow	2"	V2120
Copper 45 degree Elbow	1"	V2210
Copper 45 degree Elbow	1-1/2"	V2215
Copper 45 degree Elbow	2"	V2220
Copper C x C Coupling	3/4"	
Copper C x C Coupling	1"	V2010
Copper C x C Coupling	1-1/2"	V2015
Copper C x C Coupling	2"	V2020
Reducing Bushing	1-1/4" x 1-1/2"	V2026
Reducing Bushing	2" x 2-1/2"	V2025

All PVC prices are subject to fluctuations in the petroleum market which could result in constant price changing

SCH 40 UNIONS

		ITEM NO.
1/2"	SCH 40 Union S x S	U6600
3/4"	SCH 40 Union S x S	U6602
1"	SCH 40 Union S x S	U6604
1-1/4"	SCH 40 Union S x S	U6606
1-1/2"	SCH 40 Union S x S	U6608
2"	SCH 40 Union S x S	U6610
2-1/2"	SCH 40 Union S x S	U6618
3"	SCH 40 Union S x S	U6620
4"	SCH 40 Union S x S	U6622
1-1/2"	SCH 40 Union S x S (Hydro Air)	U6512
2"	SCH 40 Union S x S (Hydro Air)	U6513
3/4"	SCH 40 FPT x FPT Union	U6603
1-1/2"	SCH 40 FPT x FPT Union	U6612
2"	SCH 40 FPT x FPT Union	U6614
1-1/2"	SCH 40 MPT x F Slip Union	U6516
2"	SCH 40 MPT x F Slip Union	U6517
2"-1 1/2"	Reducing Union S x S	U6519

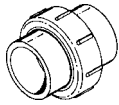





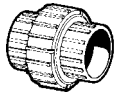



SCH 80 UNIONS

1/2"	SCH 80 Union S x S	U7706
3/4"	SCH 80 Union S x S	U7707
1"	SCH 80 Union S x S	U7710
1-1/4"	SCH 80 Union S x S	U7712
1-1/2"	SCH 80 Union S x S	U7715
2"	SCH 80 Union S x S	U7720
2-1/2"	SCH 80 Union S x S	U7725
3"	SCH 80 Union S x S	U7730
4"	SCH 80 Union S x S	U7740
3/4"	SCH 80 Union T x T	U7806
1-1/2"	SCH 80 Union T x T	U7815
2"	SCH 80 Union T x T	U7820
1-1/2"	SCH 80 CPVC Union S x S	U6715
2"	SCH 80 CPVC Union S x S	U6720
1-1/2"	SCH 80 CPVC Union T x T	U6717
2"	SCH 80 CPVC Union T x T	U6722



ABS UNIONS

SP1480	Double Male End Union 1-1/2" MPT x 1-1/2" MPT	 U6514
SP1481	1-1/2" Male Slip Union	 U6518
SP1484	Male/Female Union 1-1/2" MPT x 1-1/2" SKT	 U6515
SP1486	Double Male Union Elbow & Compression Fitting - 10"	 U6521
SP14952	Flush Union 1-1/2" FPT	 U7816
SP14952S	Flush Union 1-1/2" SKT	 U7822
SP14982S	Flush Union 2" SKT	 U7828
SP1491	Econo Union 1-1/4" MPT x 1-1/4" Smooth	 U5548
SP1492	Econo Union 1-1/2" MPT x 1-1/2" Smooth	U5549
SP1493	Econo Union 1-1/2" MPT x 1-1/2" Barb	 U5550
SP14461S	Union Check Valve 1-1/2" Socket	V1760
SP1500UNM	Union Connect 1-1/2" MPT	U7819
SP1500UNPAK1	Union Connector Pak	U7823
SP1500UNPAK2	Union Connector Pak	C1083

PVC CEMENT 10% off on Case Qty.

Regular

	CASE QTY.	ITEM NO.
PVC Cement - 1/4 Pint	24	V1000
PVC Cement - 1/2 Pint	24	V1001
PVC Cement - Pint	24	V1002
PVC Cement - Quart	24	V1003
PVC Cement - Gallon	6	V1005



Heavy Duty

H.D. Grey PVC Cement - Quart	12	V1004
H.D. Clear PVC Cement - Quart	12	V1008

ABS & All Purpose

ABS Cement - 1/2 Pint	24	V1007
All Purpose PVC Cement - Pint	24	V1006
Multipurpose PVC Cement - Pint	24	V1012
PVC to Flex Pipe Cement - Quart	12	V1027

Cold Weather

Polar-Weld PVC Cement - Quart	12	V1022
-------------------------------	----	-------

Blue PVC Cement wet weather application

Blue PVC Cement - Pint	24	V1026
Blue PVC Cement - Quart	12	V1017
Blue PVC Cement - Gallon	6	V1122



Empty Quart Can - New	V1060
Dauber - Replacement	V1065
Dauber - for "CanMate"	V1067
Cement Remover for Hands 16 Oz.	V1125
Cement Caddy (Holds 2 Qt. Cans)	V1070

PVC CLEANER

PVC Cleaner - 1/4 Pint	24	V1109
PVC Cleaner - 1/2 Pint	24	V1108
PVC Cleaner - Pint	24	V1110
PVC Cleaner - Quart	12	V1111
PVC Cleaner - Gallon	6	V1112



PVC PRIMER

Purple Primer - Pint	24	V1115
Purple Primer - Quart	12	V1118
Clear Primer - Quart	12	V1114
Pool-Tite Primer - Quart	12	V1020
Pool-Tite Primer - Gallon	6	V1124



RECTOR SEAL

Rector Seal #5 Thread Sealant - Pint	V1054
Rector Seal #5 Thread Sealant - Quart	V1056
Rector Seal T 2 Plus - Pint	V1050
Rector Seal T 2 Plus - Quart	V1052
Rector Seal "Better Bubble" - 8 Oz. Leak Locator	V7072

FLANGES

		ITEM NO.
1-1/2"	PVC Slip Flange	V1215
2"	PVC Slip Flange	V1220
2-1/2"	PVC Slip Flange	V1225
3"	PVC Slip Flange	V1230
4"	PVC Slip Flange	V1240
5"	PVC Slip Flange	V1250
6"	PVC Slip Flange	V1260
8"	PVC Slip Flange	V1280
10"	PVC Slip Flange	V1281



FLANGE GASKETS

Regular Thickness

			ITEM NO.
1-1/2"	Flange Gasket	3-7/8" Dia.	V1315
2"	Flange Gasket	5-3/4" Dia.	V1320
2-1/2"	Flange Gasket	6" Dia.	V1325
3"	Flange Gasket	6" Dia.	V1330
4"	Flange Gasket	7-1/2" Dia.	V1340
5"	Flange Gasket	8-1/2" Dia.	V1350
6"	Flange Gasket	9-1/2" Dia.	V1360
8"	Flange Gasket	11-3/4" Dia.	V1380



Extra Thick Gasket

3"	Flange Gasket (1/4" Thick Neoprene)	V1331
4"	Flange Gasket (1/4" Thick Neoprene)	V1341
5"	Flange Gasket (1/4" Thick Neoprene)	V1351
6"	Flange Gasket (1/4" Thick Neoprene)	V1361
8"	Flange Gasket (1/4" Thick Neoprene)	V1381

ASAHI PVC WAFER VALVES

2"	Asahi PVC Wafer Valve	V1400
2-1/2"	Asahi PVC Wafer Valve	V1402
3"	Asahi PVC Wafer Valve	V1404
4"	Asahi PVC Wafer Valve	V1406
5"	Asahi PVC Wafer Valve	V1408
6"	Asahi PVC Wafer Valve	V1410
8"	Asahi PVC Wafer Valve	V1412

ASTRAL PVC BUTTERFLY VALVES

2"	Astral PVC Butterfly Valve	V1550+
2-1/2"	Astral PVC Butterfly Valve	V1552
3"	Astral PVC Butterfly Valve	V1554
4"	Astral PVC Butterfly Valve	V1556
5"	Astral PVC Butterfly Valve	V1558
6"	Astral PVC Butterfly Valve	V1560
8"	Astral PVC Butterfly Valve	V1562

+Limited Stock

TVI PVC WAFER VALVES

2"	TVI Wafer Valve	V1501
2-1/2"	TVI Wafer Valve	V1502
3"	TVI Wafer Valve	V1503
4"	TVI Wafer Valve	V1504
5"	TVI Wafer Valve	V1505
6"	TVI Wafer Valve	V1506
8"	TVI Wafer Valve	V1508



FLANGE BOLTS & NUTS

Regular Type

		ITEM NO.
Flange Bolt	5/8" x 3"	V2630
Flange Bolt	5/8" x 3-1/2"	V2635
Flange Bolt	5/8" x 5"	V2650
Flange Bolt	5/8" x 5-1/2"	V2655
Flange Bolt	5/8" x 6"	V2657
Flat Washer	5/8"	V2680
Nut	5/8"	V2670
Flange Bolt	3/4" x 3"	V2730
Flange Bolt	3/4" x 3-1/2"	V2735
Flange Bolt	3/4" x 5"	V2750
Flange Bolt	3/4" x 5-1/2"	V2755
Flange Bolt	3/4" x 6"	V2760
Flange Bolt	3/4" x 7"	V2736
Flat Washer	3/4"	V2682
Nut	3/4"	V2672



See Appendix B on Page 294 for a complete Flange Bolt Chart

FLANGE BOLTS & NUTS

Stainless Steel

S.S. Flange Bolt	5/8" x 3"	V2631
S.S. Flange Bolt	5/8" x 3-1/2"	V2636
S.S. Flange Bolt	5/8" x 5"	V2651
S.S. Flange Bolt	5/8" x 5-1/2"	V2656
S.S. Flange Bolt	5/8" x 6"	V2658
S.S. Flange Bolt	5/8" x 7"	V2659
S.S. Flat Washer	5/8"	V2681
S.S. Nut	5/8"	V2671
S.S. Flange Bolt	3/4" x 3"	V2731
S.S. Flange Bolt	3/4" x 3-1/2"	V2737
S.S. Flange Bolt	3/4" x 5"	V2751
S.S. Flange Bolt	3/4" x 5-1/2"	V2756
S.S. Flange Bolt	3/4" x 6"	V2761
S.S. Flange Bolt	3/4" x 7"	V2762
S.S. Flat Washer	3/4"	V2683
S.S. Nut	3/4"	V2673

DOUBLE UNION BALL VALVES

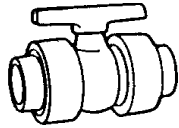

				ITEM NO.
1-1/2"	Astral	Double Union Ball Valve	S x S	V4058
2"	Astral	Double Union Ball Valve	S x S	V4060
2-1/2"	Astral	Double Union Ball Valve	S x S	V4062
3"	Astral	Double Union Ball Valve	S x S	V4064
4"	Astral	Double Union Ball Valve	S x S	V4066
1-1/2"	KBI	Double Union Ball Valve	S x S	V4355+
2"	KBI	Double Union Ball Valve	S x S	V4352+
3"	KBI	Double Union Ball Valve	S x S	V4350+
4"	KBI	Double Union Ball Valve	S x S	V4353+
1/2"	Praher	True Union Ball Valve	S x S	V4073
3/4"	Praher	Double Union Ball Valve	S x S	V4075
1"	Praher	True Union Ball Valve	S x S	V4077
3/4"	Praher	True Union Ball Valve	FIP x FIP	V4078
1"	Praher	True Union Ball Valve	FPTx FPT	V4079
1-1/2"	Praher	Double Union Ball Valve	S x S	V4080
2"	Praher	Double Union Ball Valve	S x S	V4082
2-1/2"	Praher	Double Union Ball Valve	S x S	V4084
3"	Praher	Double Union Ball Valve	S x S	V4086
2"	TVI	True Union Ball Valve	S x S	V1492
3"	TVI	True Union Ball Valve	S x S	V1496

BRONZE BALL VALVES

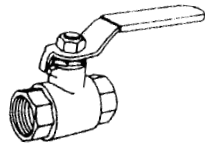

1/4"	Brass Ball Valve	T x T	V4301
3/4"	Bronze Ball Valve	T x T	V4306
1"	Bronze Ball Valve	T x T	V4308
1-1/2"	Bronze Ball Valve	T x T	V4305
2"	Bronze Ball Valve	T x T	V4310
1-1/2"	Bronze Ball Valve	C x C	V4304

BRONZE GATE VALVES

1/2"	Gate Valve	T x T	V1605
3/4"	Gate Valve	T x T	V1607
1"	Gate Valve	T x T	V1610
1-1/4"	Gate Valve	T x T	V1612
1-1/2"	Gate Valve	T x T	V1615
2"	Gate Valve	T x T	V1620
2-1/2"	Gate Valve	T x T	V1625
3"	Gate Valve	T x T	V1630
4"	Gate Valve	T x T	V1640
1"	Gate Valve	C x C	V1510
1-1/2"	Gate Valve	C x C	V1515
2"	Gate Valve	C x C	V1520

HOSE BIBS - MPT

1/2"	Brass Garden Hose Valve	F2173
3/4"	Brass Garden Hose Valve	F2174
3/4"	Plastic Garden Hose Valve	F2151



VALTERRA VALVES

1-1/2"	Valterra Valve	V4360
	S x S	
1-1/2"	Valterra Valve	V4361
	MPT x FPT Black	
1-1/2"	Valterra Valve	V4364
	w/Single Union	
2"	Valterra Valve	V4366
	w/Single Union	
2"	S x S Valve	V4362
3"	S x S Valve	V4367
4"	S x S Valve	V4368
6"	S x S Valve	V4369



VACUUM BREAKER

Vacuum Breaker
3/4" MGH x 3/4" FGH
Back Flow Preventor



V1525

SHOWER VALVES

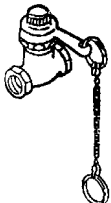

Pull Chain Shower Valve 1/2" V1535
Anti-Scald Shower Valve V1530
Quantity Discounts Available



STEEL WAFER VALVES

2"	Steel Wafer Valve (Harvard)	V1420+
2-1/2"	Steel Wafer Valve (Harvard)	V1425+

+Limited Stock

BALL VALVES

Single Entry Ball Valves

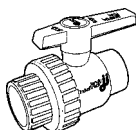
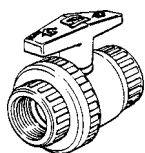

				ITEM NO.
1/2"	Spears	Single Union Ball Valve	S x S	V4005
3/4"	Spears	Single Union Ball Valve	S x S	V4007
1"	Spears	Single Union Ball Valve	S x S	V4010
1-1/4"	Spears	Single Union Ball Valve	S x S	V4012
1-1/2"	Spears	Single Union Ball Valve	S x S	V4015
2"	Spears	Single Union Ball Valve	S x S	V4020
2"	Spears	Single Union Ball Valve	T x T	V4021+
3"	Spears	Single Union Ball Valve	S x S	V4031
4"	Spears	Single Union Ball Valve	S x S	V4041
1-1/2"	Spears	Single Union Ball Valve	T x T	V4016
1-1/2"	Praher	Single Union Ball Valve	S x S	V4915
2"	Praher	Single Union Ball Valve	S x S	V4920
1-1/2"	Jandy	Single Union Ball Valve	S x S	V4116
2"	Jandy	Single Union Ball Valve	S x S	V4121
1-1/2"	Astral	Single Union Ball Valve	S x S	V4070
1-1/2"	FloControl	Ball Valve	S x S	V3115
2"	FloControl	Ball Valve	S x S	V3120

Lo-Torque PVC Ball Valves

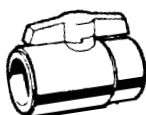

1/2"	Lo-Torque Ball Valve	S x S	V4343
3/4"	Lo-Torque Ball Valve	S x S	V4344
1"	Lo-Torque Ball Valve	S x S	V4345
1-1/4"	Lo-Torque Ball Valve	S x S	V4346+
1-1/2"	Lo-Torque Ball Valve	S x S	V4347
2"	Lo-Torque Ball Valve	S x S	V4348
3/4"	Lo-Torque Ball Valve	T x T	V4336

Compact PVC Utility Valves (Light Duty)

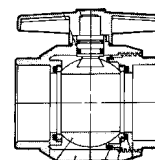

1/2"	Compact Utility Ball Valve	V4138
3/4"	Compact Utility Ball Valve	V4130
1"	Compact Utility Ball Valve	V4132
1-1/4"	Compact Utility Ball Valve	V4134
1-1/2"	Compact Utility Ball Valve	V4136
2"	Compact Utility Ball Valve	V4139

Non-Union Ball Valves



1/2"	Harvard PVC Ball Valve	S x S	V6600
3/4"	Harvard PVC Ball Valve	S x S	V6602
1"	Harvard PVC Ball Valve	S x S	V6604
1-1/4"	Harvard PVC Ball Valve	S x S	V6606
1-1/2"	Harvard PVC Ball Valve	S x S	V6608
2"	Harvard PVC Ball Valve	S x S	V6610
3/4"	Jandy Non-Union Ball Valve	V4207	
1"	Jandy Non-Union Ball Valve	V4210	
1-1/2"	Jandy Non-Union Ball Valve	V4215	
2"	Jandy Non-Union Ball Valve	V4220	

Hayward Ball Valves

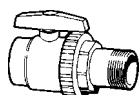

V4117

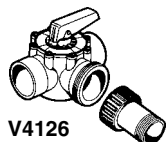

V4126

1-1/2"	Hayward PVC Ball Valve	SP0722S	S x S	V4111
2"	Hayward ABS Ball Valve	SP0724S	S x S	V4103
2"	Hayward Deluxe Ball Valve	SP0720		V4108+
1-1/2"	Hayward Diverter Valve (Perflex)	SP0727		V4114
1-1/2"	Hayward ABS Ball Valve	SP0723	MPT x FPT	V4118
1-1/2"	Hayward ABS Ball Valve	SP0723S	MPT x Slip	V4117
1-1/2"	Hayward ABS Trimline Ball Valve	SP0722	FPT	V4128
1-1/2"	Hayward ABS Ball Valve	SP0729	MPT x M Insert	V4532
1-1/2"	Deluxe 4-Way Ball Valve	SP0735S	S x S x S	V4125
1-1/2"	Dial-A-Flo 3-Way Valve	SP0733SM	SKT w/Male Nipple	V4126

+Limited Stock



JANDY VALVES DIVERTER VALVES

NeverLube Jandy Valve



		ITEM NO.
1-1/2" & 2"	2-Way NeverLube Jandy Valve	V4594
2" & 2-1/2"	2-Way NeverLube Jandy Valve	V4592
1-1/2" & 2"	3-Way NeverLube Jandy Valve	V4542
2" & 2-1/2"	3-Way NeverLube Jandy Valve	V4591
	Never Lube Diverter Replacement Kit	V4590

Standard Jandy Valve

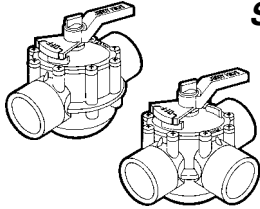

1-1/2" & 2"	2-Way Positive Seal Jandy Valve	V4548
2" & 2-1/2"	2-Way Positive Seal Jandy Valve	V4543
1-1/2" & 2"	3-Way Positive Seal Jandy Valve	V4547
2" & 2-1/2"	3-Way Positive Seal Jandy Valve	V4544
	Lube Kit for Positive Seal Valves	H8053

Space Saver Valve

1-1/2" & 2"	Jandy 3-Port Space Saver Valve	F7137
-------------	--------------------------------	-------

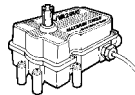

Actuator Motor

Actuator Only 24 Volt	JVA 2440	V4578
Micro Switch	JVA 3659	V4529

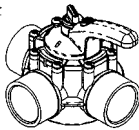

HAYWARD PSV DIVERTER VALVES

1-1/2" & 2"	2-Way Hayward PSV2S Valve	V4230
2" & 2-1/2"	2-Way Hayward PSV2S2 Valve	V4232
1-1/2" & 2"	3-Way Hayward PSV3S Valve	V4234
2" & 2-1/2"	3-Way Hayward PSV3S2 Valve	V4236

Intermatic Valves

1-1/2" & 2"	2- Way CPVC Valve	V4534
2" x 2 1/2"	2- Way CPVC Valve	V4538
1-1/2" x 2"	3- Way CPVC Valve	V4536
2" x 2 1/2"	3- Way CPVC Valve	V4539

PENTAIR VALVES



"New" Compool Never Lube Valve



1-1/2" & 2"	2-Way Compool Never Lube Valve (Schd 40)	V3166
2" & 2-1/2"	2-Way Compool Never Lube Valve (Schd 40)	V3156
1-1/2" & 2"	3-Way Compool Never Lube Valve (Schd 40)	V3164
2" & 2-1/2"	3-Way Compool Never Lube Valve (Schd 40)	V3154

Actuator Motor for Compool Valve	V4731
----------------------------------	-------

PRAHER DIVERTER VALVES



2"	2-Port Perma Seal Valve	V4942
1-1/2"	3-Port Perma Seal Valve	V4935
2"	3-Port Perma Seal Valve	V4940
1-1/2"	3-Port Perma Seal Valve - Unionized	V4925
2"	3-Port Perma Seal Valve - Unionized	V4930
3"	3-Port Perma Seal Valve - Unionized	V4950

HAYWARD CHECK VALVES

ITEM NO.

1-1/2" Hayward Union Check Valve	S x S	SP14461S	V1760
1-1/2" Hayward Union Check Valve	MPT x FS	SP14462S	V1762+
1-1/2" Hayward Check Valve - Tee	Socket	SP1445S	V1767+

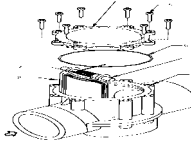

JANDY - CPVC CHECK VALVES

1-1/2" & 2" Jandy Check Valve, High Flow, w/ Clear Top	V4557
2" & 2-1/2" Jandy Check Valve, High Flow, w/ Clear Top	V4558
1-1/2" & 2" Jandy 90 Degree Swing Check Valve	V4554
2" & 2-1/2" Jandy 90 Degree Swing Check Valve	V4559

PENTAIR - CPVC CHECK VALVES

2" & 1-1/2" Pentair Check Valve (Straight)	V3176*
--	--------

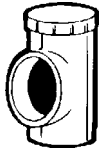

ORTEGA CHECK VALVES

1-1/2" Ortega 90 Degree Spring Check Valve 1 Lb.	V3075
2" Ortega 90 Degree Spring Check Valve 1 Lb.	V3076

PVC SWING CHECK VALVES

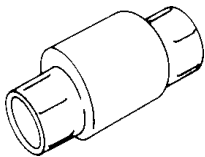

1/2" PVC Swing Check Valve	S x S	V4374
3/4" PVC Swing Check Valve	S x S	V4376
1" PVC Swing Check Valve	S x S	V4378
1-1/2" PVC Swing Check Valve	S x S	V3055
1-1/2" KBI Spring Check Valve Clear w/Unions		V4373
2" PVC Swing Check Valve	S x S	V3060
3" PVC Swing Check Valve	S x S	V3065
4" PVC Swing Check Valve	S x S	V3070
1-1/2" PVC Swing Check Valve Compression		V1765
2" PVC Swing Check Valve Compression		V1766
2" PVC Swing Check Valve Clear S x S		V3061
3" PVC Swing Check Valve Clear w/ Unions		V3066
4" PVC Swing Check Valve Clear w/ Unions		V3071

PVC SPRING CHECK VALVES

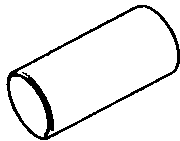

1-1/2" PVC Spring-Loaded Check Valve	S x S	1/2 Lb.	V3010
1-1/2" PVC Spring-Loaded Check Valve	T x T	1/2 Lb.	V3015
2" PVC Spring-Loaded Check Valve	S x S	1/2 Lb.	V3020
1-1/2" PVC Spring-Loaded Check Valve	S x S	2 Lb.	V3000
1-1/2" PVC Spring-Loaded Check Valve	T x T	2 Lb.	V3005+
2" PVC Spring-Loaded Check Valve	S x S	2 Lb.	V3022
2" In-Line PVC Spring-Loaded Check Valve	S x S	1/2 Lb.	V4370+
2" In-Line PVC Spring-Loaded Bypass Valve	S x S	5 Lb.	V4372



BRONZE CHECK VALVES

1" Bronze Check Valve	T x T	V1714
1-1/2" Bronze Check Valve	T x T	V1715
2" Bronze Check Valve	T x T	V1720
2-1/2" Bronze Check Valve	T x T	V1722
4" Bronze Check Valve	T x T	V1740
1-1/2" Bronze Check Valve	C x C	V1745
2" Bronze Check Valve	C x C	V1750

PRAHER CHECK VALVES

DOUBLE UNION W/ 2 LB TEFLON COATED SPRING

1-1/2" Check Valve	V4948
2" Check Valve	V4945

+Limited Stock
*Non-Stock Items

COMPRESSION COUPLING

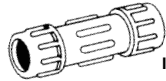

		ITEM NO.
1-1/2"	Compression Coupling	U4215
2"	Compression Coupling	U4220
2-1/2"	Compression Coupling	U4225
3"	Compression Coupling	U4230
4"	Compression Coupling	U4240
6"	Compression Coupling	U4245

COMPRESSION UNION ADAPTER

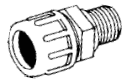

1-1/2"	Union Adapter	U4250
2"	Union Adapter	U4252

QUIK-FIX REPAIR COUPLINGS

Slip X Spigot



1-1/2"	Quick-Fix Coupling	U4216
2"	Quick-Fix Coupling	U4221
2-1/2"	Quick-Fix Coupling	U4226
3"	Quick-Fix Coupling	U4231
4"	Quick-Fix Coupling	U4241

KWIK REPAIR COUPLINGS

Sleeves Telescope Onto the Pipe

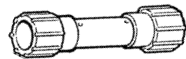

1"	Kwik Repair Coupling	U4273
1-1/2"	Kwik Repair Coupling	U4270
2"	Kwik Repair Coupling	U4272
2-1/2"	Kwik Repair Coupling	U4275
3"	Kwik Repair Coupling	U4274
4"	Kwik Repair Coupling	U4276
1-1/2"	Kwik Repair Tee	U4277
2"	Kwik Repair Tee	U4278

MISSION COUPLINGS



3/4"	Mission Coupling - PVC	F1309
1"	Mission Coupling - PVC	F1310
1-1/4"	Mission Coupling - PVC	F1300
1-1/2"	Mission Coupling - PVC	F1301
2"	Mission Coupling - PVC	F1302
3"	Mission Coupling - PVC	F1304
4"	Mission Coupling - PVC	F1308
2" x 1-1/2"	Mission Coupling - PVC	F1303
3" x 2"	Mission Coupling - PVC	F1306
4" x 3"	Mission Coupling - PVC	F1314
1-1/2"	PVC x 1-1/2" Copper	F1305
1-1/2"	Mission Coupling - Copper	F1300
2"	Mission Coupling - Copper	F1307

Flo 1-1/2" IPS Socket x 1-1/2" CTS	V3016
<i>Copper to PVC w/Flo Lock Adapter</i>	
Flo 2" IPS Socket x 2" CTS	V3021
<i>Copper to PVC w/Flo Lock Adapter</i>	

PVC PIPE EXTENDERS

		ITEM NO.
1/2"	PVC Pipe Extender	U8692
3/4"	PVC Pipe Extender	U8693
1"	PVC Pipe Extender	U8694
1-1/2"	PVC Pipe Extender	U8695
2"	PVC Pipe Extender	U8696
2 1/2"	PVC Pipe Extender	U8700
3"	PVC Pipe Extender	U8697
4"	PVC Pipe Extender	U8698

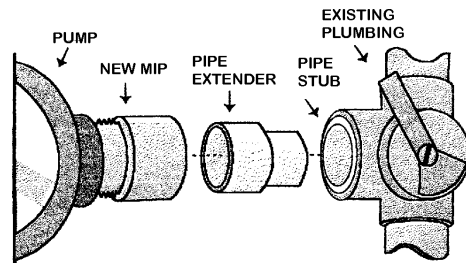

PVC FITTING EXTENDER

*No Measuring - Always Fits
Pipe goes in one end - other end goes in fitting*

3/4"	PVC Fitting Extender	U8707
1"	PVC Fitting Extender	U8710
1-1/2"	PVC Fitting Extender	U8715
2"	PVC Fitting Extender	U8720

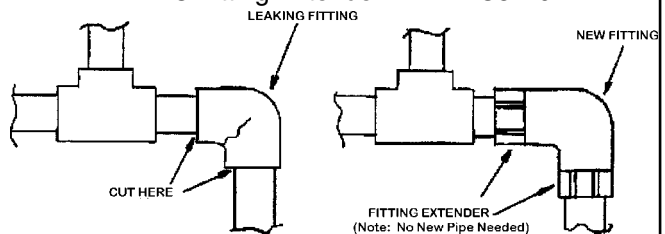

INSIDE PIPE COUPLINGS

1-1/2"	Inside Pipe Coupling	U8725
2"	Inside Pipe Coupling	U8727
3"	Inside Pipe Coupling	U8690
4"	Inside Pipe Coupling	U8689

PVC REPAIR COUPLINGS

Flo Span

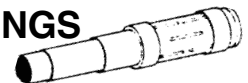

3/4"	Expansion Repair Coupling	V4380
1"	Expansion Repair Coupling	V4382
1-1/2"	Expansion Repair Coupling	V4384
2"	Expansion Repair Coupling	V4386
2-1/2"	Expansion Repair Coupling	V4388
3"	Expansion Repair Coupling	V4389
4"	Expansion Repair Coupling	V4390

LEAK REPAIR - Rigid & Flex PVC Pipe

1/2"	Snap On Seal	U8680+
3/4"	Snap On Seal	U8682+
1-1/2"	Snap On Seal	U8686+



+Limited Stock

CLOSED TEST PLUGS

	ITEM NO.
3/4" Closed Test Plug <i>for 3/4" Pipe</i>	V5648
15/16" Closed Test Plug <i>for 1" Pipe & 3/4" Fitting</i>	V5650
1-1/4" Closed Test Plug <i>for Pipe & 1" Fitting</i>	V5652
1-3/8" Closed Test Plug <i>for 1-1/2" MTA/Copper Pipe</i>	V5654
1-1/2" Closed Test Plug <i>for 1-1/2" Pipe</i>	V5653
1-5/8" Closed Test Plug <i>for 1-1/2" Threads</i>	V5655
1-3/4" Closed Test Plug <i>for 1-1/2" Socket</i>	V5651
1-7/8" Closed Test Plug <i>for 2" Pipe</i>	V5656
2-1/8" Closed Test Plug <i>for 2" Fitting</i>	V5657
2-1/4" Closed Test Plug <i>for 2" Socket & 2-1/2" Pipe</i>	V5658
2-1/2" Closed Test Plug <i>for 2-1/2" Pipe & Threads</i>	V5659
2-3/4" Closed Test Plug <i>for 2-1/2" Socket</i>	V5660
3" Closed Test Plug <i>for 3" Pipe & Threads</i>	V5665
3-1/4" Closed Test Plug <i>for 3" Socket</i>	V5666
3-1/2" Closed Test Plug <i>for 4" Pipe</i>	V5670
4" Closed Test Plug <i>for 4" Fitting</i>	V5671



OPEN TEST PLUGS

1/8" pipe thread & 3/8" hose barb on top allows introduction of air through 1/4" hole for testing

	ITEM NO.
1" Open Test Plug	V5610
1-1/4" Open Test Plug <i>Fits Pipe</i>	V5612
1-3/8" Open Test Plug <i>For Male Adapter</i>	V5613
1-1/2" Open Test Plug	V5615
1-5/8" Open Test Plug	V5616
1-7/8" Open Test Plug	V5620
2-1/8" Open Test Plug	V5621
2-1/2" Open Test Plug	V5625
2-3/4" Open Test Plug	V5630
3" Open Test Plug	V5635
3-1/2" Open Test Plug	V5640
4" Open Test Plug	V5641



RUBBER TEST PLUGS

Rubber Inflatable Test Plug 1-1/2"	V5500
Rubber Inflatable Test Plug 2"	V5502
Rubber Inflatable Test Plug 3"	V5504
Rubber Inflatable Test Plug 4"	V5506
Rubber Inflatable Test Plug 6"	V5508
Rubber Inflatable Test Plug 8"	V5509
Test Pump with Gauge	V5510
Extension Hose - 2'	V5512
Extension Hose - 3'	V5514
Extension Hose - 20'	V5516



CLOSED TEST PLUGS

Plastic

1-1/2" Closed Test Plug - Plastic	V5416
2" Closed Test Plug - Plastic	V5421
3" Closed Test Plug - Plastic	V5431
4" Closed Test Plug - Plastic	V5441
6" Closed Test Plug - Plastic	V5460
8" Closed Test Plug - Plastic	V5480



Red

1-1/4" Red Closed Test Plug	V5410
1-1/2" Red Closed Test Plug	V5415
2" Red Closed Test Plug	V5420
3" Red Closed Test Plug	V5430
4" Red Closed Test Plug	V5440

TIRE VALVES

Attaches to Above Open Test Plugs 1/8" FPT x AIR	V5645
--	-------



EXPAND & PURGE WINTER PLUGS

#7 Winter Plug w/ Purge 1-1/4"	V5300
#8 Winter Plug w/ Purge 1-3/8"	V5302
#9 Winter Plug w/ Purge 1-1/2"	V5304
#10 Winter Plug w/ Purge 2"	V5306
#11 Winter Plug w/ Purge 2"	V5308



PRESSURE TEST RIGS

Air Pressure Test Manifold with Gauge <i>Attaches to Air Chuck</i>	V5228
Water Pressure Test Manifold with Gauge <i>Attaches to Garden Hose</i>	V5230

LENOX SAWS & BLADES

No Return Policy on All Tools



Pipe Saws

- Lenox 12" PVC/ABS Plastic Pipe Saw
- Lenox 18" PVC/ABS Plastic Pipe Saw



- ITEM NO.
V7036
V7037

Replacement Blades

- Lenox 12" Replacement Pipe Saw Blade
- Lenox 18" Replacement Pipe Saw Blade

- V7038
V7039

Reciprocating Blades



- Lenox Reciprocating Blade (6" x 3/4" x .050) 10T
- Lenox Reciprocating Blade (6" x 3/4" x .050) 14T
- Lenox Reciprocating Blade (6" x 3/4" x .050) 24T
- Lenox Reciprocating Blade (9" x 1" x .042) 24T
- Lenox Gold Reciprocating Blade (9" x 7/8" x .062) 24T
- Lenox Reciprocating Blade (12" x 3/4" x .050) 10/14T
- Lenox Reciprocating Blade (12" x 3/4" x .050) 6T

- V7360
V7362
V7364
V7356
V7358
V7366
V7368

Flush Cut Blade Adaptor

- Lenox Flush Cutting Blade Adaptor

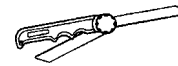

- V7043

Tri-Fold Saw

- Lenox 3-Position Tri Fold Saw

- V7041

RAMBIT

*Removes plastic pipe from plastic fitting
Leaves fittings clean & ready for solvent welding*

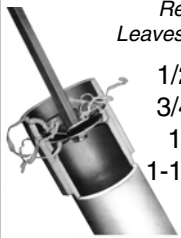

- 1/2" Ram Bit - Complete V7405
- 3/4" Ram Bit - Complete V7407
- 1" Ram Bit - Complete V7410
- 1-1/2" Ram Bit - Complete V7415
- Replacement Blade V7416
- 2" Ram Bit - Complete V7420
- Replacement Blade V7421

INSIDE PIPE CUTTERS

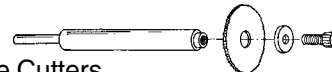

- Inside Pipe Cutters V7335
- Blade Only- 1-1/2" to 2" V7336
- Blade Only- 3" to 6" V7337
- Pipe Cutter - L Spring V7029

PVC WIRE SAWS

- Wire Saw V7208
- Heavy Duty Wire Saw V7209
- Quick Saw Replacement Cable V7211



PVC PIPE CUTTER

- PVC Pipe Cutter Up to 2" V7017
- PVC Pipe Cutter Up to 1-1/4" V7019
- Replacement Blades V7018



HACK SAW

- Hack Saw - MZ208 V7235
- Replacement Blade #110 V7241

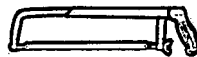

TUBING CUTTER



- Up to 2" V7013

UTILITY KNIFE

- With Retractable Blade V7246
- 16 Piece Universal Repl. Blades V7245



CONCRETE SAW BLADES

- Concrete Saw Blades 4" (Segmented) T1650
- Concrete Saw Blades 4" (Turbo Cut) T1652
- Concrete Saw Blades 7" (Turbo Cut) T1656
- Concrete Saw Blade 4" (3/8" V-Cut) T1654
"Crack Chaser"
- Concrete Saw Blade 12" (Carbide) T1655
1/8" thick x 1" arbor
- Hand Sanding Pad Holder 4" T1660
- Backing Pad 5" T1668
- Diamond Polishing Disc 5" T1666

DRILL BITS

Spline Shank Quad Style



- Drill Bit 3/4" x 13" V7106
- Drill Bit 3/4" x 18" V7102
- Drill Bit 3/4" x 21" V7108
- Drill Bit 3/4" x 23" V7104
- Drill Bit 7/8" x 13" V7110



SCREWDRIVER

	ITEM NO.
4-In-One Screwdriver	V7030+
6-In-One Screwdriver	V7031

+Limited Stock

PLIERS

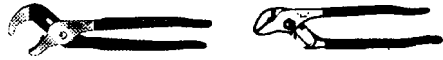

10" Channel Lock Pliers (2" Cap)	V7212
16" Channel Lock Pliers (4-1/4" Cap)	V7214
12" Channel Lock Pliers (GripLock)	V7222
10" Water Pump Pliers	V7215
12" Water Pump Pliers	V7220

HANDRAIL



Stabilizing Plug w/ Handrail <i>Carbon Fiber</i>	V7200
Stabilizing Plug w/ Handrail <i>Aluminum</i>	V7207

RAIL PULLER

Lift Rail Out of Socket	V7210
-------------------------	-------

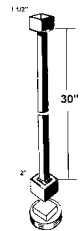

CLEAN-OUT PLUG REMOVER	
Clean-Out Plug Remover	V7090
<i>Steel wrench - 30" long</i>	
Hydrostatic Valve Wrench	V7305
<i>Use w/V7090 to Remove Hayward SP1056</i>	

LID REMOVING TOOLS



Dura-Grip Wrench	N1198
<i>Multipurpose Lid Opening Tool. Fits Hayward, Pac-Fab, Sta-Rite & More</i>	
Hayward SP-3100-T	K4427
Sta-Rite Lid Wrench	V7089
Dura Glas Pump Lid Wrench	K3258

**EYEBALL
SEAT REMOVER**



N1193

**ADJUSTABLE
STRAP WRENCH**



V7228

**HEATER ELEMENT
WRENCH**



V7450

**SPANNER WRENCH
for Flo Control Fittings**

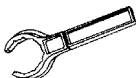

1-1/2"	Flo Spanner Wrench	U4255
2"	Flo Spanner Wrench	U4260

PIPE TAPS



	ITEM NO.
1/8" Pipe Tap	V7370
1/4" Pipe Tap	V7372
3/8" Pipe Tap	V7373
1/2" Pipe Tap	V7374
3/4" Pipe Tap	V7376
1" Pipe Tap	V7378
1/4" Drill Tap/Combo	V7385

WINGMASTER PLUS

*All-in-one tool
for pool technicians*

Wingmaster Plus Tool	V7224
Wingmaster Plus Service Kit	V7225
Wingmaster Anchor Shell	V7223
Wingmaster Plus Wood Anchor	V7227
Wingmaster Wing Bar	V7231
Wingmaster Plus Radius Template	V7237
Wingmaster Pipe Deburr Tool	V7238
Wingmaster "JS" Hardened Tool	V7242
Wingmaster "CN" Castle Nut	V7243
Wingmaster "MHK" Hand Knob Extractor Kit	V7244
Wingmaster OTRB 1.5" Rep Blade	V7248
Wingmaster OTRB 2" Rep Blade	V7249



AQUA WRENCHES

EyeBall Seat Removal Tool	 V7300
Polaris/Letro UWF Removal Tool	 V7302
Hydro Static Valve Removal Tool	 V7304

**ACID DRUM
WRENCH**



V7073

**CARBOY CAP
WRENCH**

V7074



ALLEN WRENCH

1/8" Tee Handle

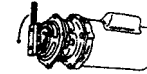

V7080

IMPELLER WRENCHES

V7205 	Open Impeller Wrench	V7205
 V7206	Closed Impeller Wrench	V7206

IMPELLER WEDGE

Impeller Wedge

V7204

Designed especially for spa booster pumps

SHAFT SEAL TOOL

Sta-Rite Shaft Seal Tool	K3240
Pool Tool #100 Shaft Puller	V7203

MAIN DRAIN MAT

V7202

TROWELS & FLOATS

No Return Policy On All Tools

Pool Trowels
with California Handles

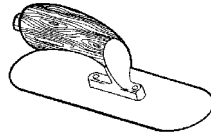

Margin Trowel

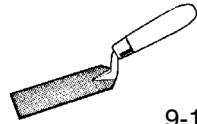

Grout & Tile Floats
Hardwood Handle & Metal Back

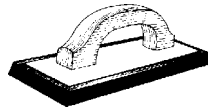

		ITEM NO.
3" x 10"	Stainless Steel Pool Trowel	V7000
3-1/2" x 12"	Stainless Steel Pool Trowel	V7001
4" x 14"	Stainless Steel Pool Trowel	V7002
5" x 18"	Stainless Steel Pool Trowel	V7004
3" x 10"	Blue Steel Pool Trowel	V7008
4" x 10"	Blue Steel Pool Trowel	V7009
5" x 18"	Blue Steel Pool Trowel	V7010
2" x 5"	Margin Trowel	V7005
9-1/2" x 4" x 5/8"	Fine Rubber Float	V7006
12" x 4-1/4"	Neoprene Float	V7007
	Grout Clean-up Scrubber	V7290
	Grout Detail Sponge	V7292

LEAK DETECTION

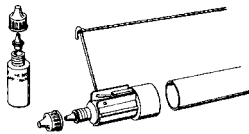

Leak Detector #151



Dye Tester Syringe

Tester Syringe with - Dark Blue Color	V4912
Anderson 8oz Dye Refill Blue	V4911
Tester Syringe with Fluorescent Color	V4914
Anderson 8oz Refill - Florescent Color	V4913

Uranine Dye

Water Circulation & Leak Test 1 Lb. Jar	V4902
---	-------

Leak Detector #151

Red Dye	V4905
Replacement Solution for Leak Detector	V4910

Rectorseal "Better Bubble"

Gas Line Leak Detector	V7072
------------------------	-------

Geophone

Leak Finding Stethoscope w/Case	V7082
---------------------------------	-------

Electronic Geophone XLT-17

V7083* Special Order Item

ELECTRICAL TAPE

Roll Black Electrical Tape K5140

DUCT TAPE

Roll Duct Tape R1085
2" x 60 Yd 24/Case



MASKING TAPE

Roll Masking Tape R1090
2" x 60 Yd 24/Case



CORD & HOSE HOLDERS

Velcro Strap F1125
For Carrying Electrical Cord or Vac Hose



Hose Hugger for Pool & Vacuum F1126
Power Cord Holder - Up to 200' O1198

HOSE & CORD REEL

Hose & Cord Reel F1145

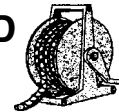

PIPE HANGER

3/4" x 10" V7280





GIANT LEAF BASKET

ITEM NO.

Optional Sand Trap System

STS-2

S4716*

Converts Giant Leaf Basket into a Sand Trap System to easily remove 250 Lbs. of sand. Includes all hoses, fittings, plate & conversion kit.



*Non-Stock Item

ACID DRUM SYPHON PUMP

Acid Drum Syphon Pump
Acid Drum Spigot



ITEM NO.

V7055

V7059

SAND-VAC

H4095

Empties a sand filter in 10 minutes
Both quick & easy. Pays for itself in labor savings. Fits most brand filters

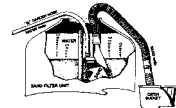

AIR COUPLER

1/4" Brass Air Coupler
Male End Only for Coupler

V5336

V5337

MANOMETER

Dwyer 15" Hydroguage
For testing gas pressure

V7015

CLEANING WAND

Master Blaster Filter Cleaning Wand H6026
Jet Action Cleaning Wand H6027



Attaches to garden hose to clean grids & cartridges

O-RING KITS

Aladdin P.R.O. Box 1



S4140

Box of 36 small O-rings & gaskets w/over 300 applications along w/lube & switches



Box of 380 O-Rings

S4135

Pro Box 1 O-Ring Kit

S4140

O-Ring Making Kit

S4130

DRAIN KING

Drain King
for unclogging pipes

V7075

PLASTIC SCOOPS



E-Z Chemical Scoop

A6048

D.E. Scoop Hayward

H6139

Flat Edge 3 Qt. Scoop

V7057

DRY BED

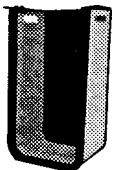

Dry Works II
31" deep x 20" wide

S4702*

*Non-Stock Item

Allows for wall fitting & skimmer repair without lowering water level

SUCTION MAT

Main Drain Suction Mat V7202

▶▶	SOLAR	FILTER	SPA SUCTION PUMP	P O O L F I L L
▶▶	SOLAR	BACK WASH	SPA RETURN PUMP	
▶▶	HEATER	FILTER	SPA PUMP PUMP	
▶▶	HEAT	BACK WASH	POOL PUMP AIR	
▶▶	INTAKE	SKIMMER	POOL PUMP TO	
▶▶	FLOOR	SKIMMER	POOL RETURN FROM	
▶▶	FLOOR	RETURN	POOL SUCTION POOL	
▶▶	CLEANER	RETURN	SPA BYPASS SPA	
▶▶	CLEANER	SUCTION	SPA JETS SPA	
▶▶	SYSTEM	SUCTION	SLIDE SPA	
1 2	WATER FALL	WATER FEATURE	MAIN DRAIN	

PLUMBING LABELS

Easy Identification for your Pool or Spa Plumbing

Complete Set of Plumbing

H7146

Layout Labels - Peel & Stick

Individual Equipment Labels

Each

Large 2" x 3" Size

MAIN DRAIN



SKIMMER

Available: "Pool Cleaner", "Backwash", "Main Drain", "Skimmer", "Vacuum", "Spa" & "Return"

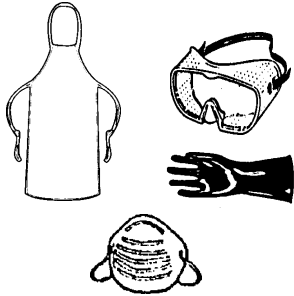

Chemical Apron	for Handling Hazardous Materials <i>Polyethylene Coated</i>	V7049
Chemical Apron	Neoprene	V7053
Safety Goggles	Clear Safety Goggles <i>Edge Seal Fits with or without Glasses</i>	V7052
Rubber Gloves	for Handling Hazardous Material	V7051
Dust Masks	Disposable Dust Mask (50/Box)	V7048
	NonToxic Dust Mask	V7058
	3M #8576 Particulate Respirator with Acid Gas Relief	V7050

Work Gloves

			ITEM NO.	
A	Disposable Latex Gloves (100/Box)		V7086	
B	Black Plastic Dot Canvas Gloves		V7088	
C	Jersey Work Gloves		V7091	
	Lined Jersey Work Gloves		V7094	
D	Light Duty Leather Gloves		V7092	
E	H.D. Leather Palm Gloves		V7093	
F	H.D. Welder's Gloves		V7095	
	Vinyl Palm (Cotton Back) Gloves	Red	V7097	Blue V7098
	Vinyl Palm Gloves - Blue H. Duty		V7099	
	26" Stay Dry Gloves	Large	V7045	XL V7046

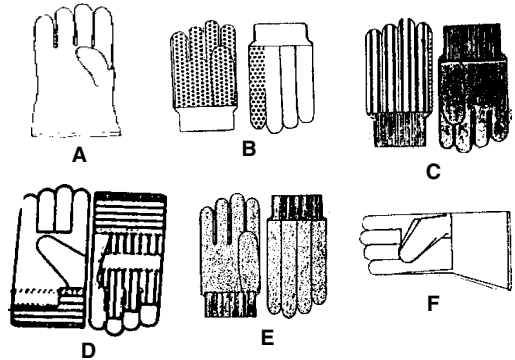

Knee Pads	Deluxe Knee Pads	V7012
------------------	------------------	-------

Rainsuits



Rainsuit - PVC	2-Piece	Small	V7160
Rainsuit - PVC	2-Piece	Medium	V7162
Rainsuit - PVC	2-Piece	Large	V7164
Rainsuit - PVC	2-Piece	X-Large	V7166
Rainsuit - PVC	2-Piece	XX-Large	V7168
Vinyl Rainsuit 2-Piece		Small	V7140+
Vinyl Rainsuit 3-Piece	(Detachable Hood)	Medium	V7141+

+Limited Stock

Hip Boots

Rubber 3/4 Hip Boots	Size 8	V7130+
Rubber 3/4 Hip Boots	Size 9	V7131+
Rubber 3/4 Hip Boots	Size 11	V7133+
Rubber 3/4 Hip Boots	Size 12	V7134+
Rubber 3/4 Hip Boots	Size 13	V7135+

+Limited Stock

Slush Boots

Slush Boot	Size 9	V7188
Slush Boot	Size 10	V7182
Slush Boot	Size 11	V7180
Slush Boot	Size 12	V7184
Slush Boot	Size 13	V7186



Knee Boots

Size 7	w/White Soles	NEW	V7119W
Size 8	w/Black Soles		V7120
Size 8	w/ White Soles		V7120W
Size 9	w/Black Soles		V7121
Size 9	w/ White Soles		V7121W
Size 10	w/Black Soles		V7122
Size 10	w/ White Soles		V7122W
Size 11	w/Black Soles		V7123
Size 11	w/ White Soles		V7123W
Size 12	w/Black Soles		V7124
Size 12	w/ White Soles		V7124W
Size 13	w/Black Soles		V7125
Size 13	w/White Soles		V7125W

Over Shoe Boots

Size 11	2 Buckle	V7170
---------	----------	-------

SR OPTICOAT LOW VOC SYNTHETIC RUBBER



Opticoat is the same quality, synthetic rubber-base enamel as Optilon.

POXOLON EPOXY PAINT



A high gloss epoxy pool coating that's easy to apply & lasts about five years. Use with primer. Two finish coats are required.

Coverage 225 - 250 Sq. Ft.

ZERON EPOXY PAINT



A one coat epoxy which should last at least 8 years. High solids epoxy covers stains and seals hairline cracks. Smooth surface.

Coverage 125 - 150 Sq. Ft.

HYDROLON WATER BASE ACRYLIC



Acrylic enamel for use on bare concrete or plaster and old rubber base finish. Can be applied to damp surfaces. Two coats required.

Coverage 250 - 300 Sq. Ft.

POXOPRIME II EPOXY PRIMER



For application over unpainted concrete or plaster. Seals surfaces & reduces downtime. Compatible with wet surfaces.

Coverage 200 - 250 Sq. Ft.

PATIO TONES DECK COATING



A non-slip, deck & patio coating useful for covering older decks that have become stained & worn. Water base formula.

Coverage 90 - 125 Sq. Ft.

Not All Items Stocked

Kelley Technical Coatings

Paralon 2 Rubber Base

Blue Ice Paralon 2	1 Gal. Pail	291	ITEM NO. Q1010+
--------------------	-------------	-----	--------------------

Opticoat Low VOC Sythetic Rubber- Paint

White	1 Gal. Pail	280	Q2030
White	5 Gal. Pail	280	Q2035
Blue Ice	1 Gal. Pail	282-1	Q2040
Blue Ice	5 Gal. Pail	282-5	Q2045
Bikini Blue	1 Gal. Pail	283-1	Q2050
Bikini Blue	5 Gal. Pail	283-5	Q2055
Black	1 Gal. Pail	284-1	Q2060

Fusion Plus - Converts Rubber Base Pools to Epoxy

White	1 Gal. Pail	260	Q1079
-------	-------------	-----	-------

Poxolon Epoxy Paint

White Poxolon	1 Gal. Pail	222	Q1035+
Black Poxolon	1 Gal. Pail	226	Q1065+

Zeron Epoxy Paint

White Zeron	1 Gal. Pail	390	Q1070
White Zeron	5 Gal. Pail	390	Q1075
Bikini Blue	1 Gal. Pail	392	Q1072
Bikini Blue	5 Gal. Pail	392	Q1078
Black	1 Gal. Pail	399	Q1073
Blue Mist	1 Gal. Pail	395	Q1071
Blue Mist	5 Gal. Pail	395	Q1076
Blue Ice	5 Gal. Pail	391	Q1077
Blue Ice	1 Gal. Pail	391	Q1080

Hydrolon Water Base Acrylic

White Hydrolon	1 Gal. Pail	710	Q5010+
Bikini Blue Hydrolon	1 Gal. Pail	713	Q5030+
Black Hydrolon	1 Gal. Pail	717	Q5040+

Poxoprime II Primer

Poxoprime II	1 Gal. Pail	214	Q5001
--------------	-------------	-----	-------

Gunzite Epoxy Primer

Undercoat for rough plaster or concrete

Gunzite Epoxy Primer	1 Gal. Pail	216	Q7010
	5 Gal. Pail	216	Q7015

Bonderite Epoxy Primer

Undercoat for bare aluminum

Bonderite Epoxy Primer	1 Gal. Pail	215	Q7005
------------------------	-------------	-----	-------

Steel Primer

For bare steel pool surfaces

Steel Primer	1 Gal. Pail	219	Q5002
--------------	-------------	-----	-------

Galvanized Steel Primer

For galvanized steel surfaces

Galvanized Steel Primer	1 Gal. Pail	220	Q5004
-------------------------	-------------	-----	-------

Biturez

One coat epoxy paint for interior of filter tanks

Biturez Black Epoxy	1 Gal. Can	965	Q7000
---------------------	------------	-----	-------

Olympic PRIMERS

SOLVENTS

Solvent for Rubber Base	1 Gal. Can	1108	Q6000
Solvent for Epoxy Paint	1 Gal. Can	1109	Q6010

PATIO TONES

Aztec Brown	1 Gal.	Q3022	Desert Sun	1 Gal.	Q3005
Coral	1 Gal.	Q3025	Sage Green	1 Gal.	Q3000
Creekstone	1 Gal.	Q3015	Sand Valley	1 Gal.	Q3010
			Smokey Blue	1 Gal.	Q3020

FRONTIER DESERT DECK

Regular Sand Buff	1 Gal. Pail	T1601
Kool Deck Dash Brush		T1605

+Limited Stock

Not All Items Stocked

Type A Rubber Base Paint

		ITEM NO.	
Dawn Blue	Type A	1 Gal. Pail	P1028+
Dawn Blue	Type A	5 Gal. Pail	P1528+

Type SBR Rubber-Base Paint

White	Type SBR	1-Gal. Pail	P8770
-------	----------	-------------	-------

Type DS (Dampset) Water-Base Paint

White	Dampset	1 Gal. Pail	P6011
White	Dampset	5 Gal. Pail	P6511
Dawn Blue	Dampset	1 Gal. Pail	P6028
Dawn Blue	Dampset	5 Gal. Pail	P6528
Black	Dampset	1 Gal. Pail	P6021
Royal Blue	Dampset	1 Gal. Pail	P6029

Type EP Epoxy Paint

White	Type EP	1 Gal. Pail	P3011
Dawn Blue	Type EP	1 Gal. Pail	P3028
Dawn Blue	Type EP	3 Gal. Pail	P3528
Royal Blue	Type EP	1 Gal. Pail	P3029
Black	Type EP	1 Gal. Pail	P3021

Type EP HI BUILD Epoxy Paint

<i>*1-Gallon Kit Makes 2 Gallons</i>		<i>*5-Gallon Kit Makes 10 Gallons</i>	
White	Hi Build	1 Gal. Kit*	P3311
Dawn Blue	Hi Build	1 Gal. Kit*	P3328

Type D-70 Vinyl Base Paint

White	D-70 Vinyl	1 Gal. Kit	P2011+
White	D-70 Vinyl	5 Gal. Kit	P2511+

SOLVENTS

Solvent for Type "A & EP"	1 Gal. Can	P8605
Solvent for Type "D-70" Paint	1 Gal. Can	P8610

NON-SKID ADDITIVE

Non-Skid Additive 1 Lb. Can	P8620
-----------------------------	-------

TYPE ADC DECK PAINT

Blush	#470	1 Gal. Pail	P8721+
Cape Cod	#462	1 Gal. Pail	P8720
Cayman Sand	#469	1 Gal. Pail	P8724
Dune Shadow	#463	1 Gal. Pail	P8723

+Limited Stock



AQUALUSTER: ACRYLIC PAINT

Self Priming Topcoat for Virtually All Types of Coatings and Damp Surfaces

Brilliant White	#3011	1 Gal. Pail	P6030
Black	#321	1 Gal. Pail	P6032
Dawn Blue	#328	1 Gal. Pail	P6033
Royal Blue	#329	1 Gal. Pail	P6034
Brilliant White	#3011	5 Gal. Pail	P6529
Dawn Blue	#328	5 Gal. Pail	P6530



CLEAN & PREP SOLUTION

Clean and Prep Solution is used to clean and degrease while simultaneously dissolving mineral deposits, increasing porosity for good adhesion on surfaces prior to painting.

Ramuc Clean & Prep Solution	P1517
-----------------------------	-------

CHLORINATED RUBBER TYPE A



A premium grade high-gloss rubber base pool paint/ Excellent for up-grading & restoring previously painted rubber surfaces.

Coverage 400 Sq. Ft.

AQUALUSTER



Topcoats and upgrades existing chlorinated and synthetic rubber systems, water based acrylic paints, and bare concrete or plaster.

Coverage 450 Sq. Ft. on recoats!

WATER-BASED TYPE DS



Dampset can be applied over most pool surfaces. Excellent for pools where downtime is critical. Can be applied to damp surface.

Coverage 350 Sq. Ft.

EPOXY TYPE EP



High gloss, low film build epoxy. Compatible with other epoxies, fiberglass, & bare plaster. Provides tile-like easy-to-clean film.

Coverage 450 Sq. Ft.

EPOXY TYPE EP HI BUILD



An epoxy paint designed to provide longest lasting finish of any pool paint. Compatible with other epoxies.

Coverage 125 Sq. Ft.

ACRYLIC DECK PAINT TYPE ADC



A deck product which upgrades "Kool Deck" & concrete surfaces. Will resist weather & pool chemicals.

Coverage 300 Sq. Ft.

ROLLER COVERS

ITEM NO.

- 4" Roller Cover & Frame R1025
- 9" Regular Roller Cover 3/4" Nap R1015
- 9" Regular Roller Cover 1/2" Nap R1016
- 9" Jumbo Roller Cover 3/4" Nap R1020
- 9" Jumbo Roller Cover 1/2" Nap R1022
- 18" Jumbo Roller Cover 3/4" Nap R1023

ROLLER FRAMES

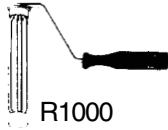

- 9" Regular Roller Frame R1000
- 9" Jumbo Roller Frame R1005
- 18" Regular Roller Frame R1002
- 18" Jumbo Roller Frame R1010
- Set of End Caps R1024

PAINT BRUSHES

- 2" Paint Brush R1075
- 4" Paint Brush R1080
- Masonry Brush R1083

SILVER DUCT TAPE

ITEM NO.

Silver Duct Tape
2" x 60 Yard Roll

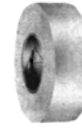

R1085
Case of 24

MASKING TAPE

Masking Tape
2" x 60 Yard Roll



R1090
Case of 24

ROLLER TRAYS

Plastic Roller Tray R1040
Metal Roller Tray R1045
Roller Tray for 18" Roller R1050*



BUCKET GRID

Bucket Grid R1070
for 5 Gallon Paint Pail



WOOD HANDLES

- 60" Threaded Wood Handle R1055
- 60" Threaded Wood Handle w/ Nylon Tip F5081
- 60" Threaded Wood Handle w/ Metal Tip R1060



*Non-Stock Item



SAU-SEA POOL PAINT

Sau-Sea Enamel Type R - Chlorinated Natural Rubber Base Pool Paint

SPECIAL BLOW OUT PRICES

- Tropic Blue #453 1-Gallon Pail P9053+
- Tropic Blue #453 5-Gallon Pail P9153+

+Limited Stock

SLIP RESISTANT EPOXY

- Clear Sure Traction Aerosol Epoxy - Slip Resistant - 12 Oz. R1186
- White Sure Traction Aerosol Epoxy - Slip Resistant - 12 Oz. R1188
- Black Sure Traction Aerosol Epoxy - Slip Resistant - 12 Oz. R1190

SPRAY PAINT Aerosol Cans



- | | | | |
|-------------------|-------|---|-------|
| White - Pint Can | R1100 | Traffic Yellow for Marking & Striping - 16 Oz. | R1148 |
| Black - Pint Can | R1110 | Red Fluorescent for Marking & Striping - 16 Oz. | R1150 |
| Gold - Pint Can | R1121 | White for Touching up Pool Coping - 12 Oz. | W6311 |
| Green - Pint Can | R1140 | Red - Pint Can | R1166 |
| Orange - Pint Can | R1142 | Yellow - Pint Can | R1143 |
| | | Blue Metallic - Pint Can | R1164 |
| | | Regal Blue - Pint Can | R1185 |
| | | Brown - Pint Can | R1180 |
| | | Beige - Tan - Pint Can | R1181 |

**WHITE POOL
PLASTER**

High Performance Pool Plaster 80 Lb. Bag
Cement & marble dust pre-mix 10 Bag Lots
Just add water. 42 Bag Lots

ITEM NO.
S4214



**MARBLE
DUST**

*Custom ground marble aggregate for hard smooth pool finish
 that does not require paint, resists staining & is easy to keep clean.*

Pool Mix 100 Lb. Bag T8000
*Simply mix with white portland cement
 & water to the right plasticity for plaster.* Skid of 30

U.S. Marble 50 Lb. Bag T8005
Skid of 60

POOL MIX

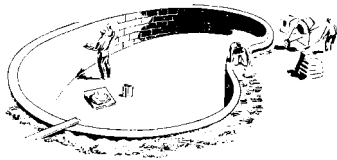

SGM- Diamond Brite Exposed Aggregate Pool Finish

Super Blue-	80 Lb. Bag	T8100
Cool Blue-	80 Lb. Bag	T8110
Blue- Quartz	80 Lb. Bag	T8120
Aqua- Quartz	80 Lb. Bag	T8122*
Midnight Blue-	80 Lb. Bag	T8130
Tahoe Blue-	80 Lb. Bag	T8132
Onyx-	80 Lb. Bag	T8138
French Gray-	80 Lb. Bag	T8140
Blue	80 Lb. Bag	T8145

Other Products Available Through Special Order

3M-COLORQUARTZ

Plum	S Grade-	50 Lb. Bag	T8080
Green	S Grade-	50 Lb. Bag	T8082
Black	S Grade-	50 Lb. Bag	T8084
Blue	S Grade-	50 Lb. Bag	T8086
White	S Grade-	50 Lb. Bag	T8088
Smoke	S Grade-	50 Lb. Bag	T8096
Buff	S Grade-	50 Lb. Bag	T8081
Taho Blue	T Grade-	50 Lb. Bag	T8085
Black	T Grade-	50 Lb. Bag	T8090
Blue	T Grade-	50 Lb. Bag	T8092
White	T Grade-	50 Lb. Bag	T8094

CEMENT MIX

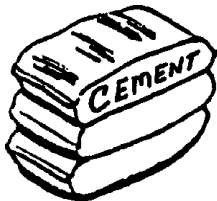

White Cement

94 Lb. Bag T8020

CUSTOM BLENDED PLASTER COLORS Highland Quartz Colors

Mix Ratio For Each Batch: 1 ZipLock Bag to 4 Bags of Cement.
Sold in 1 Batch ZipLock Bags. 16 or 30 Batches per Box. 18 Boxes Per Pallet

Highland QuartzColors - Quartz Blue	(30 Batches Per Box)	S4218
Highland QuartzColors - Medium Gray	(30 Batches Per Box)	S4219
Highland QuartzColors - Sand Stone	(30 Batches Per Box)	S4220
Highland Colors - Tahoe Blue	(16 Batches Per Box)	S4221
Highland Colors - Caribbean Blue	(30 Batches Per Box)	S4222
Highland Colors - Aqua	(30 Batches Per Box)	S4223
Highland Colors - Black	(16 Batches Per Box)	S4224

Highland Specialites, Inc.
Dose pack pool plaster colors

- Highest quality Automotive grade blues not watered down printers ink.
- Half -batch packaging
- Buy only what you need
- No more estimated measuring on the job site.
- No loss of preblends that sit unused.
- Dose packs = No Waste
- Consistent color in every batch on every job ?
PRICELESS.

www.Plastercolor.com (215)723-6172

Associate Member
NIPC
National Plasterers
COUNCIL

Thoro Lamp Black - Quart
Black Color Additive

ITEM NO.
 S4253

Multicoat Mulasticoat

Latex based elastomeric waterproofing membrane, can be used to seal and waterproof Ponds, Planters, Foundations, Rock Features, Roofs, etc.

Coverage for two coats is 40-50 Square Ft. per Gallon

- 1 Gallon Pail T8034
- 5 Gallon Pail T8033



MULTICOAT Scratch Kote 65 Lb Bag T8030
 Coverage: 180 - 200 Sq. Ft. *Skid of 40*
Used to prep pool wall before plastering. Forms hard, rough textured base coat for solid white coat bond.

SGM Bond Kote
Used to prep pool walls prior to plastering

SGM - Bond Kote Liquid Resin 5 Gallon T8141
Use One 5 Gal. Pl. For 2 Bags Of Powder

SGM - Bond Kote Powder 85 Lb. Bag T8143
**Use Two Bags of Powder per 5 Gal. T8141 Liquid Resin -*

MetaMax PA Plaster Additive 55 Lb. Bag T8032
High quality pozzolanic additive for plaster

Helps produce plaster w/ a creamy texture, improving trowelability, making it easier to apply & finish

TILE & PLASTER REPAIR



Tile Grout & Plaster Repair 5 Lb. Pail S4215
Waterproof, fast setting white cement compound for repairing tile & plaster

CONCRETE REPAIR



Concrete Repair 5 Lb. Pail S4217
Fast setting cement compound for all masonry repairs



THORO SYSTEM PRODUCTS



Acryl 60

Liquid bonding agent
Improves adhesion
& mechanical properties of
cement

PACKING	ITEM NO.
4 Gal./Case	S4227
5 Gal. Pail	S4235



Thorseal

Waterproofs, seals
& protects concrete
finish.

White	50 Lb. Bag	S4233*
Gray	50 Lb. Bag	S4232*



EMACO GP

Same as Thorite

Patches vertical crack &
spalled concrete. Molds to Shape

4 x 12 Lb./Case	S4252+
60 Lb. Pail	S4250

EMACO GRIP

Same as Thorogrip

Anchoring cement
for setting posts & bolts

50 Lb. Pail	S4245
-------------	-------



Waterplug

Seals wall-to-floor joints
Stops running water instantly

4 x 10 Lb./Case	S4240
50 Lb. Pail	S4242

CGM CONCRETE PRODUCTS

Anchor-Tite

For posts & bolts

PACKING	ITEM NO.
6 x 5 Lb./Case	S4046
4 x 10 Lb./Case	S4045
50 Lb. Pail	S4047

Perma-Cement

Rapid setting, durable
cement. Just add water

12 x 3 Lb./Case	S4025
4 x 10 Lb./Case	S4030
50 Lb. Pail	S4035



Perma-Weld

Bonds new concrete to old

4 Gal./Case	S4050
-------------	-------



Pool Patch

White patching cement

12 x 3 Lb./Case	S4264+
4 x 10 Lb./Case	S4266

Tile Grout

Will cover 12 Sq. Ft. per Lb.

12 x 1 Lb./Case	S4058
6 x 5 Lb./Case	S4060



Wet Plug

Hydraulic cement plugs leaks

12 x 3 Lb./Case	S4040
4 x 10 Lb./Case	S4042
50 Lb. Pail	S4044

+LIMITED STOCK
*NON-STOCK SPECIAL ORDER ONLY



DECK-O-SEAL - Chlorine Resistant

Pourable Grade (Poly Sulfide)

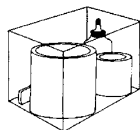

					ITEM NO.
96 Oz. Kit	Deck-O-Seal	White	4 Kits/Cs.		S1220
	<i>Pour Grade</i>				
96 Oz. Kit	Deck-O-Seal	Grey	4 Kits/Cs.		S1221
	<i>Pour Grade</i>				
96 Oz. Kit	Deck-O-Seal	Tan	4 Kits/Cs.		S1222
	<i>Pour Grade</i>				

		WIDTH OF JOINT							
		1/4"	3/8"	1/2"	5/8"	3/4"	7/8"	1"	
DEPTH OF JOINT	1/4"	231	154	106	92	77	66	58	
	3/8"		102	77	62	51	44	38	
	1/2"			58	46	38	33	29	
	5/8"				37	31	26	23	
	3/4"					26	22	19	
7/8"						19	17		
1"							14		

Gun Grade

96 Oz. Kit	Deck-O-Seal	White	4 Kits/Cs.	S1230
	<i>Gun Grade</i>			
96 Oz. Kit	Deck-O-Seal	Grey	4 Kits/Cs.	S1231
	<i>Gun Grade</i>			
96 Oz. Kit	Deck-O-Seal	Tan	4 Kits/Cs.	S1232
	<i>Gun Grade</i>			



BOSS SILICONE ADHESIVE & SEALANT

Silicone Adhesive #801 - Neutral Cure	10.3 Oz. Tube	Clear	12/Cs.	S1106
		White	12/Cs.	S1107
<i>One-part, low odor, non-corrosive, oxime cure adhesive & sealant. Provides excellent adhesion to ceramic tile, spa jets, skimmers, lighting fixtures, plumbing & fiber optic lighting</i>				
Ceramic Tile Grout #804	10.3 Oz. Tube	White	12/Cs.	S1108
Scrubber for cleaning off excess grout				V7290
Sponges				V7292

NOVAGARD RTV SILICONES

Tile Adhesive "Fast Tack" RTV 700	10.3 oz. Tube	White	24/Cs.	S1068
<i>Adhesive to masonry, rovel, acrylic, fiberglass, ABS, PVC, wood & ceramic</i>				
Tile Grout "Slow Tack" RTV 700	10.3 oz. Tube	White	24/Cs.	S1069
<i>A slow tack, E-Z Odor, grout, adhesive & sealant</i>				
General Purpose Silicone RTV 700	10.3 oz. Tube	Clear	24/Cs.	O1266
<i>For sealing jets, skimmers, light fixtures, fiber optic lighting & plumbing</i>				



SILICONE SEALANT

Silicone Sealant	10.3 Oz. Cartridge	Clear	12/Cs.	S1011
		White	12/Cs.	S1013
Silicone Sealant	3 Oz. Tube	Clear	12/Cs.	S1009

VULKEM SEALANTS

For swimming pool decks. Extraordinary adhesion, cohesion, abrasion & tear resistance. Vulkem 45 is suitable for continuous water immersion. One-Part Polyurethane Sealant.

DEPTH OF JOINT	WIDTH OF JOINT						
	1/4"	3/8"	1/2"	5/8"	3/4"	7/8"	1"
1/4"	1	2	2	3	3	4	4
3/8"	2	2	3	4	5	5	6
1/2"	2	3	4	5	6	7	8

APPROXIMATE NUMBER OF CARTRIDGES PER 25 FEET OF JOINT

Vulkem #45 Quart Tube <i>Self-Leveling</i>	White	12/Cs.	S1005
	Gray	12/Cs.	S1006
	Tan	12/Cs.	S1027

ITEM NO.

Vulkem #116 is a one-part moisture curing, gun grade polyurethane sealant. Offers durable, flexible performance in moving joints. Is suitable for continuous water immersion. High performance elastomer.



Vulkem #116 11 Oz. Cartridge <i>Gun Grade</i>	White	30/Cs.	S1007
	Gray	30/Cs.	S1008
	Tan	30/Cs.	S1028
	Limestone	30/Cs.	S1010

One-part, low modulus, gun-grade sealant offering. Excellent performance in moving joints, smooth finish.

Dynamic #921 Sealant (Same as Vulkem)	10 oz. Tube	Gray	30/Cs.	S1032
	10 oz. Tube	Dark Tan	30/Cs.	S1029

Convenient foil wrapped sausage tube - Requires special caulking gun

Dynamic #921 Sealant (Same as Vulkem)	20 Oz. Sausage "Chub"	White	15/Cs.	S1002
	20 Oz. Sausage "Chub"	Gray	15/Cs.	S1003
	20 Oz. Sausage "Chub"	Dark Tan	15/Cs.	S1000

SONNEBORN SEALANTS



Moisture-curing high performance polyurethane sealant. For use on concrete & expansion wall joints. Bonds without primer. Excellent flexibility.

Sonneborn NP-1	20 Oz. "Chub"	Alum Gray	20/Cs.	S3000
		Tan	20/Cs.	S3001
		White	20/Cs.	S3002
		Limestone	20/Cs.	S3003
		Stone	20/Cs.	S3004
Sonneborn NP-1	10.3 Oz. Tube	Alum Gray	30/Cs.	S3010
		Tan	30/Cs.	S3011
		White	30/Cs.	S3012
		Limestone	30/Cs.	S3013

3M POOLSIDE CONCRETE REPAIR KITS

A quick-setting, non-sag or self-leveling urethane used to repair concrete cracks and holes. Also used to anchor bolts and handrails. More durable than epoxy. Cures in 5 minutes.

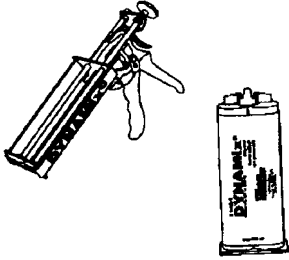

		ITEM NO.
Pool & Patch Repair Kit (Self-Leveling)	12 Oz.	S4412
3M #600 Concrete Repair Non-Say Urethane - Gray		S4400
<i>Used for crack repair, expansion joints, and anchoring</i>		
Self-Leveling 2-Part Urethane - Gray		S4402
Manual Dispenser for 12 Oz. Cartridge		S4430
Blunt End Mixtip for 12 Oz. Cartridge	(12 Pack)	S4420
Polyethylene Spreader 6" x 8" x 1/8"		S4428

POOLFIX - Crack Repair & Leak Stoppage

Instant Noxy-Bond system works on most types of pool equipment including vinyl liners & inflatables

POOLFIX Adhesive & Filler System	- Retail Size 10g	S4500
(Dry Application Only)	- Industrial Size 20g	S4510

PLAST-AID - Multipurpose Premium Adhesive

Forms hard durable waterproof plastic in 15 minutes. Used to repair breaks, fill gaps & custom shapes

Plast-Aid Multi-purpose Repair Plastic .75 oz.	S4520
---	-------

CAULKING GUNS

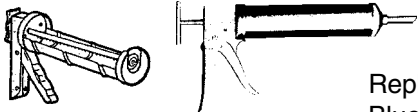

Small Caulking Gun for 11 Oz. Cartridge	S1023
Large Caulking Gun for Quart Cartridge	S1024
Sausage Caulking Gun for 20 Oz. Chub	S1061
Nylon Front Cap for Sausage Gun	S1066
Replacement Plastic Tip for Sausage Caulking Gun	S1067
Blue Pusher Disc for Sausage Caulking Gun	

BACKER ROD

Sealant

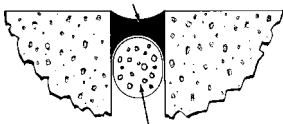

Backer Rod

5/8" Round Foam	1550 Ft. Roll	S1033
	.5 Roll	775 Ft. Roll
		S1033
		- Cut to Size
		S1020
3/4" Round Foam	1100 Ft. Roll	S1036
		- Cut to Size
		S1030
1" Round Foam	600 Ft. Roll	S1045
		- Cut to Size
		S1040
7/8" Sof Rod Foam	850 Ft. Roll	S1039
		- Cut to Size
		S1038
1-1/8" Sof Rod Foam	500 Ft. Roll	S1042
		- Cut to Size
		S1041

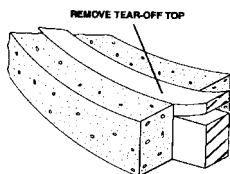

FOAM EXPANSION JOINT

3/8" x 3" Wide Foam	50 Ft. Roll	S1050
3/8" x 4" Wide Foam	50 Ft. Roll	S1055
3/8" x 3" Wide Foam w/ 1/2" Removable Strip	50 Ft. Roll	S1058
3/8" x 4" Wide Foam w/ 1/2" Removable Strip	50 Ft. Roll	S1060

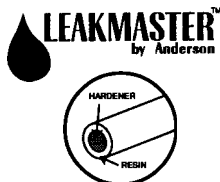

POOL PUTTY & PASTE

			ITEM NO.
Epoxy Bond 2-Part Pool Putty	White	5/Box	S4021
Epoxy Bond 2-Part Pool Putty	Black	5/Box	S4026
Epoxy Bond Pool Paste - Fast Set	3/4 Oz.	12/Box	S4023
Epoxy Bond Pool Paste	16 Oz.		S4024
A & B Epoxy Putty 2 Part	16 Oz. White		S4000
A & B Epoxy Putty 2 Part	16 Oz. Black		S4001
A & B Epoxy Putty Fast Set	8 Oz.		S4006
A + B Epoxy Paste - Fast Set	5 Oz. Box	10/Box	S4020+
LeakMaster Pool Repair Putty - Regular Tube		Each	S4016
LeakMaster Pool Repair Putty - Quick Set		Each	S4014
Permatex Pool Epoxy Stick	4 Oz. Tube	Each	S4072

+Limited Stock

PRESSURE PATCH

Excellent for damp, moist & even underwater applications. Twice the strength of concrete.



Standard Kit	11.25 Oz.	12/Case	S4294
<i>One Kit does: 6 Lin. Ft. (1/8" Wide x 1" Deep)</i>			
<i>3 Lin. Ft. (1/4" Wide x 1" Deep)</i>			
Mid Size Kit		6/Case	S4292
<i>Four times the size of a standard kit</i>			
Gallon Size Kit		4/Case	S4290
<i>Eight times the size of a standard kit</i>			

PRESSURE SEAL

Pressure Seal		12/Case	S4296
<i>Stops leaks immediately. Seals through water.</i>			
<i>Remains sealed in expansion areas. - Stretches up to 350%</i>			

LEAKMASTER RUBBER SEALER

Permanent all-purpose sealant. Can be applied underwater



Flexible Rubber Sealer - Blue	4 Oz. Tube	24/Case	S4010
Flexible Rubber Sealer - White	4 Oz. Tube	24/Case	S4012
Stop AQ Inert Visco-Elastic Sealing Compound	.31 Liter Tube	24/Case	S1014

SCHMEAR

"Schmear" Compound for Field Repair (Requires MEK) - White	V1009
- Black	V1010

VINYL PATCH KITS



"Wet" Vinyl Patch Kit	2 Oz. Box	24/Box	S1080
Vinyl Adhesive for "Wet" Patch Kit	4 Oz. Can	12/Box	S1090
Vinyl Adhesive for "Wet" Patch Kit	Pint Can	6/Box	S1095
Combo "Wet/Dry" Patch Kit		12/Box	S1082+
Quick Patch Pool Patch		24/Box	S1100
Easy Patch		24/Box	S1075

+Limited Stock

REPAIR ANYTHING PRODUCT

Mr. Sticky Epoxy Glue

This product is truly amazing and it really works. Regardless of who you are (builder, retailer, mechanic, homeowner, etc.) you should have a tube of this for any type of repair on any type of surface - underwater, wet, dry or cold. Extremely flexible bonds to material by molecular interaction - most glues bond mechanically (on the surface).

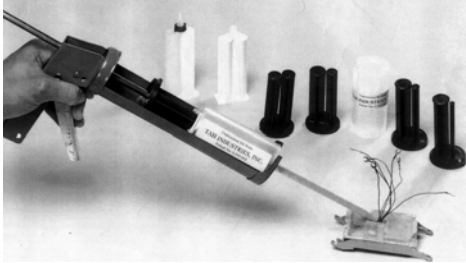

- 30 Gram Syringe - White S4305
- 50 ml Syringe - White S4310
- Caulking Gun Adapter S4316
- Special Dispensing Gun S4318
- 1/16 -1/8 Mixing Tip for Special Dispenser S4312
- 3/16 Mixing Tip for Special Dispenser S4314

Do it Wet !

Compare!	Properties
Flexible, Shock Absorbing Bond 	Flexibility (stretch%) Shock Dampening Flexible Bonds Flexibility is required for bonds to withstand thermal or mechanical shocks.
Underwater Bonding 	Tackiness Underwater Curing Underwater Adhering Underwater PVC Pipe Fittings Mr. Sticky's® cures and sticks underwater.
PVC Bonding 	Shear (PVC bond) 180° Peel (PVC bond) PVC bond Forget threading. Mr. Sticky's® even glues PVC fittings to metal pipe !



Repair Sportsman's items In The Field such as: Waders, Campers, Decoys, Tackle, Bows, Rifles & Boats!

Mr. Sticky's® will

Mr. Sticky's® is a registered trademark of MSI, Fair Oaks, California

Do it Cold !

Mr. Sticky's® Underwater Glue	Typical Epoxy Glue, Paste or Putty
Excellent (30%) Excellent Excellent	Poor/Brittle (1-4%) Poor/Brittle Poor/Brittle
Mr. Sticky's® resists bending, shock and vibration failures because it is a flexible bond, not brittle like typical epoxies. It is even recommended to fix inflatable boats and toys!	
Very Tacky Yes Yes Tested to 1400 psi	Limited to None Varies Limited/Mechanical Bond
Mr. Sticky's® molecular interaction force displaces water then bonds to material. Some epoxies cure underwater, but most only bond mechanically by surrounding object and then hardening.	
1800 psi - Strong 40 lbs./in Very Good	Limited - Weak Poor (< 5 lb.) Limited
Mr. Sticky's® bonds PVC to a wide variety of materials. (PVC cement is a solvent and melts PVC together.)	

Direct-Bond PVC Fittings to Copper, Galvanized, Black or Old-Rusty Pipe!
Forget Threading Pipe Forever!

For more information visit:
www.underwaterglue.com

Results of independent testing:

Results for 1/2" PVC couplings glued, cured for 24 hours and quick burst tested per ASTM standard D 1599-88 for short term hydraulic failure were in excess of 1900 psi. Although the body of the fitting shattered at these pressures, it should be noted that there appeared to be no seperation of the glued joint. Similar results were achieved in tests glued and cured entirely underwater. 1-1/4" fittings were routinely tested in excess of 1400 psi again with no seperation of the glued joint.

Glue and Hold !

Magic Lube

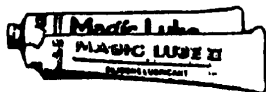

H8058



S4027



V7065



H8059



S4092

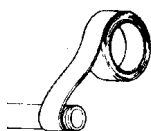

V1205



S4070



S4091



S4080

LUBRICANTS

Magic Lube - A teflon based, multipurpose sealant/lubricant used on motors, o-rings, gaskets, bearings, water filters & more.

Magic Lube -	Teflon Base	1 Oz. Tube	H8055
Magic Lube -	Teflon Base	5 Oz. Tube	H8057

Magic Lube II - A silicone based lubricant for use under most adverse conditions. Ideal for valves & other special applications.

Magic Lube II -	Silicone Base	1 Oz. Tube	H8051
Magic Lube II -	Silicone Base	5 Oz. Tube	H8053

Aqua-Lube 8 Oz. Tube H8058

Jack's Lube 1 Oz. Tube S4125

SBG Aerosol Lube -Silicone 4 Oz. Can S4027

LubriChem Lubricant 1-1/2 Oz. Tube S4028

Super Lube 3 Oz. Tube H8061

Super Lube 400 Gm. Can H8059

Water Lube 1.75 Oz. Tube H8056

WD-40 11 Oz. Can V7065

*Non-Stock Item

PERMATEX PRODUCTS

No More Leak - White 1 Pint S4075+

Form-A-Gasket #2 11 Oz. Tube S4080

Form-A-Gasket #3D 1 Pint S4085

Form-A-Gasket #6M 12 Oz. Tube S4090+

Form-A-Gasket Superflex RTV 300 ML S4091

Ultra Blue Silicone Sealant 3.35 Oz. S4073

Ultra Copper High Temp Silicone 3 Oz. S4076

High Tack Super Adhesive #99MA S4095

Lock Nut 1/6 Oz. Vial S4105+

Teflon Thread Sealant 4 Oz. Can S4109

Pipe Joint Compound 51D 1 Pint S4092

+Limited Stock

SPRAY ADHESIVES

Sticky Spray 4 Oz. Can S4029

Holds O-rings & gaskets in place

Bostik Pooltak 17 Oz. Can S4097

Pool Wall Spray Adhesives

SEALANTS

Teflon Tape - Large Roll 1/2" x 520" V1205

Hercules "Grrrip" 1/2 Pint S4087

All Purpose Threaded/Gasket Sealant

RECTOR SEAL SEALANTS

Rector Seal #5 Thread Sealant 1 Pint V1054

Rector Seal #5 Thread Sealant 1 Quart V1056

Rector Seal T 2 Plus 1 Pint V1050

Rector Seal T 2 Plus 1 Quart V1052



QUAKER PLASTIC PRODUCTS

AN EMPLOYEE OWNED COMPANY

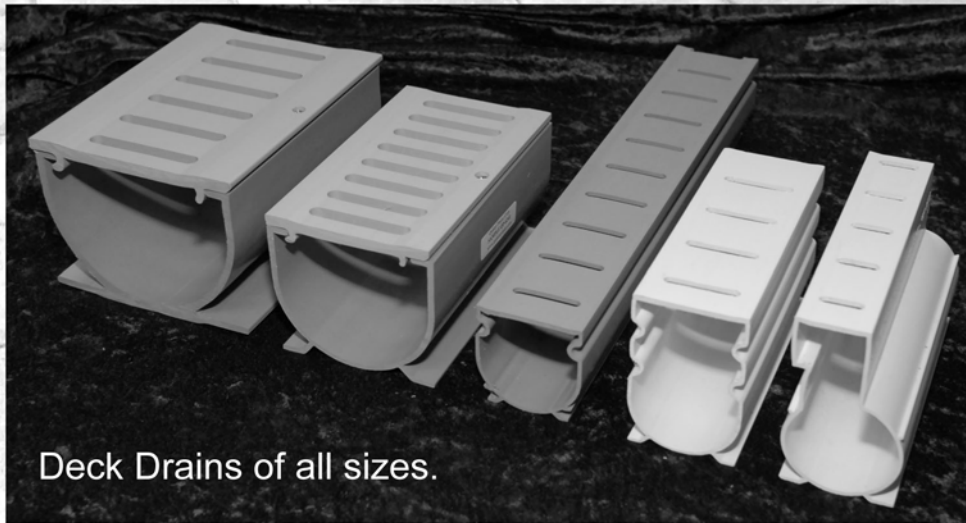

Deck Drains of all sizes.

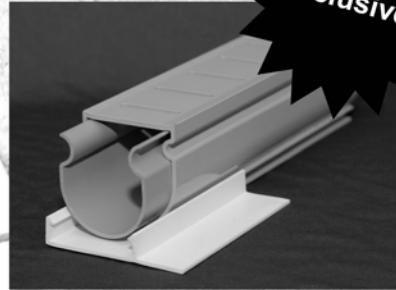
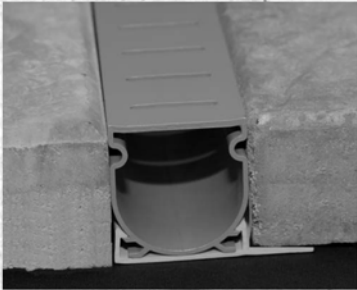

Exclusive!

2" Paver drain, made specifically for pavers. Ready to install.

Deck Drains of all sizes

Fittings of all sizes

Control Joints

Coping Forms

Discharge Hose

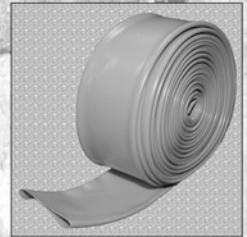

If It's Quaker - It's Made in America
Quality Products for Over 30 Years
www.quakerplastic.com



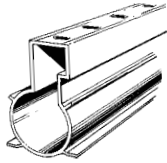

QUAKER 1-1/2" DECK DRAIN SYSTEM

Quaker Deck Drain - White	1-1/2" x 8'	(9 per Case)	ITEM NO. T1560
Quaker Deck Drain - Tan	1-1/2" x 8'	(9 per Case)	T1561
Quaker Deck Drain - Gray	1-1/2" x 8'	(9 per Case)	T1564
Quaker Deck Drain - Black	1-1/2" x 8'	(9 per Case)	T1562+

Fittings for Quaker Deck Drain:

90 Degree Inside Elbow for Quaker Deck Drain	<p>90° Outside</p>
90 Degree Outside Elbow for Quaker Deck Drain	
45 Degree Inside Elbow for Quaker Deck Drain	
45 Degree Outside Elbow for Quaker Deck Drain	



90° Inside



Clean-Out Plug

Quaker Universal Tee	<p>Tee</p>
Quaker Universal Cross	

Bottom Drain Out for Deck Drain	T1730
Top End Cap for Deck Drain	T1739
Nipple for Deck Drain	T1741

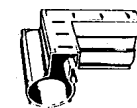

90° Outside



Tee

	Tan	Gray	White
T1713	T1712	T1710	
T1718	T1717	T1715	
T1703	T1702	T1700	
T1708	T1707	T1705	
T1723	T1721	T1720	
T1728	T1726	T1725	

QUAKER 2" SQUARE DRAIN SYSTEM

Adaptable to standard 1-1/2" fittings - Greater water volume - Easy upright installation

Quaker Square Drain System - White	2" x 10'	(8 per Case)	T1570
Quaker Square Drain System - Tan	2" x 10'	(8 per Case)	T1571
Quaker Square Drain System - Gray	2" x 10'	(8 per Case)	T1572
45 Degree Elbow for 2" Quaker Square Drain - White			T2000
45 Degree Elbow for 2" Quaker Square Drain - Tan			T2001
45 Degree Elbow for 2" Quaker Square Drain - Gray			T2002
90 Degree Elbow for 2" Quaker Square Drain - White			T2005
90 Degree Elbow for 2" Quaker Square Drain - Tan			T2006
90 Degree Elbow for 2" Quaker Square Drain - Gray			T2007
Side Adapter for 2" Quaker Square Drain - White			T2010+
Side Adapter for 2" Quaker Square Drain - Tan			T2011+
Side Adapter for 2" Quaker Square Drain - Gray			T2012+
Bottom Drain Out for 2" Quaker Square Drain - White			T2015+
Bottom Drain Out for 2" Quaker Square Drain - Tan			T2016+
Bottom Drain Out for 2" Quaker Square Drain - Gray			T2017+
Tee for 2" Quaker Square Drain - White			T2020+
Tee for 2" Quaker Square Drain - Tan			T2021+
Tee for 2" Quaker Square Drain - Gray			T2022+
Cross for 2" Quaker Square Drain - White			T2025+
End Cap for 2" Quaker Square Drain - 3-1/8"			T2030+
End Cap for 2" Quaker Square Drain - 1"			T2032+

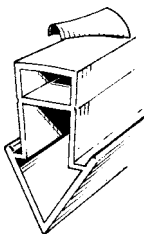

+Limited Stock

QUAKER EXPANSION JOINT

Quaker Expansion Joint - White	5/8" x 12' Taped	(20 per Case)	T1582
Quaker Expansion Joint - Tan	5/8" x 12' Taped	(20 per Case)	T1581
Quaker Expansion Joint - Gray	5/8" x 12' Taped	(20 per Case)	T1590

Fittings for Expansion Joint:

	Tan	Gray	White
45 Degree -	T1753	T1752	T1750
90 Degree -	T1758	T1757	T1755
Tee -	T1763		T1760
4" Connector Pin -			T1780

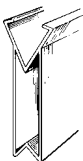

QUAKER EXPANSION BASE

Quaker Expansion Base - White	5/8" x 12'	(16 per Case)	T1592
--------------------------------------	------------	---------------	-------

+Limited Stock

MORTEX CONTROL JOINT

Mortex Control Joint	5/8" x 12' - White	ITEM NO. T1584
Mortex Control Joint	5/8" x 12' - Tan	T1586

REPLACEMENT CAP FOR DECK DRAIN

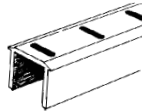

Quaker 4' Replacement Cap for Competitor's Deck Drain

White	Each	T1580
	(24 per Case)	
Tan	Each	T1587
	(24 per Case)	

*For repair of commonly used drain systems.
Simply saw out damaged area and insert new top*

REPLACEMENT CAP FOR CONTROL JOINT



Replacement Cap for Competitor's Control Joint - 12' Piece
Renu-Strip Cap for Control Joint (Deck-O-Seal) - 10' Piece

*Simply saw cut length of joint to be repaired.
Silicone the top & press on replacement cap*

White	Each	T1585
White	Each	S1224

Fits all 5/8" Wide Expansion Joint

NDS SPEE-D CHANNEL 4" WIDE DRAIN

NDS Spee-D Channel Drain - 10' Section		T1900
NDS Spee-D Channel Drain - 4' Section (<i>UPS'able</i>)		T1901
NDS Channel Grate - 2' Pc. Color: Gray		T1902
NDS Channel Grate - 2' Pc. Color: Sand		T1904
NDS Channel Grate - 2' Pc. Color: Black		T1906
NDS Channel Grate - 2' Pc. Color: White		T1903
NDS Channel Grate - 2' Pc. Color: Red Brick		T1905
NDS Channel Grate - 2' Pc. Color: Green		T1907
Screws Only for Channel Grate, S.S. Type "A" F.H. #8 x 1"		T1909
NDS Channel Coupling - Gray Only	T1926	
NDS End Cap - Gray Only	T1924	
NDS End Outlet - 2" Schd 40 Spigot Adapter - Gray Only	T1908	
NDS Bottom Outlet with Strainer for 3" or 4" Drain Fitting	T1910	
NDS 6" Installation Stake	T1911	

Fabricated Fittings for Channel Drain

	NDS Fabricated Tee & Grate - 7" Long Color: Gray	T1912
	NDS Fabricated Tee & Grate - 7" Long Color: Sand	T1914
	NDS Fabricated Tee & Grate - 7" Long Color: Black	T1916
	NDS Fabricated 90 Degree Elbow & Grate - 7" Long Color: Gray	T1918
	NDS Fabricated 90 Degree Elbow & Grate - 7" Long Color: Sand	T1920
	NDS Fabricated 90 Degree Elbow & Grate - 7" Long Color: Black	T1922
	NDS Fabricated 45 Degree Elbow & Grate Color: Gray	T1928
	NDS Fabricated 45 Degree Elbow & Grate Color: Sand	T1930

ROUND DECK DRAINS & ADAPTERS

3" Round Drain Grate	N1139
4" Round Drain Grate	N1138
3" Coupling DWV x PVC	
4" Coupling DWV x PVC	N1136



NDS DECK DRAIN & CONTROL JOINT

Mini Channel Drain 6' Pc.	Gray	T1970
Mini Channel Grate 3' Pc.	Gray	T1974
Mini Channel Grate 3' Pc.	Black	T1978
Mini Channel Grate 3' Pc.	Sand	T1980
Mini Channel 2" Sch. 40 Spigot End Outlet	Gray	T1984
Mini Channel 3" End Cap	Gray	T1987
Mini Channel Drain 3" Coupling	Gray	T1988
Mini Channel 3" 90 Degree Elbow	White	T1993
Mini Channel 3" 90 Degree Elbow	Sand	T1990
Mini Channel 3" Tee	Sand	T1992
#529 S.S. Screw for Mini Channel Drain		T1994
3' Channel w/ 2" Sch. 40 Bottom Outlet for Mini Drain		T1996

STEGMEIER CANTILEVER DECK FORMS

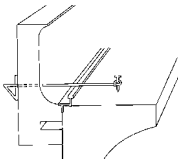

REGULAR FORM FOR GUNITE POOLS

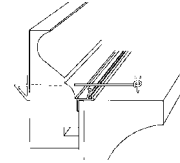

COMMERCIAL FORM FOR PUBLIC POOLS

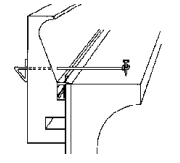

CAPSTONE FORM FOR FIBER-OPTIC

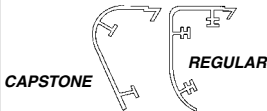

		ITEM NO.
Deck Forms - (Capstone) for Gunite Pool with Tile Strip & Tie Wire	(14 - 8'/Case)	T1548
Deck Forms - (Regular) for Gunite Pool with Tile Strip & Tie Wire	(14 - 8'/Case)	T1550*
Deck Forms - for Automatic Pool Covers 1-3/4" Ext. Strips	(13 - 8'/Case)	T1598
Deck Forms - (Fiber Optic) Perimeter Lighting Complete w/ Receiver - Gunite	(14 - 8'/Case)	T1510
Deck Forms - (Regular) for Vinyl Liner Pools Clip Loc	(14 - 8'/Case)	T1549

Preformed Corners

Preformed Corners for Deck Forms
(Available in Regular or Capstone)



12" Radius Inside	(4/case)	T1501*
6" Radius Inside	(4/case)	T1502+
6" Radius Outside	(4/case)	T1503+

Nose Caps

*Non-Stock Item
+Limited Stock

Nose Caps for Regular Deck Forms (Quaker) - White	(100/Case)	T1770
Nose Caps for Regular Deck Forms (Stegmeire) - White	(100/Case)	T1544
Nose Caps for Capstone Deck Forms (Stegmeire) - Tan	(100/Case)	T1545
Nose Caps for Capstone Deck Forms (Stegmeire) - White	(100/Case)	T1546
Nose Caps for Regular Deck Forms (Quaker) - White	(100/Case)	T1771
Nose Caps for Regular Deck Forms (Quaker) - Gray	(100/Case)	T1772
Nose Caps for Capstone Forms (Quaker) - Tan	(100/Case)	T1774
Nose Caps for Capstone Forms (Quaker) - Gray	(100/Case)	T1776
Nose Caps for Capstone Forms (Quaker) - White	(100/Case)	T1775
Nose Caps for Capstone Forms (Quaker) - Tan	(100/Case)	T1793

SLIP-N-JOIN LUMBER

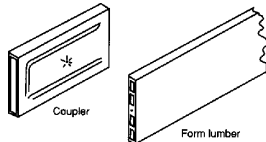

Slip-N-Join Lumber w/Couplings for Outside Concrete Deck Forming	(12 - 12'/case)	T1518
Slip-N-Join Couplers	(12/case)	T1519

EQUIPOTENTIAL BONDING GRID SYSTEM

See Following Page for Details

2' x 100' roll and accessory kit	T1640
3' x 100' roll and accessory kit	T1645

FRONTIER DECK DRAIN

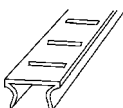
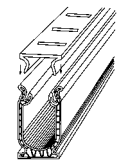

Frontier Deck Drain w/ Removable Top - White	(80'/Case)	T1516
Frontier Deck Drain w/ Removable Top - Tan	(80'/Case)	T1523
Frontier Deck Drain w/ Removable Top - Grey	(80'/Case)	T1521
Top Cap Only for Frontier Deck Drain - White		T1504
Top Cap Only for Frontier Deck Drain - Tan		T1505
Top Cap Only for Frontier Deck Drain - Grey		T1506
90 Degree Fitting - White		T1800
90 Degree Fitting (Stegmeier) - Grey		T1801
90 Degree Fitting - Tan		T1802
Side Adapter (Stegmeier)		T1870
End Adapter (Stegmeier)		T1872

Equipotential Bonding Grid System



Bonding Grid Meets NECE 680.26 (C)

NEC 680.26 (C) requires that all parts specified in 680.26(B) shall be covered or bare, not smaller than 8 AWG or rigid metal conduit of brass or other identified corrosion-resistant metal conduit. Connection shall be made by exothermic welding or by listed pressure connectors suitable for the purpose and are of stainless steel, brass, copper, or copper alloy.

Used underneath the paved surface 3' out from the edge of the pool

EquiBond Grid comes in two sizes: 2'x 100' roll (T1650), and 3'x100' roll (T1645). All made from welded #8 solid copper, with 12" spacing on grid. Each roll comes with the accessory kit above, and can be installed by one person. When using a 12" beam on pool edge, the 2' wide roll provides a total of 3' from edge of pool. When less than a 12" beam is used, the 3' wide roll is required.

	ItemNo.
2' x 100' Roll and Accessory Kit	T1640
3' x 100' Roll and Accessory Kit	T1645

Accessories Include



JRD Rebar Clamps ItemNo. T1610
 (Each clamp is UL listed for 2 #8 Bond wires works on 3/8" to 1" rebar)













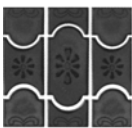
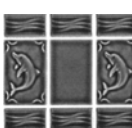

Bonding wire connector T1612

Bare #8 Bonding Wire 500' roll T1614

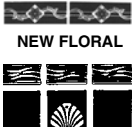
#8 Green Coated 500' wire for bonding light niches T1616

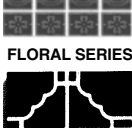
SHEET TILE - FROST FREE

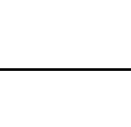
for Pools & Spas

	PRODUCT	DESCRIPTION	COLOR	SHEETS	LINEAR FT.	SQ. FT.	ITEM NO.
	AG-60	Angel Fish	Blueberry	25	57.50	28.75	T4069
	AK-135	Akron Series	Cobalt Blue	20	43	21.60	T4061+
	AS-13	Aquatic Series	Royal Blue	24	55	27.60	T4029+
	AS-14	Aquatic Series	Teal Blue	24	55	27.60	T4027+
	DPQ-10	Aqua Series	Cobalt Blue				T4088
	BUE-240	Botanical Series	Cobalt Blue	20	40	21.40	T4605
	BUE-22	Botanical Series	Marble Royal Blue	20	40	21.40	T4601
	BUE-44	Botanical Series	Lake Blue	20	40	21.40	T4603
	BUE-40	Botanical Series	Caribbean Blue	20	40	21.40	T4606
	BUE-37	Botanical Series	Teal Green	20	40	21.40	T4610
	DA-190	Diamond Series	Blueberry	20	43	21.60	T4660
	DA-30	Diamond Series	Cobalt	20	43	21.60	T4714
	DA-378SK	Diamond Stone	Ocean w/Soap	20	43	21.60	T4662
	DP-30	Dolphin Series	Cobalt Blue	25	58	28.75	T4001
	DP-60	Dolphin Series	Blueberry	25	58	28.75	T4038
	L-435	Listello Series	Pacific Blue				T4609
	DPQ-30	Aqua Series	Terra Blue	20	43	21.60	T4089
	FG-13	Tulip Series	Navy Blue	24	55	27.60	T4712+
	FRC-11R	Petal Series	Pink/Blue	20	40	28.75	T4084+
	M-5841	Small Moonglow	Royal Blue	30	60	30.00	T4320
	NF-4	New Floral	Navy Blue	24	55	27.60	T4350+
	NF-6	New Floral	Teal Green	24	55	27.60	T4352
	SL-30	Shell Series	Cobalt Blue	25	58	28.75	T4057
	SL-60	Shell Series	Blueberry	25	58	28.75	T4070
	SL-11	Starlight Series	Teal	24	55	27.60	T4700
	SQP-170	Floral Series	Teal	25	58	28.75	T4003+
	STB-807	Sunburst	Terra Blue	20	40	19.60	T4020
	STB-808	Sunburst	Cobalt Blue	20	40	19.60	T4025
	STB-812	Sunburst	Teal	20	40	19.60	T4015
	STB-819	Sunburst	Blue Gray	20	40	19.60	T4019
	SKN-10	Rosetta		20	40	21	T4080
	RM-103	Random		20	40	21	T4081
	RM-102	Random		20	40	21	T4082
	WS-252	Waterside Series	Lake Blue	20	40	21	T4607
	WS-105	Waterside Series	Royal Blue	20	40	21	T4608
	WS-2440S	Waterside Series	Terra Blue	20	40	21	T4713
	ZC-141	Zodiac	Royal Blue	30	63	31.50	T4039
	ZC-166	Zodiac	Terra Blue	30	63	31.50	T4330
	WA-44K	Wave Series	Pacific Blue	20	43.20	21.60	T4063

6" X 6" TILE - FROST PROOF

Ask for Special Prices on Skid Quantities on all 6 x 6 Tiles



6" x 6" Solid Accent Colors

				SOLID COLOR			
	PRODUCT DESCRIPTION	COLOR	PIECES	LINEAR FT.	SQ. FT.	ITEM NO.	
000079	Turchese Chiaro 6" x 6"	Light Blue	46	23	11.5	T4060	
000084	Turchese - Bullnose	Light Blue			Each	T4065	
000081	Blu Marino 6" x 6"	Green	46	23	11.5	T4050	
000086	Blu Marino - Bullnose	Green			Each	T4055	
Pavigres	Verde 6" x 6"	True Green	45	22.5	11.25	T4224	
	Verde - Bullnose	True Green			Each	T4226	
000082	Blu Elettrico 6" x 6"	Dark Blue	46	23	11.5	T4250	
000087	Blu Elet. - Bullnose	Dark Blue			Each	T4251	
K-620	Royal Blue 6" x 6"	Royal Blue	44	22	11	T4384	
	Royal Blue - Bullnose	Royal Blue			Each	T4386	
K-638	Slate Gray - Bullnose 6" x 6"	Slate				T4018	
K-688	Teal Blue 6" x 6"	Teal Blue	44	22	11	T4066+	
	Teal Blue - Bullnose	Teal Blue			Each	T4625	
000083	Nero (Black) 6" x 6"	Black	46	23	11.5	T4095	
000088	Nero - Bullnose	Black			Each	T4068	
K-667	Matte Black 6" x 6"	Black	44	22	11	T4620+	
Pavigres	Black Bullnose	Black			Each	T4230	
000080	Blanco (White) 6" x 6"	White	46	23	11.5	T4048	
000085	Blanco Bullnose	White			Each	T4049	
Pavigres	Blanco (White) Bullnose	White			Each	T4234	

6" x 6" Design Tiles

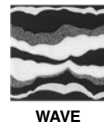

RP-02	Rope Series	Light Blue	44	22	11	T4056+
RP-89	Rope Series	Turquoise	44	22	11	T4254+
SA-90	Samoa Med Blue	Blue	44	22	11	T4062+
SS-32	Seven Seas 6" x 6"	Med. Blue	32	16	8	T4380+
SS-95	Seven Seas 6" x 6"	Pacific Blue	32	16	8	T4382
SS-41	Seven Seas 6" x 6"	Lake Blue	32	16	8	T4381
000093	Wave Blu Elettrico	Blue	46	23	11.5	T4005
M-6845	New Dolphin Series -3 Dolphin Design		32	16	8	T4600
M-6846	New Dolphin Series -Single Dolphin Design		32	16	8	T4602
M-6847	New Dolphin Series -Wave Design		32	16	8	T4604
HBLU(C30)	Tuscany Series	Pietra Azul	40	20	10	T4358
AZ606	Aztec Series	Cobalt	25	12.50	6.25	T4361

+Limited Stock

2" X 2" & 3" X 3" SQUARE TILE - FROST PROOF

PRODUCT DESCRIPTION	COLOR	SHEETS	LINEAR FT.	SQ. FT.	ITEM NO.
AMT-1760 2" x 2" Classic Grid	Glossy Grey	25	52	26	T4283+
HM-209 2" x 2" Classic Grid	Black	20	44	21.76	T4040
SQ-1022 2" x 2"	Black - Matt	30	65	32.70	T4284+
LJ071 2" x 2"	Black - Unglazed	25	50	25	T4630
SQ-2 2" x 2"	Black	25			T4041
HM-208 2" x 2" Classic Grid	White	20	40	21.76	T4244+
SQ-240 2" x 2" Classic Grid	Blue - Cobalt	30	65	32.64	T4043
HM-206 2" x 2" Harmony	Blue - Cobalt	20	44	21.76	T4032
IND-240 2" x 2" IND	Blue - Cobalt	20	44	21.76	T4030
HM-213 2" x 2" Harmony	Blue - Cobalt	20	44	21.76	T4035
HM-109 1" X 1" Harmony	Black				T4726
VGS202 1-3/8" x 1-3/8"	Blue - Terra	30	60	30	T4285+
NHP-150 2" x 2" Classic Grid	Mauve	25	58	28.75	T4245
CO-303 3" x 3" Cori Series	Grey	24	55	25.2	T4247+
HM-306 3" x 3" Harmony	Cobalt Blue	20	42	21	T4071
HM-310 3" x 3" Harmony	Blue - Royal	20	44	21.76	T4073
HS-344 3" x 3" Harmony	Lake Blue	20	42	21	T4366
HS-341 3" x 3" Harmony	Pacific Blue	20	42	21	T4368
RE-343 3" x 3" Reflection	Atlantic Green	20	44	21.76	T4302
RE-344 3" x 3" Reflection	Pacific Blue	20	44	21.76	T4304
M350 3" x 3" Marine Field	Cobalt Blue	20	40	20	T4370
DR350 3" x 3" Dakota	Blueberry	20	42	21	T4715
DK355 3" x 3" Dakota	Wheat	20	42	21	T4372
DK356 3" x 3" Dakota	Rushmore Blue	20	42	21	T4717
DSF-50 3" x 3" Discovery Series	Cobalt Blue	20	42	21	T4345
SMS-3CO 3" x 3" Sierra Mountain	Cobalt Blue	20	42	21	T4354
SMS-3AZ 3" x 3" Azul	Cobalt Blue	20	42	21	T4356

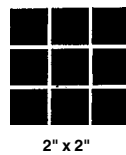

+Limited Stock

CUSTOM MOSAICS

Quality handcrafted ceramic mosaic tile designs to add life & character to any pool or spa.



Contact our office for a complete line of superior quality mosaics or even have your own design created.

4

CERAMIC DEPTH MARKERS
6" x 6" Smooth Tile

1/2

White Tile with Black Numbers

1/2	1	2	3	4	5	6	7	8	9	10	11	12	13
T4123	T4111	T4112	T4113	T4114	T4115	T4116	T4117	T4118	T4119	T4120	T4121	T4122	T4124

Blue Tile with Black Numbers (While Stock Lasts)

1/2	1	2	3	4	5	6	7	8	9	10	11	12	13
T4130	T4131	T4132	T4133	T4134	T4135	T4136	T4137	T4138	T4139	T4140	T4141	T4142	T4143

(1 Digits)

Green Tile with Black Numbers (While Stock Lasts)

1/2	1	2	3	4	5	6	7	8	9	10	11	12	13
T4150	T4151	T4152	T4153	T4154	T4155	T4156	T4157	T4158	T4159	T4160	T4161	T4162	T4169

(2 Digits)

CERAMIC DEPTH MARKERS
6" x 6" Non-Skid Tile

White Non-Skid Tile with Black Numbers

1/2	1	2	3	4	5	6	7	8	9	10	11	12	13
T4170	T4171	T4172	T4173	T4174	T4175	T4176	T4177	T4178	T4179	T4180	T4181	T4182	T4183

CERAMIC MESSAGE TILES
6" x 6"

6" x 6" White Tile "NO DIVING" Symbol

ITEM NO. SMOOTH	ITEMNO. NON-SKID
T4262	T4500

6" x 6" White Tile "NO RUNNING" Symbol (Non-Skid)

T4263

6" x 6" White Tile - "FT"

T4125 T4184

6" x 6" White Tile - "IN"

T4127 T4585



6" x 6" White Tile - "M" (Smooth) "1."

T4501 T4521

6" x 6" White Tile - "M" (Smooth) "2."

T4502

6" x 6" White Tile - "M" (Smooth) "0."

T4505

6" x 6" White Tile - "M" (Smooth)

T4260

6" x 6" White Tile - "M" (Smooth) "2M"

T4512

6" x 6" White Tile - "M" (Smooth) "5M"

T4515

6" x 6" White Tile - "M" (Smooth) "7M"

T4517

6" x 6" White Tile - "M" (Smooth) "8M"

T4518

6" x 6" White Tile - "M" (Smooth or Non-Skid) "9M"

T4519 T4520

6" x 6" White Tile - "NO DIVING" Message

T4264 T4186

6" x 6" White Tile - "FEET DEEP" Msg. (Non-Skid or Smooth)

T4128 T4126

6" x 6" White Tile - "NO RUNNING" Message (Non-Skid)

T4265



VINYL STICK-ON MESSAGES FOR DECKS

Self adhesive markers with skid resistance for deck surfaces.
More permanent than stenciling. Installs in minutes for professional look

Written Message Markers



		ITEM NO.
"NO DIVING" Symbol Stick-On Marker	6" x 6"	T4455
"NO RUNNING" Symbol Stick-On Marker	6" x 6"	T4457
"NO DIVING" Message Stick-On Marker	6" x 6"	T4456
"NO RUNNING" Message Stick-On Marker	6" x 6"	T4458
"FEET DEEP" Message Stick-On Marker	6" x 6"	T4459
"NO RUNNING" Message Stick-On Marker	6" x 6"	T4460
"FT" Single Vinyl Stick-On Marker	6" x 6"	T4461
"6 INCH" Message Stick-On Marker	6" x 6"	T4476
Installation Kit w/ Roller		T4400
Roller Only		T4404+
Spray Adhesive Only		T4406
Edge Sealer Only		T4408



+Limited Stock

White Vinyl Non-Skid Depth Markers with "FT"



0	1/2	1	2	3	4	5	6	7	8	9	10	11	12	13
T4420	T4421	T4422	T4424	T4426	T4428	T4430	T4432	T4434	T4436	T4438	T4440	T4441	T4442	T4443

New! - Make your own depth markers. Wingmaster deck marker stencil kit includes: Numbers 0-9, No Diving, Feet Deep, And Inches Deep. **Item: T4490**

White Vinyl Non-Skid Depth Markers with "M"

0	1	2	1M	2M	4M	5M	6M	7M	8M	9M
T4540	T4541	T4542	T4551	T4552	T4554	T4555	T4556	T4557	T4558	T4559

White Vinyl Non-Skid Depth Markers with "1/2"

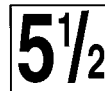

1-1/2	2-1/2	3-1/2	4-1/2	5-1/2	6-1/2	7-1/2	8-1/2	9-1/2
T4423	T4425	T4427	T4429	T4431	T4433	T4435*	T4437*	T4439*

*Non-Stock/Special Order Items

Large Message Vinyl Stick-Ons



No Diving	6" x 24"	T4450
No Running	6" x 24"	T4451



3/8" Foam Forms Press into Wet Concrete to Form Sumps for Deck Top Depth Markers or Messages!

- 6" x 6"
- 6" x 12"
- 6" x 18"

SAFETY GRIP BULLNOSE

Perfect for Replacing Existing Concrete Coping and New Pool Construction - Both Residential & Commercial

12-1/2" Safety Grip Bullnose Brick Pool Coping

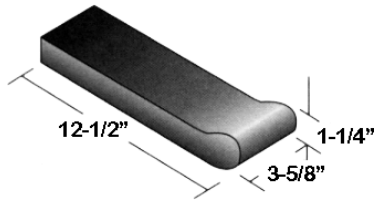

*Prices shown are for full pallets only
A charge of .20 per brick will be assessed for deducting or adding to pallet quantities

Please understand that there is a firm no return policy on brick coping. Be careful & order the correct color, type and quantity.

		ITEM NO.
		(320 Units/Pallet)
Color:	Sunset Red	Safety Grip T7010
	Pacific Rose	Safety Grip T7017+
	Burgundy	Safety Grip T7065
	Royal Saltillo	Safety Grip T7064
	Sterling Grey	Safety Grip T7018
	Rose Tan	Safety Grip T7029
	La Paz	Safety Grip T7061
	Pueblo	Safety Grip T7063
		(480 Units/Pallet) +Limited Stock
Color:	Plantation Red	Safety Grip T7135
	Havana Red	Safety Grip T7137
	Academy Grey	Safety Grip T7140
	Sunlit Earth	Safety Grip T7142
	Chino (Tan)	Safety Grip T7143
	Autumn Leaves	Safety Grip T7138
	Cobblestone Grey	Safety Grip T7139

STANDARD BULLNOSE COPING

12" Standard Bullnose - Kord (288 Units/Pallet)

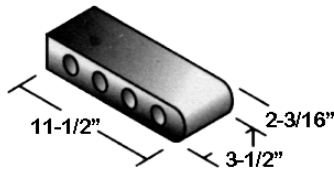

Color:	Sunset Red	12" SBN - Kord	T7000
	Burgundy	12" SBN - Kord	T7040
	Sterling Grey	12" SBN - Kord	T7001
	Saltillo	12" SBN - Kord	T7007
	Rose Tan	- Kord	T7009
	La Paz	- Kord	T7011
	Pueblo	- Kord	T7015

12" Solid Bullnose (405 Units/Pallet)

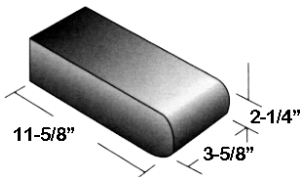

Color:	Plantation Red	- Solid Bullnose	T7110
	Havana Red	- Solid Bullnose	T7111
	Sunlit Earth	- Solid Bullnose	T7112
	Academy Grey	- Solid Bullnose	T7113
	Chino (Tan)	- Solid Bullnose	T7114
	Cobblestone Grey	- Solid Bullnose	T7116
	Autumn Leaves	- Solid Bullnose	T7118

9" Standard Bullnose - Kord (384 Units/Pallet)

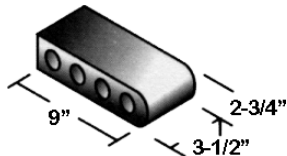

Color:	Sunset Red	- 9" SBN - Kord	T7002
	Pacific Rose	- 9" SBN - Kord	T7029+
	Burgundy	- 9" SBN - Kord	T7030
	Sterling Grey	- 9" SBN - Kord	T7003
	La Paz	- 9" SBN - Kord	T7016
	Pueblo	- 9" SBN - Kord	T7015

+Limited Stock

9" Solid Bullnose (540 Units/Pallet)

Color:	Plantation Red	- Solid Bullnose	T7115
(3-5/8" x 9" x 2-1/4")	Havana Red	- Solid Bullnose	T7117

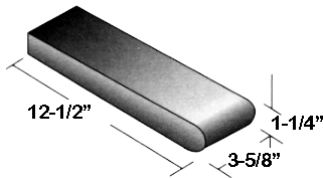

RETROFIT BULLNOSE

(3-5/8" x 12-1/2" x 1-1/4") Color: **Sunset Red** Retrofit

ITEM NO.
T7014
(560 Units/Pallet)

(3-5/8" x 11-5/8" x 1-5/8") Color: **Plantation Red** Retrofit

T7120

(3-5/8" x 11-5/8" x 1-5/8") Color: **Academy Grey** Retrofit

T7121

CORNER KITS 9" & 12"

	ITEM NO.
(12") Inside Corner Kit Color: Sterling Grey Safety Grip	T7060
(12") Outside Corner Kit Color: Sterling Grey Safety Grip	T7062
(9") Inside Corner Kit Color: Sunset Red Safety Grip	T7050
(9") Outside Corner Kit Color: Sunset Red Safety Grip	T7052
(12") Outside Corner Kit Color: Sunset Red Safety Grip	T7019

14" AUTO COVERS (SU)

		ITEM NO.
SU	-Straight for Auto Cover	T1140

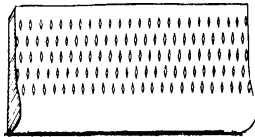

12" FIVE DIAMOND (GQ)

GQ	- Straight	T7021+
GQ	- Reverse Corner	T7024+
GQ	- 1 Ft Reverse Radius	T7026+
	<i>+Limited Stock</i>	

BRICK PAVERS

8" California Paver - Thin

3-5/8" x 1-1/4" x 7-5/8" (870 Units/Pallet)

Color: Sunset Red	T7012
Color: Brown	T7013

PL1072

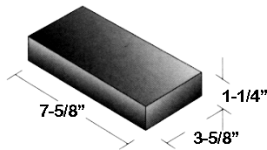

8" Standard Paver

3-1/2" x 2-3/16" x 7-1/2" (510 Units/Pallet)

Color: Sunset Red	T7004
Color: Sterling Grey	T7006
Color: Sunset Red (Die Skin)	T7067

One Side Smooth +Limited Stock

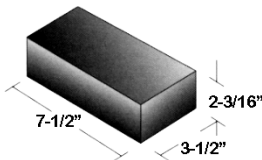

3-5/8" x 2-1/4" x 7-5/8" (560 Units / Pallet)

Color: Plantation Red	T7150
Color Academy Grey	T7160+
	<i>+Limited Stock</i>

Advance notice is needed for large & diverse radius orders. Other stones not listed may be available but not stocked.

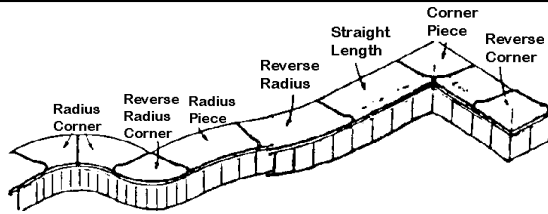

Coloring Available in 11 Colors
(2 Week Notice Required) 60% Upcharge

12" PLAIN SURFACE (AQ Style) Generic (Plain) Coping Stones

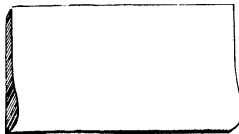

Plain Surface
2-3/4" x 1-1/4" Thick

		ITEM NO.
Straight	Coping Stone	T1110G
1' Radius	Coping Stone	T1111G
2' Radius	Coping Stone	T1118G
3' Radius	Coping Stone	T1112G
6' Radius	Coping Stone	T1117G
Inside Corner	Coping Stone	T1113G
Reverse Corner	Coping Stone	T1114G
1' Reverse Radius	Coping Stone	T1115G
3' Reverse Radius	Coping Stone	T1116G
Straight Coping Stone	w/1 6 x 6 Cut-out	T1168G
Straight Coping Stone	w/2 6 x 6 Cut-outs	T1169G
Straight Coping Stone	w/3 6 x 6 Cut-outs	T1170G

12" SINGLE DIAMOND (DV Style) Generic (Thin) Coping Stones

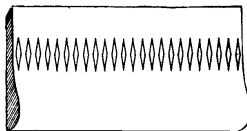

Single Diamond
2" x 1" Thick

		ITEM NO.
Straight	Coping Stone	T1100G
1' Radius	Coping Stone	T1101G
2' Radius	Coping Stone	T1107G
3' Radius	Coping Stone	T1102G
12' Radius	Coping Stone	T1130G
Inside Corner	Coping Stone	T1103G
Reverse Corner	Coping Stone	T1104G
1' Reverse Radius	Coping Stone	T1105G
3' Reverse Radius	Coping Stone	T1106G
Straight w/ 1 6x6 cutout	Coping Stone	T1161G
Straight w/ 2 6x6 cutout	Coping Stone	T1163G
Straight w/ 3 6x6 cutout	Coping Stone	T1165G

12" SINGLE DIAMOND (DQ Style) Generic (Thick) Coping Stones

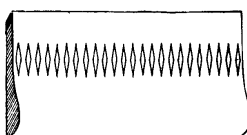

Single Diamond
2-3/4" x 1-1/4" Thick

		ITEM NO.
Straight	Coping Stone	T1120G
1' Radius	Coping Stone	T1121G
2' Radius	Coping Stone	T1128G
3' Radius	Coping Stone	T1122G
DQ #4	Coping Stone	T1133G
8' Radius	Coping Stone	T1132G
12' Radius	Coping Stone	T1127G
Inside Corner	Coping Stone	T1123G
Reverse Corner	Coping Stone	T1124G
1' Reverse Radius	Coping Stone	T1125G
Reverse Radius	Coping Stone	T1129G
3' Reverse Radius	Coping Stone	T1126G
Straight Coping Stone	w/1 6 x 6 Cut-out	T1160G
Straight Coping Stone	w/2 6 x 6 Cut-outs	T1162G
Straight Coping Stone	w/3 6 x 6 Cut-outs	T1164G
Right Side Zero Beach Entry		T1172G
Left Side Beach Entry		T1174G



SHEER DESCENT WATERFALL

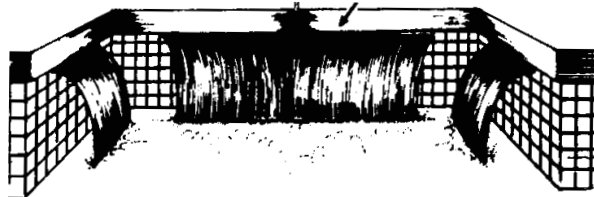

All Sizes
Not in Stock

Sheer Descent waterfalls produce a clear arc of water, projecting away from the pool wall. The flow can be adjusted to create a range of effects from an almost silent, glass like sheet of water to a rushing mountain spring waterfall. Injected molded PVC & uni-body construction

1" Standard Lip - (Back Feed)

		ITEM NO.
1 Foot	Waterfall - Soft White Lip	K1608R*
18"	Waterfall - Soft White Lip	K1609R*
2 Foot	Waterfall - Soft White Lip	K1610R*
3 Foot	Waterfall - Soft White Lip	K1612R*
4 Foot	Waterfall - Soft White Lip	K1614R*

*Special Order Item
- Add Freight



6" Extended Lip - (Back Feed)

6" extended lip waterfalls produce the same effect as the standard 1" lip, but allows for installation of brick or stone on the face of the raised beam.

1 Foot	Waterfall - Soft White Lip	K1617R
18"	Waterfall - Soft White Lip	K1618R
2 Foot	Waterfall - Soft White Lip	K1619B
3 Foot	Waterfall - Soft White Lip	K1621R
4 Foot	Waterfall - Soft White Lip	K1622R
6 Foot	Waterfall - Soft White Lip	K1632*

*Special Order Item
- Add Freight



1" Standard Lip - (Bottom Feed)

2 Foot	Waterfall - Soft White Lip	K1610
4 Foot	Waterfall - Soft White Lip	K1614

6" Extended Lip - (Bottom Feed)

18"	Waterfall - Soft White Lip	K1618
2'	Waterfall - 6" Extended Lip	K1619
3 Foot	Waterfall - Soft White Lip	K1621
4 Foot	Waterfall - Soft White Lip	K1622

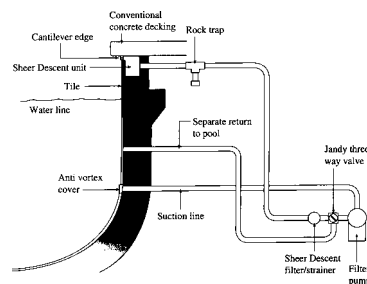
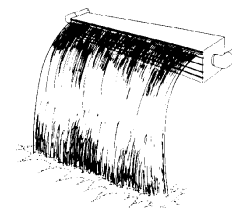

AQUA GARDEN

Durable & lightweight planter complete w/2 foot waterfall
Chemical & UV resistant. Dimensions - 38" x 15" x 15-1/2"

Jandy Aqua Garden - Color: White	K1650
Jandy Aqua Garden - Color: Terra Cotta	K1651

FOUNTAINS

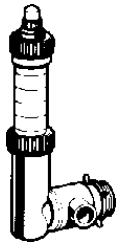

K1601



K1620

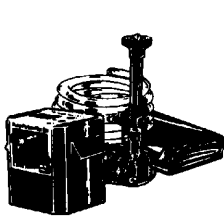

K1012

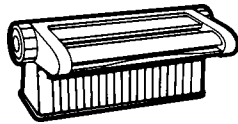

K1602

ITEM NO.

Polaris WaterStar WF

K1611

Connects at Polaris cleaner pool wall return.
Provides a choice of rainfall or waterfall sound.

Polaris WaterStar Fountain

K1620

Connects at Polaris cleaner pool wall return.
Floats anywhere you place it in the pool.

Polaris WaterStar 3 Tier Fountain Head

K1904

Aquaflower Floating 3 Tier Fountain

K1600

Hayward Deluxe WaterWall Fountain

K1601

Complete w/ base & valve for above ground pools

Hayward Funspray Adjustable Fountain

K1602

Multi-Spray adjustable fountain fits 1-1/2 FPT
for above ground or in ground pools

Little Giant Water Garden Kit

K1012

325 GPH Submersible Pump, 8' x 12' liner,
waterfall control/diverter valve & 3-tier spray.

DECK JETS

Can be mounted in the deck or pool wall

Polaris Mini Jets



K1660



K1661

Polaris #MJ10 Mini Jet Conversion Kit

K1665

With White Cover Plate, Screws, Comet nozzle

Polaris MiniJet w/ Comet Nozzle 3/8"

FFMJ

K1660

Polaris MiniJet w/ Fan Nozzle 3/8"

FFMJ-FN1

K1661

Polaris FFFJ-WM Fiberjet Wall Mount

K1662*

w/ Comet Nozzle 5-10T

*Non-Stock Item

Waterpik

Deck Jets #JDJ2004 (Set of 4)

K1663

Pentair

Deck Jet Assemble #580000

K1664

CUSTOM CASCADES

Water Features

The WaterFall

Available in a variety of materials, models & sizes.

ABS plastic comes in white, gray, tan or black.

Metal design in stainless steel, copper or brass.

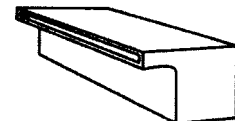
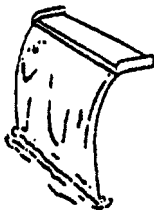

Spill Edge for Pool/Spa Combinations

Smooth flowing sheets of water for new or remodeled pool.

Choose from stainless steel, copper or brass. Custom sizes available with natural finish or patina finish to accent the tile.



ArcFall for Pools

Ideal for in-ground vinyl liner or gunite pools with no raised wall.

Custom Cascade will cut the coping for vinyl liner applications



For more information - Ask for a complete Custom Cascades Catalog

FIBERSTARS LIGHTED WATER FEATURES*Non-Stock Items***Lighted Laminar Flow Fountains**

A custom fiber application to utilize a low light output illuminator with spectacular results. Only lighted laminar shipped with fiber pre-attached. Works with all Fiberstars illuminators. Comes with 20' or 40' of fiber pre-attached.

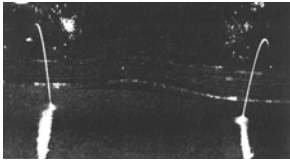

Fiberstars 6000 As Constant Color Illuminator	O2000
Fiberstars 6004 4-Color Illuminator	O2002
Fiberstars 2450-AS Constant Color Illuminator	O2004
Fiberstars 2004 4-Color Illuminator 410 Fiber Cap	O2008
Fiberstars RM-6000 Wireless Remote System For Lifetime Illuminator	O2010
Fiberstars RM-400 Self Contain Wireless Remote For 6600-AS	O2012
Fiberstars RM1 Wireless Remote For System 2450	O2014
Fiberstars Laminar Flow Fountains w/20' of Fiber	O2100
Fiberstars Laminar Flow Fountains w/40' of Fiber	O2105
Fiberstars Laminar Fountains w/40' of Fiber & Deck Box	O2115
Fiberstars Laminar Flow Fountains - Complete Kit	O2120

**Lighted Pots with Lighted Spillway**

These lightweight pots are easy to handle and designed for easy installation with a simple water supply and conduit for fiber. They include 45' of 50 strand fiber pre-attached and include a lighted fill/bubbler

Lighted Fiberglass Pots with Lighted Spillway Includes 45' of Fiber	O2130
---	-------

Lighted Spheres

For flush or inground installations. 8" diameter with outdoor poly-carbonate material. Stake or non-stake use. Comes with 45' of fiber pre-attached.

Fiberstars Lighted Sphere Kit w/45' of Fiber	O2135
--	-------

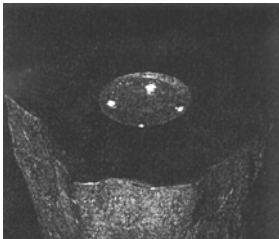
**Accessory Light Kit**

For small free standing fountains and preformed rocks etc. Includes 12 mini lens, 45' of fiber and quick connect fiber optic harness.

Fiberstars Accessory Light Kit	O2140
--------------------------------	-------

Lighted Rain Waterfalls

Paintable and bright. 5 different sizes. Least amount of fiber needed. Comes with 45' of fiber pre-attached. Easy conversion to 6', 7', and 8' sizes. Fiber is easily replaceable.

Fiberstars 1' Rain Waterfall w/45' of 24 Strand Fiber	O2151
Fiberstars 18" Rain Waterfall w/45' of 36 Strand Fiber	O2152
Fiberstars 2' Rain Waterfall w/45' of 48 Strand Fiber	O2153
Fiberstars 3' Rain Waterfall w/45' of 72 Strand Fiber	O2154
Fiberstars 4' Rain Waterfall w/45' of 96 Strand Fiber	O2155

**Bubbler Kit**

Provides an easy method of putting light into a small fountain or bubbler application. Comes with 45' of fiber pre-attached.

Fiberstars Bubbler Light Kit	Color: White	O2168
------------------------------	--------------	-------



PATIO CLOCKS



Y3060

Clock - Indoor/Outdoor 12" Cordless **Water Refraction** ITEM NO. Y3060

Clock - Indoor/Outdoor 12" Cordless **Color: Basic White** Y3061

Ziffy Clock - Colorful Clock that Displays Time, Temperature & Humidity Y3096+

Beautiful line of pool and patio clocks (not in catalog) available for retail stores and/or commercial pools. Display racks available. Priced from: Clocks \$11.75 - Thermometers \$6.99. Ask for catalog. - Special order only.



THERMOMETERS

Thermometer - Indoor/Outdoor 12" **Water Refraction** B1270

Thermometer - Indoor/Outdoor 12" **Color: Basic White** B1271

Thermometer - PoolMaster Outdoor 12" **Color: Decorative** B1272+

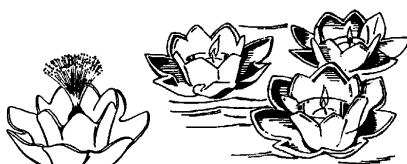

Y3047

Y3046

FLOATING LIGHTS

PoolMaster Blossom Lite - Assorted Colors Y3046

Swimline Blossom Lite - Single Colored Y3245

Glow Bouy Floating Rechargeable Pool Light O6030



DERBY DUCKS & TURBO TURTLES

Great American Derby Ducks - 6 Assorted Beak Colors B2000

Great American Derby Ducks - Glow in Dark (Assorted) B2005

Junior Derby Ducks (2/Bag; 6 Bags/Box) B2003



Great American Turbo Turtles - Assorted Colors B2035

Great American Turbo Turtles - Glow in Dark B2040

Jr. Glow Derby Duck - Counter Display B2015

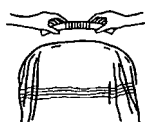

Y3066

FOOTBATH & TOWEL HUGGER

Foot Bath (Red or Blue Color) Y3095

Towel Hugger Y3066+
+Limited Stock

CANTAR PROTECT-A-POOL
In-Ground Removable Safety Fence

SPECIAL ORDER ONLY

- * Removes & Reinstalls in Minutes
- * Climb Resistant Surface

- * Exceeds OSHA Test Standards
- * Five-Year Warranty

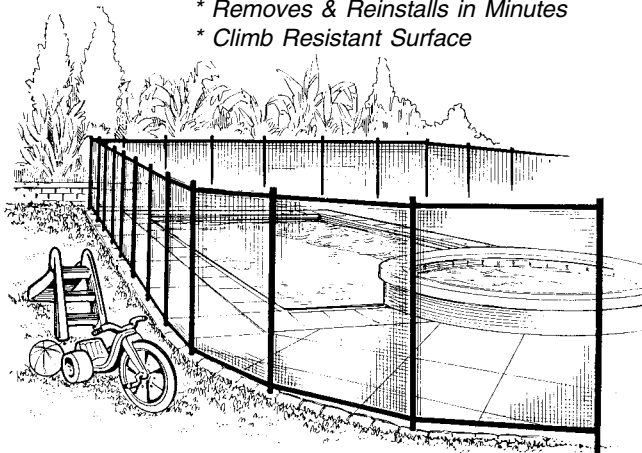

ITEM NO.

4' x 10' Fence Section **Black** W8100*

Drilling Guide W8166*
 *Non-Stock Item



SCOTCH TREAD - 18" Wide

Peel & stick roll of non-slip surface protection for slippery areas

Scotch Tread Cut to Size	Per Foot	G3110
Scotch Tread - 60' Roll		G3115
Non-Skid Pad for Ladder Tread	Each	H1247

ACCENT LIGHTING

Use submersed to highlight water features or out of water to illuminate feature landscape

Pond Glow Low Voltage Light & Transformer Kit K1026+

Includes: 12 volt, 20 watt submersible halogen light, mounting brackets,
 4 colored lenses, & weatherproof transformer with on/off timer.

+Limited Stock





PREVENT LASER

ITEM NO.

Prevent Laser Perimeter
Pool Alarm - Complete

V7500+

Includes: One Laser transceiver with adjustable stand, two reflectors with adjustable stands, two mirrors and one remote control. Prevent Alarm helps improve the safety of children and pets around your pool. Should they enter the beams path an alarm will sound.

Remote Control option

V7512+
+Limited Stock

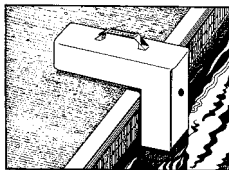

PGRM-2



POOL ALARMS

Pool Guard Alarm for In-Ground Pools
w/ Remote Receiver

PGRM-2

V7260

**Battery Powered, Completely Portable
Equipped with Sensitivity Adjustment Knob**

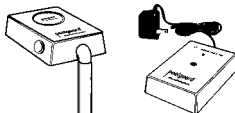

PGRM-AG

Pool Guard Alarm for Above Ground Pools
w/ Remote Receiver

PGRM-AG

V7264

**Includes: Indoor Remote Receiver
Battery Powered - Snaps onto Top Rail**

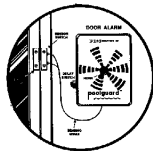

DAPT

Gate & Door Alarms

Pool Guard Door Alarm

DAPT

V7261

Pool Guard Gate Alarm

GAPT

V7263

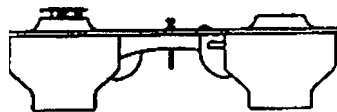

FLOATING POOL ALARMS

S.O.S. Floating Pool Alarm

V7265+

S.O.S. Floating Pool Alarm w/Remote

V7267+

Pool Patrol Door/Gate Alarm

GA-20

V7256

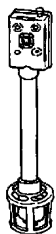

PS-08

SENTINEL POOL & SPA ALARMS

Sentinel Link Pool Alarm w/Remote

PS-08

V7270+

Sentinel Link Spa Cover Alarm

PS-10

V7276+

Sentinel Link Gate Alarm w/ Remote

PS-04

V7272+

+Limited Stock

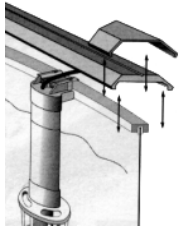

PE12

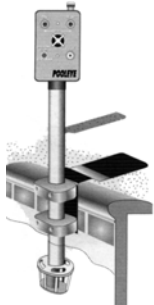

PE20



PE13

POOLEYE ALARM SYSTEMS

Uses rudder switch technology. Works under solar covers.



Pool Alarms

		ITEM NO.
Above Ground Pool Alarm System	PE12	V7606
Above Ground Pool Alarm System	PE13	V7616
In-Ground Pool Alarm System	PE20	V7610*
In-Ground Pool Alarm System w/Remote & Temperature Monitor	PE21	V7612
Smartpool Gate Alarm System	YG-03	V7614
PoolEye Perimeter Alarm System w/Underwater Sensor	PE22	V7618

*Non-Stock Item

STINGL SWITCH Emergency Pump Cut Off

Able to interrupt electrical power to pumps up to 3HP. Can also serve as a timer.

Model SR-500 Stingle Safety Shutoff Switch Residential or Commercial	SR-500	V7491
---	---------------	-------



E-MOD REPLACEMENT MOTORS FROM A.O. SMITH

An Alternative to Stingl Switches. E-MOD motors have an SVRS (Safety Vacuum Release System) built onto the motor that meets ASME Standards for suction entrapment avoidance. This should be an easy sale when a motor needs to be replaced. The average cost of the E-Mod motor is twice the price of a standard motor, so, for an additional \$150 to \$225, your customer would be protected with the very latest anti-entrapment product. Most models are in stock.

Flanged

1 HP

2 HP

Threaded

1 HP

1-1/2 HP



K5024M

K5025M

K5034M

K5036M



X4026 18" x 24"

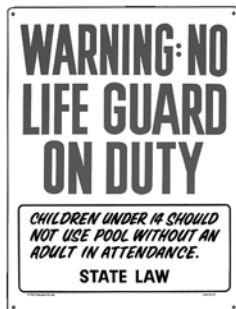

X4028 18" x 24"



X4046 18" x 24"



X4015 18" x 24"

POOL RULES & SIGNS



X4032 18" x 12"



X4024 18" x 12"



X4050 12" x 18"



X4022 18" x 12"

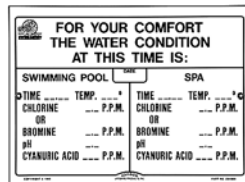

X4068 12" x 9"



X4025 12" x 18"



X4020 18" x 12"



X4040 18" x 12"



X4016 18" x 12"

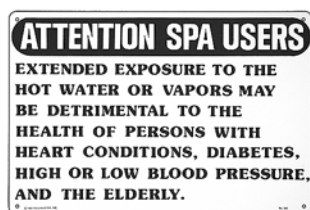

X4029 18" x 12"



X4060 12" x 18"



X4062 12" x 18"



X4056 12" x 18"



X4027

	ITEM NO.
Commercial Pool Rules	40322 X4026
Commercial Pool Rules	40324 X4030+
Caution Spa Users	#40360 X4055
Public Pool Regulations	40368 X4046
No Lifeguard on Duty	40323 X4028
Pool Rules - Above Ground	41370 X4050
Rules - Children's Animation	41335 X4034
Pool Closed	40333 X4032
Swim at Your Own Risk	40318 X4022
Attn: Spa Users	40365 X4029
Basic Life Support	40367 X4015
Saving a Life	40366 X4044
Water Conditions	R234500 X4068
Shallow Water - No Diving	40341 X4016
No Diving Allowed	40342 X4040
Caution No Diving	40344 X4025
Caution Diving Dangerous	40347 X4021
Above Ground No Diving	40346 X4017
No Running	40312 X4012
Keep Gate Closed	40316 X4020
No Food or Beverage	40369 X4048
No Glassware 6"x12"	41332 X4064
Shower Before Entering Pool	40320 X4024
Toilet Sign	41327 X4054
Who Peed in the Pool	41330 X4056
Urine Detector	41350 X4058
Welcome to Our "OOL"	41352 X4060
No Skinny Dipping #1	41353 X4061
No Skinny Dipping #2	41356 X4062
God Bless Our Pool	41340 X4038
Chemical Sign	B8772 X4027
Boys Sign	40314 X4018
Girls Sign	40315 X4019
Reserved For Tenants	40319 X4023
Not Responsible	41359 X4042

+Limited Supply

ROPE - Blue & White

Braided Polyethylene Rope



Poly Rope - **1/4" x 1000'**

Cut Per Foot

ITEM NO.

X1000

X1001

Poly Rope - **3/8" x 600'**

Cut Per Foot

X1005

X1006

Poly Rope - **1/2" x 600'**

Cut Per Foot

X1010

X1011

Poly Rope - **3/4" x 300'**

Cut Per Foot

X1015

X1016

HANDI-LOCK FLOATS



3" x 5" Blue & White - Lock Type Float for 3/8" Rope (50/Case) X1115

3" x 5" Red & White - Lock Type Float for 3/8" Rope (50/Case) X1114

3" x 5" Blue & White - Lock Type Float for 1/2" Rope (50/Case) X1116

5" x 9" Blue & White - Lock Type Float for 1/2" Rope (25/Case) X1119

5" x 9" Blue & White - Lock Type Float for 3/4" Rope (25/Case) X1120

5" x 9" Red & White - Lock Type Float for 3/4" Rope (25/Case) X1121

POLY ROPE FLOATS

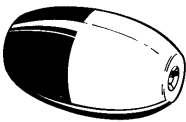

3" x 5" Blue & White Poly Float for 1/2" Rope (100/Case) X1095

3" x 5" Red & White Poly Float for 1/2" Rope (100/Case) X1096

3" x 5" White Only Poly Float for 1/2" Rope (100/Case) X1097

5" x 9" Blue & White Poly Float for 3/4" Rope (24/Case) X1100

5" x 9" Red & White Poly Float for 3/4" Rope (36/Case) X1101

5" x 9" White Only Poly Float for 3/4" Rope (36/Case) X1102

SAFETY FLOAT LINES

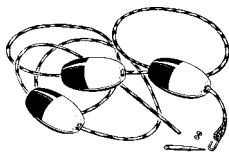

16' Safety Float Line w/ 5 Floats & 2 Hooks X1075

18' Safety Float Line w/ 5 Floats & 2 Hooks X1076

18' Safety Float Line w/ 7 Floats & 2 Hooks X1080

20' Safety Float Line w/ 9 Floats & 1 Hook Y1023

22' Safety Float Line w/ 7 Floats & 2 Hooks X1085

Sylvan Rope Kit - 20' with 3 Floats & 2 Sylvan Hooks X1086

ROPE HOOKS



Large 1/2" Chrome Rope Hooks (2/Bag) X1020

Large Chrome Rope Hooks (2/Bag) X1022
for 3/8" & 1/2" Rope
Cleat Type

Large Chrome Rope Hooks (2/Bag) X1021
for 3/4" Rope
Cleat Type

Large Chrome Rope Hooks (2/Bag) X1028
for 3/4" Rope
Cleat Type

Large Plastic Rope Hooks (Each) X1027
for 3/4" Rope

HOOK EYES



Small Hook Eye X1030
for 3/8" or 1/2" Rope

Large Hook Eye X1035
for 3/4" Rope

CLAMPS FOR HOOK EYES



3/8" Clamp for Hook Eye X1046
Chrome (2/Bag)

1/2" Clamp for Hook Eye X1048
Chrome (2/Bag)

3/4" Clamp for Hook Eye X1050
Chrome (2/Bag)

(For Rope Eyes & Anchors - Turn to Page 194)

RESCUE TUBES

Rescue Tube - 50" Water Park Tube
with Large Shoulder Strap



ITEM NO.
X1132

No Metal Clips or Buckles

RING BUOYS

Solid, closed-cell plastic construction throughout with weather resistant surface. Soft & resilient yet almost indestructible.

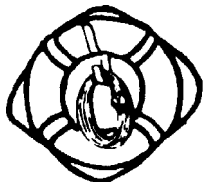

19"	Life Ring Buoy - USCG approved	X4004
24"	Life Ring Buoy - USCG approved	X4005
30"	Life Ring Buoy - USCG approved	X4006
20"	Life Ring (Non-U.S.C.G approved type)	X4002
	60' Lifeline w/ Ball	X4008

Help Line Throw Bag

60' - Bag HL Throw Bag X4011+
Cordura Nylon Bag. Ready to Use - Easily Thrown

RESCUE CAN



Rescue Can X1136
Storage Rack X1137

RESCUE POLES

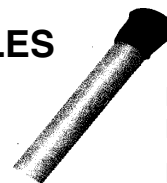

Rescue Pole - 12' F6000
Rescue Pole - 16' F6005
Repl. Cap for Pole F6090

LIFE GUARD PATCH



Embroidered Life Guard Patch - Loose Y3073

DIVING BRICK

"Official " Diving Brick - Rubber X4094



WHISTLES & LANYARDS

Classic FOX40



Plastic Fox 40 Whistle - Classic Y3076

Pealess whistle that cannot be overblown. The harder you blow the louder the sound. Assorted Colors: Blue, Orange, Yellow, Green, Pink, Purple, Red, Teal, Black & White

ACME

Thunderer



Acme Metal Whistle 60 1/2 Y3077

Nickle plated brass whistle made in England. Used by professional referees throughout the world.

Aristo Whistle & Lanyards



Metal Whistle 1-7/8" Long Y3074 /Dz
Lanyards - Misc. Colors Y3091 /Dz

UMBRELLA

Umbrella for Guard Chair H1195



LIFE HOOKS

Life Hook #9 - Clip On X1134
Life Hook #153 - Bolt On X1133



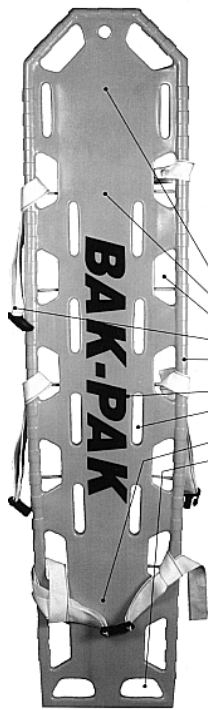

- Compatible w/Head Immobilizers
- Concave design
- 16 Hand Holds
- Complete w/Straps & Buckles
- Seamless Construction
- Custom Lettering Available
- 8 Child Strapping Locations
- Tapered for Confined Areas
- End Hand Holds for Safe Lift

DELUXE SPINE BOARDS

Yellow *BAK-PAK* Deluxe Spine Board ITEM NO. X1198

STRAPS FOR SPINE BOARDS

Heavy Duty Straps for Spine Board - Each X1193
 2" x 6'-6" Nylon Web with Delron Buckle

Velcro Strapping for Spine Board - Set of 3 X1196

Deluxe Spider Strap for Spine Board X1192

Bak-Pak Backboard Strap Kit X1199

HEAD IMMOBILIZERS



Head Immobilizer - X1194
 Use w/Spine Board for Complete Head Immobilization. Fits Small Children to Adults. Coated Foam

FIRST AID KITS



Commercial First Aid Kit ITEM NO. X1140

Travel First Aid Kit X1135

EXTRICATION COLLARS

ITEM NO.
 A one-piece, rigid extrication collar designed for patient safety. Injection molded w/velcro fasteners. Foam lining for comfort.



Small X1187
 Medium X1188
 Large X1189

EMERGENCY BLANKET

Bright yellow, waterproof, insulated, hygenic & disposable

Emergency Foil Blanket X1212

RESUSCITATION MASK

Prevents Direct Mouth-to-Mouth Contact

Pocket Mask X1186

"Ambu SPUR" Resuscitator Mask X1191



BLOODSPILL KIT

For safe & easy pick-up of body-fluid spills. Contains a scooper, a solidifier & sanitizer that congeals body fluid, a germicidal disposable cloth, a skin wipe that kills germs, a biohazard disposable waste bag & disposable latex gloves

Bloodspill Kit X1142

EYE AND SKIN WASH STATION KIT

Includes 2 16 oz. Bottles

Eye Wash Station X1138
 16 oz. Refill Bottles X1139

SPONGEX KICKBOARDS

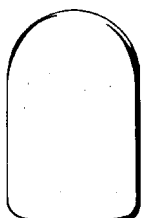

Spongex - Classic
Kick Board
12" x 21" x 1-1/4"
Red or Blue Color

ITEM NO.
X4091



Spongex - Champion
Kick Board
Revolutionary design promotes correct body positioning & form during training

X4096

SWIM TEACHER



#58 Swim Teacher

ITEM NO.

X1125

PULL BUOY



One Piece Custom Molded
Enhances upper body workout & hip rotation in both freestyle & backstroke

X4099

POOLMASTER SWIM BOARD

Compact Design with integral handles as swimming aid for intermediate developing skills



Swim Board - Comp/Trainer

X4087

JOGGER BELT

Comfortable for fitting belt for training, rehabilitation & everyday water aerobic workouts, - Adjustable



X4101

ZIFFY BOARDS

24" Ziffy Board w/Handles

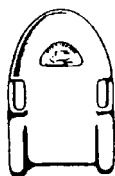

X4088

ADULT VINYL VESTS

Comfortable, Safe, Reliable & U.S.C.G. Approved

Adult X-Large
Chest Size 44" - 47"



Y4355+

+Limited Stock

FLOATING BABY SEAT

Floating Turtle Baby Seat
X4086



Made of unsinkable polystyrene. Designed to be tip resistant

CHILD SWIM VESTS

Not USCG Approved

Small Nylon Vest
Medium Nylon Vest



X4072

X4074

SWIM TRAINER

Training Suit (Ages 2 - 6) X4075
Boys Floatation Swimwear (Assorted Sizes) Y4370
Girls Floatation Swimwear (Assorted Sizes) Y4378
Aqua-Pal Swim Suit Small-Medium X4106



ARM FLOATS

Aqua Wings #9010 Y3290
Arm Floats #50501 X4084
Arm Floats #49008 X4092+



KIDDIE FLOAT

Child Swim Teacher



X4082

GOGGLES

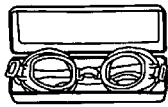

Y3369



Y3106

		ITEM NO.
Swimline "Buccaneer" - Kids	9306	Y3000
Swimline "Rio" - Kids w/Case	9309	Y3208
Swimline "St Lucia" - Youth/Adult	9318	Y3205
Swimline Crayfish Snorkel	9501	Y3228
PoolMaster Pro Sport	94560	Y3097
PoolMaster Pizazz II	94850	Y1011
PoolMaster Fog Free Silicone w/ Case	94750	Y3369
PoolMaster C2 Deluxe Water Sport	94900	Y3109
PoolMaster V-5 View w/ Case	94980	Y3106
Goggle Replacement Straps (3/Pack)	99053	Y3358

MASKS



Y3642



Y3211



Y2160



Y3144

Swimline "Newport" Mask - Youth	9456	Y3210
Swimline "Waikiki" Mask - Youth	9458	Y3011
Swimline "Manta Ray" Tri-View Mask	9474	Y3211
Swimline "Extreme" Tri-View Mask	9475	Y3643
PoolMaster "Mini Aviator" Child's Mask	90100	Y2160
PoolMaster "Majestic" Radial Deluxe Sport	90250	Y3124
PoolMaster "Magellan" Tri-View - Sport Mask	90270	Y3120
PoolMaster "Reef Diver" Scuba Sport Mask	90312	Y3140
PoolMaster "Mondeo" Pro Series Scuba Mask	90515	Y3142
PoolMaster "Zeus" Pro Series Scuba Mask	90540	Y3144

SNORKELS



Y3298



Y3231

Aqua Leisure Easy Flo Snorkel	E1378	Y3005
Swimline "Orca" Snorkel - Youth/ Adult	9502	Y3230
Swimline "Baja" Snorkel - Full Size	9504	Y3298
Swimline "Seabreeze" Swivel Snorkel	9503	Y3231
PoolMaster Maxi-Purge Sport Snorkle	92325	Y3384

FINS

**Springfield, Va. Only*



Voyager Sport Fins



Dolphin Pro Fins

Swimline "Voyager" Sport Fins	Size	(8-10)	Y3224
Swimline "Dolphin" Pro Style	Size	(5-7)	Y3270
Swimline "Voyager" Fins	Size	(5-7)	Y3283
Swimline "Voyager" Fins	Size	(6-7)	Y3284
Swimline "Voyager" Fins	Size	(8-9)	Y3285
Coral "Coronado" 1551	Size	(3-5)	---*
Aqua-Leisure Marina Shoe Fins	Size	(6-8)	Y3042
Aqua Explorer - Jr. Pro E5200	Size	(8-10)	---*

SWIMMING ACCESSORIES



Ear Plugs	9604	Y3092
Nose Clips	9601	Y3094
Swim Caps	9605	Y3287
Swimmer's Radio - Water Resistant	80800	Y3116
SOF-Flip Flops- Assorted Colors, Sizes, Styles	80800	Y4368

TEXAS RECREATION SUNSATON FLOATS

Constructed of closed-cell Ensolite foam & coated in colorful tough vinyl.

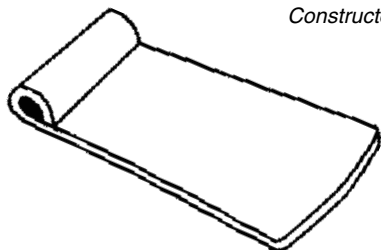

Sunsation Pool Float -	Yellow	ITEM NO.	Y1000
Sunsation Pool Float SS II -	Blue		Y1001
Sunsation Pool Float SS II -	White		Y1003
Econo II Pool Floats - Each			Y1080+
		Case of 4+	
Tote for Pool Float			Y1032+
			+Limited Stock

LOUNGES - POOLMASTER



Water Hammock



Caribbean



Tahitian



V.I.P. Tahitian

Water Hammock Lounger	70743	Y2070
All-Weather Fabric w/Inflatable Inserts		
Caribbean Floating Lounge	70727	Y1015
Full Body PVC Frame		
Tahitian Floating Lounge	70728	Y1009
Original Design		
V.I.P. Tahitian Luxury Lounge	70729	Y1012
Print Design		
V.I.P. Tahitian Luxury Lounge	70729S	Y1019+
Stripe Design		

+Limited Stock

AQUA ROLLER

Huge 57" high water wheel used as big roller or lazy fun float for three or four people. Rugges 14 gauge viny construction. Recommended for ages 8 years & older.

Aqua Roller Fun Float Y2115



FLOATATION CUSHIONS



Molly Brown	(Vinyl Covered)	33" x 72"	Y1049
-------------	-----------------	-----------	-------





Aqua Rocker



Classic Lounger



Islander Float



Azure Float-N-Deck

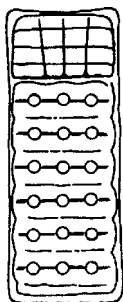

French Tufted



Twisty Snake Fun Float - Double

MATTRESSES & FLOATS

	MFG. NO.	ITEM NO.
Aqua Rocker Fun Float	86100	Y2114
Azure Float-N-Deck Lounger	85685	Y1017
Classic Floating Pool Lounger	85600	Y1076
French Tufted Lounge 28" x 74"	83360	Y1082
FunNoodle - UltraLite Foat		Y4096
Super Nylon Mattress	DSN-2976	Y1068+
Swimmaster Pool Float-Polyester <i>Self Inflating 24" x 70"</i>	86175	Y1041+
French Style Lounger	85660	Y1091
Zebra Air Mattress	83147	Y4607*

+Limited Stock
*Non-Stocked Item

BEACH BALLS



16" Beach Ball	81116	Y2132
24" Beach Ball	81124	Y2040
36" Beach Ball - Multiprint	81176	Y2091
46" Beach Ball	81146	Y2041
60" Beach Ball - Multiprint	81186	Y2042
Waterball Game 175 Sport Launcher Watergun (4/Case)	8520	B2013

AIR PUMPS



Y2084



Y2086

Large Foot Pump	87470	Y2084
Electric Air Pump 12-Volt	87491	Y2085+
Electric Air Pump 110-Volt	87493	Y2086



36" H.D. Water Fun Tube



Bump 'N' Squirt



36" Pool Tube



54" Giant Tube

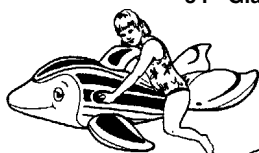

Dolphin Rider



Motorcycle Rider



Wave Rider

INFLATABLE TOYS

Swim Rings & Sport Tubes

	MFG. NO.	ITEM NO.
36" Pool Tube - Blue, Yellow & Red	87130	Y2047
36" Heavy Duty Water Fun Tube	87136	Y2055
42" Bump 'N' Squirt Tube <i>with Built-In Squirt Gun</i>	87210	Y2137
54" Giant Tube - "AquaFun" Print	87154	Y2170
Small Frenry Hippo		Y4604

Children's Riders

Body Board Surf Rider	85856	Y2069+
Dolphin Super Jumbo Rider	81760	Y2126
Mickey Mouse	93320	Y3252+
Shamu 60" Super Ride On	1011	Y4608+
Shark 72" Rider	9045	Y3641
Squirt Rider - 45" x 30"	KB50G	Y3359+
Motorcycle Super Jumbo Rider	81766	Y2124
Wave Rider Super Jumbo Rider	81769	Y2068

+Limited Stock

FUN NOODLES



Water Noodles	20/Case	Y4090
Water Log Connector - 2/Pkg.	12/Case	Y4091
	<i>Sold in Case Quantities Only</i>	
Water Log Super Connector	12/Case	Y4092*



*Non-Stocked Item

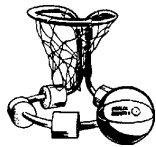

Y2000



Y2011



Y2003

BASKETBALL GAMES

	MFG. NO.	ITEM NO.
All Pro Basketball Game	72705	Y2000
All Pro Poolside Basketball Game	72780	Y2011
Classic Pro Basketball Game	72714	Y2007
Combo Basketball/Volleyball Game	72775	Y2014
Pro Action Basketball Game	72704	Y2034
Pro Rebounder Basketball Game	72793	Y2022
Splashback Poolside Basketball Game	72820	Y2024
Ziffco - No Shag Basketball Game	136A	Y2081
Classic Pro Poolside Basketball Game	72782	Y2021
Deluxe Water Sport Ball - Neon	72700	Y2003

WATER POLO & VOLLEYBALL GAMES

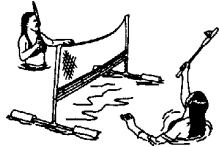

Y2006



Y2010

Across Pool Volleyball Game	72789	Y2019
Aqua Volley Ball Game	V200	Y2184
Floating Combo Volleyball & Badminton Game	72707	Y2006
Super Water Volleyball Game	72709	Y2017
Water Polo Game	72719	Y2010
Super Combo Volleyball	72708	Y2008

DIVING & MISC. GAMES



Y2012

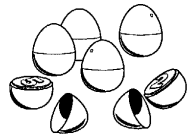

Y2020

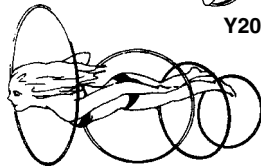

Y2018

3 in 1 Underwater Game	72733	Y2038
Deluxe Dive Rings	9135	Y2141
Dive Rings - Pack of 6	7273	Y2198
Deluxe Dive Discs	9131	Y2012
Dive Rings - Pack of 4	72711	Y2037
Deluxe Dive Sticks (New Lay Down Style)	72702	Y2004
Deluxe Ring Toss Game	9176	Y2009
Dolphin Slalom Game	72715	Y2018
Poolside Challenge - Floating Golf Game	72737	Y2002
Rotten Egg Game (12 Eggs)	72720	Y2020
Waterball Sport Launcher (Shoots Water)	8520	B2013



AQUATOY

AquaDisc (Glow) - Color: Blue & Green
Glow-in-the-dark disc for nighttime sports action fun

AquaDisc Fling - Color: Yellow & Orange
Lighter than original designed for shallow-end users ages seven & up.

AquaSkimmer - Color: Yellow Y4212
Soft 6" foam rubber disc skims the length of pool w/flick-of-the-wrist

AquaSkimmer Golf Includes AquaSkimmer & Goals
AquaDisc Hoop Underwater hoop only w/carry bag



Y4202

Y4204

Assorted Colors Y4210

3 Pack Y4214

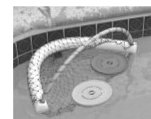

Y4220

Y4230

IN-GROUND SOLAR HEATING BLANKETS

		ITEM NO.
12' x 24'	In-Ground Solar Blanket	W5106
16' x 32'	In-Ground Solar Blanket	W5110
16' x 40'	In-Ground Solar Blanket	W5111
16' x 30'	In-Ground Solar Blanket	W5114
16' x 34'	In-Ground Solar Blanket	W5118
16' x 36'	In-Ground Solar Blanket	W5116
18' x 36'	In-Ground Solar Blanket	W5120
18' x 40'	In-Ground Solar Blanket	W5126
20' x 40'	In-Ground Solar Blanket	W5130
20' x 44'	In-Ground Solar Blanket	W5140
20' x 44'	In-Ground Solar Blanket	W5141
24' x 40'	In-Ground Solar Blanket	W5142
24' x 44'	In-Ground Solar Blanket	W5145
26' x 50'	In-Ground Solar Blanket	W5152
4' x 8'	Step Section	W5154



Custom Sizes * Per Sq. Ft. (F.O.B. Factory)

5-Year Limited Warranty (2-Year Full Replacement) Limited Supply

COMMERCIAL SOLAR BLANKETS

Custom Sizes - Available in 2' increment only. * per Sq. Ft. (F.O.B. Factory)
Please Specify Cover Length by Overall Pool Length

6-Year Limited Warranty (2-Year Full Replacement)

ABOVE GROUND SOLAR BLANKETS

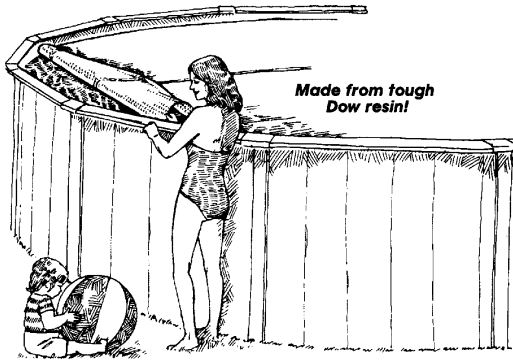

		ITEM NO.
12'	Round Solar Blanket	W5000
16'	Round Solar Blanket	W5010
18'	Round Solar Blanket	W5020
21'	Round Solar Blanket	W5030
24'	Round Solar Blanket	W5040
28'	Round Solar Blanket	W5050
30'	Round Solar Blanket	W5055
12' x 24'	Oval Solar Blanket	W5065
16' x 25'	Oval Solar Blanket	W5070
16' x 30'	Oval Solar Blanket	W5080
16' x 32'	Oval Solar Blanket	W5090
18' x 34'	Oval Solar Blanket	W5100
18' x 36'	Oval Solar Blanket	W5105

Custom Sizes Per Sq. Ft. (F.O.B. Factory)

3-Year Limited Warranty (One Year Full Replacement)



BUBBLE SPA BLANKETS

5' x 5'	Bubble Spa Blanket	W5202
6' x 6'	Bubble Spa Blanket	W5204
7' x 7'	Bubble Spa Blanket	W5206
8' x 8'	Bubble Spa Blanket	W5208
9' x 9'	Bubble Spa Blanket	W5210
10' x 10'	Bubble Spa Blanket	W5212



LIQUID SOLAR BLANKET

Floating invisible liquid which inhibits heat loss from evaporation

EcoSaver Solar Fish Liquid Blanket

W4900



FULL TEN YEAR WARRANTY!

ROCKY'S EAZY ROLLERS

Die Cast aluminum units come complete w/3" anodized tubing

Portable Solar Reel - For Pools up to 20' Wide	3AT-1	W2000
Portable Solar Reel - For Pools up to 24' Wide	3AT-2	W2005
Portable Solar Reel - For Pools up to 20' Wide	5AT-1	W2007
Portable Solar Reel - For Pools up to 24' Wide	5AT-2	W2009
Base Kit for W2007/W2009		W2031
AT-1 Tube Alone		W2032
AT-2 Tube Alone		W2034
Strap Kit w/ Grommets, Strap & Velcro		W2050

Cantar Solar Reel Replacement Parts

Replacement Parts for Cantar Solar Reel Systems

Set of 6 Wheels	W5296	White Protective Cover Sheet	W5161
Blanket Clips - 4/Bag	W5160	Wheel & Tube End Bearing	W5171
16' Strapping Kit	W5158	Black Nylon Yoke	W5178
25' Repair Tape	W5159		

COMMERCIAL REEL SYSTEMS

(*F.O.B. Youngstown, OH.)

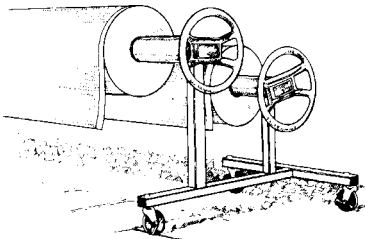

Dual Post Reel*

	REEL SIZE	BLANKET WIDTH	ITEM NO.
Dual Post Reel	16'	14'	W5190
Two Reels on one set	18'	16'	W5192
of 30" x 36" T-base stand	20'	18'	W5194
	22'	20'	W5196
	24'	22'	W5198
	26'	24'	W5199

*Ideal for large pools which require multiple blanket sections.
Can accomodate up to 200' blanket length (100' Each Tube)*

ODYSSEY SOLAR REELS

EMX Reel System

Most economically priced reel. Solid shock proof main frame with aluminum telescopic tubes. Fits pools up to 20 Ft. x 45 Ft.

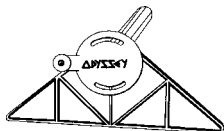

Solar Cover Roller for Pools **12' to 20'** W5548+

+Limited Stock

FeherGuard™ SOLAR REEL SYSTEMS

New Design

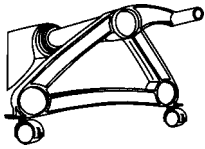

Blanket Handler Plus

Blanket Handler Plus

Three-way end for stationary placement, fence mounting & mobility with easy lock casters. Telescopic anodized tubes included. ITEM NO.

Blanket Handler Plus w/Telescopic Tube 14' to 20' W5448
(Max. Blanket Size 20' x 40')

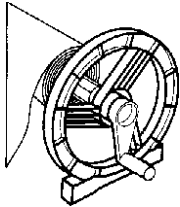

H. D. Wheels Reel

Wheels Reel

20" wheel ends for easy mobility, rolls over any surface. Wide track bearings w/ telescopic tube ends

H. D. "Wheels Reel" System for Pools up to 20' Wide W5432
(Max. Blanket Size 20' x 40')

H. D. "Wheels Reel" System for Pools up to 24' Wide W5433
(Max. Blanket Size 20' x 40')

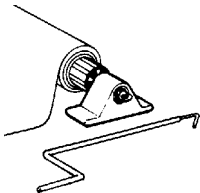

Low Profile

Low Profile

Allows for installation under diving boards with minimum of 10" clearance over deck level. For rectangular pools with square corners (6" radius or less).

Low Profile System for Pools up to 20' Wide W5436
(Max. Blanket Size 20' x 40')

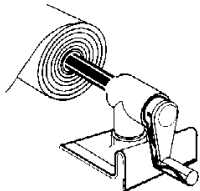

Surface Rider

Surface Rider

Reel system for above ground pools. Designed to roll up blanket while riding on surface of water. No drilling or screws in pool top rail.

Surface Rider Above Ground Reel up to 18' W5444
Surface Rider Above Ground Reel up to 24' W5446
Surface Rider Above Ground Reel up to 28' W5447

MISC. REEL COMPONENTS

Deluxe End Pak with 20" Wheels for Heavy Duty System	W5404
Deluxe LowProfile End Pak for Under Diving Board	W5406
End Pak for Above Ground Pools	W5405
Extension Tube for IG20 Tube to 24' - 6"	W5403
Extension Tube for Above Ground Reel up to 24'	W5409
Low Profile 20 Ft. Telescoping Tube Kit	W5407
White Protective Sheet 3' 1/2" x 24'	W5412
Tube & Blanket Fastening Kit	W5422
Tube & Blanket Fasteners (10 per pouch)	W5416
Blanket Strap Kit (2" x 54")	W5417
Mid Grip Pull Rope (35' rope, 2 clips& 2 straps per kit)	W5418

Cantor
SUMMER FUN[®]
 ABOVE GROUND POOLS

ESTATE
 ABOVE GROUND
 POOL KITS



48" & 52" wall made from deeply corrugated steel for superior strength. Estate walls feature Epoxilast coating for extra protection. Handsome Adobe/Stone finish applied with the exclusive Durocote process. 8" wide steel frame has 6-mil Plastisol coat for long lasting finish. Galvanized structural steel upright posts and top rails.

25 YEAR WARRANTY

Estate #I

ESTATE POOL KITS

48" Wall - No Liner

12' x 24' Oval Estate Pool Kit - 6 Boxes
 15' x 30' Oval Estate Pool Kit - 6 Boxes

ITEM NO.
 W8332*
 W8334*

**Non-Stock Item*

ALUMINUM BEAD RECEIVER

In Forestville MD. Warehouse

	ITEM NO.
For 18' A/G Pool	W4356
For 24' A/G Pool	W4300
For 24' to 32' A/G Pool	W4305
For 12' x 24' Oval A/G Pool	W4315
For 15' x 24' Oval A/G Pool	W4320*
For 15' x 30' Oval A/G Pool	W4325
For 18' x 33' Oval A/G Pool	W4330*
6" Radius Corner	W4332*
8' Angled Side Mount	W4334 15/cs.
8' Angled Side Mount Notched	W4336 15/cs.
8' Top Mount	W4352* 15/cs.
8' Top Mount Notched	W4354 15/cs.
5' Straight	W4358*

ABOVE GROUND POOL KITS

52" Wall - No Liner

	ITEM NO.
18' Round Chateau	W8204
24' Round Chateau	W8208*

**Non-Stock Item*

NOT ALL SIZES STOCKED

**CANTAR
OVERLAP LINERS**
Solid Blue - 20 Mil

DESCRIPTION

ITEM NO.

12' x 48 / 52" Round - Blue	W5780*
15' x 48 / 52" Round - Blue	W5782
18' x 48 / 52" Round - Blue	W5784
21' x 48 / 52" Round - Blue	W5786
24' x 48 / 52" Round - Blue	W5788
27' x 48 / 52" Round - Blue	W5790

**CANTAR
OVERLAP LINERS**
*Printed Bottom
- 20 Mil*

18' x 48/ 52" Round - Printed	W5984
24' x 48/ 52" Round - Printed	W5988
27' x 48/ 52" Round - Printed	W5990*
28' x 48/ 52" Round - Printed	W5991
15' x 30' x 48/ 52" Oval - Printed	W5994*
18' x 33' x 48/ 52" Oval - Printed	W5996*

NOT STOCKED IN FORESTVILLE, MD.

CANTAR BEADED LINERS
*48" Printed Liner
- 20 Mil*

18' Round Beaded Liner - Printed	W5351*
21' Round Beaded Liner - Printed	W5353
24' Round Beaded Liner - Printed	W5356*
27' Round Beaded Liner - Printed	W5361
12' x 24' Oval Beaded Liner - Printed	W5363*
15' x 30' Oval Beaded Liner - Printed	W5366*
18' x 33' Oval Beaded Liner - Printed	W5371

**TRIAC KAYAK
LINERS**
*- 25 Mil
Solid Blue*

12' x 24' x 48" Rectangle - Flat Bottom	W3650
16' x 24' x 48" Rectangle - Flat Bottom	W3654
16' x 32' x 48" Rectangle - Flat Bottom	W3658*



*Non-Stock Item

TRIAC OVERLAP LINERS

Solid Blue - PERMA 20



DESCRIPTION	ITEM NO.
12' x 48/ 52" Round - Blue	W3500
15' x 48/ 52" Round - Blue	W3501
18' x 48/ 52" Round - Blue	W3503
21' x 48/ 52" Round - Blue	W3505
24' x 48/ 52" Round - Blue	W3506
27' x 48/ 52" Round - Blue	W3507

12' x 24' x 48/ 52" Oval - Blue	W3515
15' x 24' x 48/ 52" Oval - Blue	W3519
15' x 30' x 48/ 52" Oval - Blue	W3522
16' x 24' x 48/ 52" Oval - Blue	W3525
16' x 32' x 48/ 52" Oval - Blue	W3526
18' x 33' x 48/ 52" Oval - Blue	W3528*

TRIAC OVERLAP LINERS

Printed Bottom - PERMA 20

*Rolling Rapids Wall &
New Illusions Bottom*

12' x 48/ 52" Round - Printed	W3540
15' x 48/ 52" Round - Printed	W3541
18' x 48/ 52" Round - Printed	W3543
21' x 48/ 52" Round - Printed	W3545
24' x 48/ 52" Round - Printed	W3546
27' x 48/ 52" Round - Printed	W3547

12' x 24' x 48/ 52" Oval - Printed	W3555*
15' x 24' x 48/ 52" Oval - Printed	W3559
15' x 30' x 48/ 52" Oval - Printed	W3562
16' x 24' x 48/ 52" Oval - Printed	W3565
16' x 32' x 48/ 52" Oval - Printed	W3566*
18' x 33' x 48/ 52" Oval - Printed	W3568*

TRIAC BEADED LINERS

Printed Bottom - PERMA 25

Gothic New Illusions



48" Liners

15' Round Beaded Liner - Printed	W3581
18' Round Beaded Liner - Printed	W3583*
21' Round Beaded Liner - Printed	W3585
24' Round Beaded Liner - Printed	W3586
27' Round Beaded Liner - Printed	W3587

12' x 24' Oval Beaded Liner - Printed	W3591
15' x 30' Oval Beaded Liner - Printed	W3593
16' x 24' Oval Beaded Liner - Printed	W3594*
16' x 32' Oval Beaded Liner - Printed	W3595
18' x 33' Oval Beaded Liner - Printed	W3596

52" Liners

Tile Border Printed Bottom

15' Round Beaded Liner - Printed	W3603
18' Round Beaded Liner - Printed	W3603
21' Round Beaded Liner - Printed	W3605*
24' Round Beaded Liner - Printed	W3606
27' Round Beaded Liner - Printed	W3607*

12' x 24' Oval Beaded Liner - Printed	W3615*
15' x 30' Oval Beaded Liner - Printed	W3622
18' x 33' Oval Beaded Liner - Printed	W3628*

*Non-Stock Item

HAYWARD ABOVE GROUND SAND FILTERS & SYSTEMS



S144T1540S



S180T



GM142HVB

Pro Series Top-Mount

		ITEM NO.
S144	14" 40 GPM Filter Only w/ 4 Position Valve	H6040
S144T1540S	14" Polymeric Filter & Pump System <i>Includes: 14" Filter w/ 4 Position Valve, Power-Flo 40 GPM Pump, Base & Hose Pack</i>	H6163
S166T92S	16" Polymeric Filter & Pump System <i>Includes: 16" Filter w/ 6 Position Valve, 1 HP Matrix Pump, Base & Hose Pack</i>	H6088
S166TPAKS	16" Sand Filter	H6123
S166T	16" Polymeric Filter Only w/ 1-1/2" Valve	H6039
S180T92S	18" Polymeric Filter & Pump System <i>Includes: 18" Filter w/ 6 Position Valve, 1 HP Matrix Pump, Base & Hose Pack</i>	H6086
S180T	18" Polymeric Filter Only w/ 1-1/2" Valve	H6033

GM Series Sand Filters

GM142HVB	14" Sand Filter Only with 6-Way Valve	H6023+
GM148B1540LSH	14" Sand Filter & Pump System	H6048+
	Modular Platform Base EC1161PAK <i>Pre-drilled for Power-Flo Series Pump</i>	H6004 + Limited Stock

HAYWARD POOL ACCESSORIES

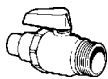

SP-729	Econoline Ball Valve <i>1-1/2 MPT x 1-1/2 / 1-1/4 Hose Connection Ideal for Above Ground Systems</i>	V4532
---------------	---	-------



SP-12T	Auto Timer <i>Pump Timer for Controlling Above Ground Systems. Self Closing, Rainproof Lid, Pump ON/Off Switch</i>	H6079
---------------	---	-------

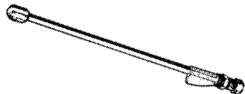

EC2024	Perflex Jet Action Cleaning Wand <i>Attaches to Garden Hose to Jet Clean Flex Tubes without Disassembly</i>	H6027
---------------	--	-------

HAYWARD MICRO STAR-CLEAR

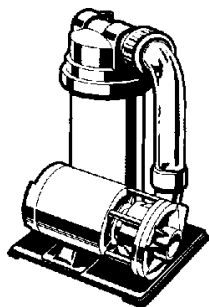

C2251540LSS

C2251540LSS Hayward Cartridge Filter System

*Includes: C-225 Cartridge Filter (25 Sq. Ft.)
Power-Flo Pump, Base, Hoses & 6' Cord*

ITEM NO.

H6044

C550-1575-XES Hayward Filter System

w/ 1 HP Pump and Base

H5001*

HAYWARD PERFLEX D.E. FILTERS



Extended Filtering Cycles



EC4075XESTL

EC40A Perflex Filter (20 Sq. Ft.)

w/Check Valve, Gauge & Deluxe 1-1/2" Drain Valve

H6078

EC4075XES Perflex EC40 Filter

w/ 1 HP Power-Flo LX Pump

Includes: Base, Union Connection & 1-1/2" Hose Package

H6011

EC50AC Perflex Filter (25 Sq Ft) (50GPM Flow)

w/ Clamp Style Closure Design

H6167

+ Limited Stock

* Non-Stock Item - Add Freight

JACUZZI LASER SAND FILTER SYSTEM

Swimming Pool Pump & Filter System - 115 volt Laser One-Piece Sand Filter with Top-Mounted Valve, LR Series Pump with 6' Cord. 5-Year Warranty

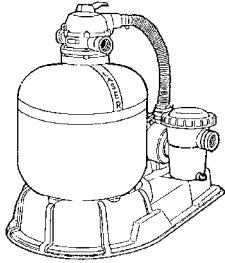

	ITEM NO.
19" Laser Sand Filter System with 1 HP LR Series Pump & 6-Way Valve (190L-S1LR6) - No Hose Kit	H9298+
19" Laser Sand Filter System with 1-1/2 HP LR Series Pump & 6-Way Valve (190L-I5LRDV) - No Cord	H9320+

+ Limited Stock

JACUZZI AVALANCHE D.E. FILTERS

Features straight vertical grids for more uniform flow with Ring-Lok design 10 Year Warranty



AV40	Avalanche D.E. Filter (40 GPM)	H9240
AV60	Avalanche D.E. Filter (60 GPM)	H9241
AV80	Avalanche D.E. Filter (80 GPM)	H9242+

+ Limited Stock

JACUZZI SHERLOK CARTRIDGE FILTERS

Newest Cartridge Filter in Jacuzzi Line. Features Easy Ring-Lok Access to Filter Element for Easy Servicing. No Tools Required. Includes Patented Dirt Catcher to Prevent Debris from Falling into Tank when Element is Removed. Five Year Limited Warranty

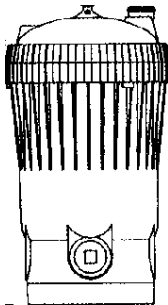

Sherlok 80	Cartridge Filter - 80 Sq. Ft. Element	H9217
Sherlok 120	Cartridge Filter - 120 Sq. Ft. Element	H9218
Sherlok 160	Cartridge Filter - 160 Sq. Ft. Element	H9222
Sherlok 200	Cartridge Filter - 200 Sq. Ft. Element	H9223

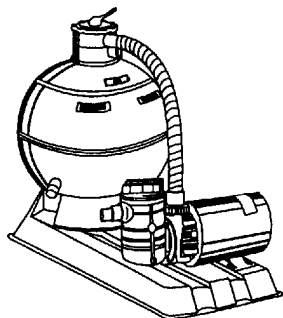

METEOR SAND FILTER SYSTEMS

All Meteor systems come with an 8 position multiport valve, 6' hose kit, 3' standard cord & on/off switch.

ITEM NO.

18" Meteor Filter w/ 3/4 HP Dynamo Pump

H3243+

+ Limited Stock

CLEAN & CLEAR CARTRIDGE SYSTEM

High quality filtration unit with thermoplastic chemical resistant tank. Equipped w/ easy spin-on unions for plumbing hook-ups.

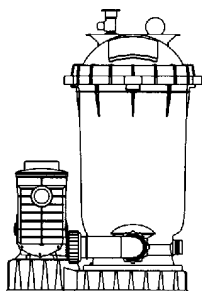

Clean & Clear 100 Sq. Ft. Cellular Media Filter

H3313*

**Clean & Clear 100 Sq. Ft. Filter System
w/ 1 HP Dynamo Pump**

H3316*

**Clean & Clear 100 Sq. Ft. Filter System
w/ 1-1/2 HP Maxim Pump**

H3320

Clean & Clear 150 Sq. Ft. Cellular Media Filter

H3317

*Non-Stock Item



CONFER
plastics inc.

IN-POOL PLASTIC LADDERS

ITEM NO.

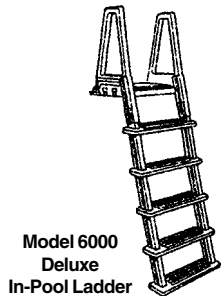

Model 6000
Deluxe
In-Pool Ladder

- New** Model 6100 Evolution Series *White* W3035
In-Pool Ladder for Decks up to 54"
- Model 6000 Heavy Duty In-Pool Ladder W5281
for 46" to 56" Pool Decks

A-FRAME LADDERS



Model 7100
A-Frame Ladder

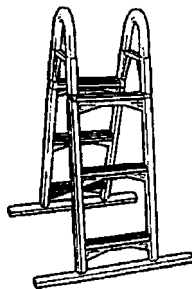

Model 36-A
A-Frame Ladder

- Model 7100W Evolution Series *White* W3037
A-Frame fits Pools 48" to 54"
- Model 36A A-Frame Ladder W5307
for 36" Pools/Deck - 13" Wide
- Model 7000 Deluxe A-Frame Ladder W3034
Adjusts to fit 48" & 54" Pools
22" High Handrails, Swing-up outer steps

- New** Model 736-52 Deluxe A-Frame Ladder W5288+
for 52" Pools

Conversion Kit W5380
Converts A-Frame to Deck Ladder

LP Ladder Pad W5381
*Flat pad rests under ladder
Cushions between pool liner & ladder*

EB100 3" Riser W5277
*Used to raise ladder 3" when deck
is built higher than pool. Straps to ladder*
+Limited Stock

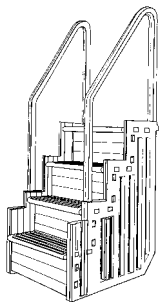

Confer STEP1
W2999

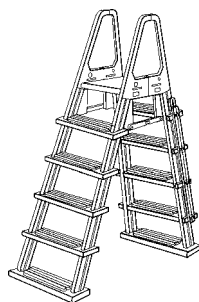

Model 7000
Deluxe A-Frame
Ladder

POOL ENTRY STEPS



EB100
3" Riser

PES-1 - Pool Entry System W3026
Adjusts to fit 48" & 54" Pools
10" x 27" Steps - For Above Ground

PES-DBL - Bridge System W1500
Confer Enclosure Kit W1505
Optional Gate for Pool Entry System W3033
when two PES-1 Units are Joined Together

STEP-CK Connector Kit W3028

The Wedding Cake Steps W5200
*Ornamental steps that can be
approached from front or the side.
Handrail can be adjusted to fit various
types of decks*

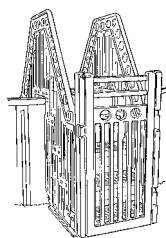

Optional
Gate

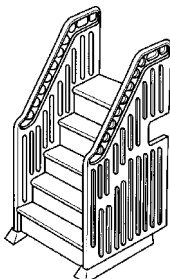

PES-1
Pool Entry system



The Wedding Cake
W5200

DOTLINE A-FRAME LADDERS

	ITEM NO.
Ladder Conversion Kit 2000C <i>Converts 2000A A-Frame Ladder to 2000D In-Pool/Deck Ladder</i>	W5228+
Model SPL-4 Safety A-Frame Ladder Aluminum for 48" Wall	W5257+
Model 3100 Blow Molded A-Frame Safety Ladder for 48" Wall	W5256+
Model 2000D Adjustable Blow Molded A-Frame Safety Ladder for 40"-54" Wall	W5226+
Misc. Replacement Treads Replacement Tread - Thru-Hole	W5259+

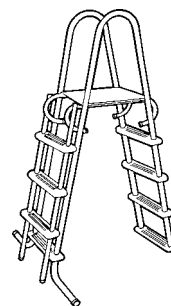

SPL-4 Safety
A-Frame Ladder



W5259
Ladder Tread

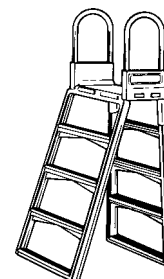

3100
A-Frame Ladder

+Limited Stock



SCOTCH TREAD - 18" Wide

Peel & stick roll of non-slip surface protection for slippery areas

Scotch Tread Cut to Size	Per Foot	G3110
Scotch Tread - 60' Roll		G3115
Non-Skid Pad for Ladder Tread	Each	H1247



AQUA-LUMINATOR
For Above Ground Pools

Aqua-Luminator Above Ground Pool Light

ITEM NO.

O1154

**Installs in standard wall return of pool wall
Fiberoptic ready, 20% brighter

Misc. Components

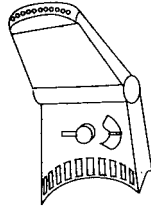

Aqua-Luminator Bulb Assembly

O1157

Aqua-Luminator Fountain Attachment
Snaps on light for added dimension

K1604

Pressure Cleaner Adapter for Aqua-Luminator

O1156

American AQL 500 ALG Light for Small Pools

O1158

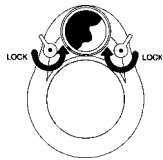

Pressure Cleaner Adapter

NITELIGHTER LIGHTING SYSTEMS
For Above Ground Pools



Ultra Nightlighter System

O1802

*Dual lighting mode (mood or high intensity)
12 volt (50 watt) transformer, 28' cord
Poolside control center. Easy installation*

Bulb Replacement Kit

O1803

50 Watt for Ultra Nightlighter



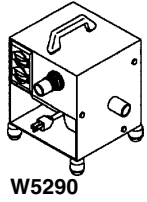

LINER VAC

"Mighty Vac" H. D. Vacuum/Blower	2.75 HP	115V	W5290
"Cyclone" Vacuum/Blower	3 HP	120V	W5262

ITEM NO.

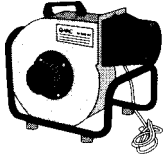

Q-VAC COMPLETE

Complete Liner Vac QV-1
Includes Q-Flex Hose
Pro Flow Liner Aide PF-36



W5297*

S4094
*Non-Stock Item

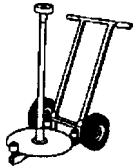

SMART CART

Cart for Above Ground Pool Walls
Saves time w/ less backbreaking installations

W8000*

*Non-Stock Item

LINER BEAD LOCK

120' Kit
3" x 4" x 4" - Each
T1578



POOL COVE

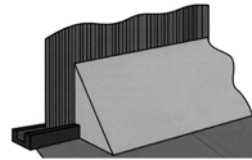

W5254

LINER LOCK

Side Mount
Liner Lock

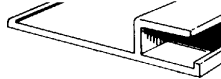
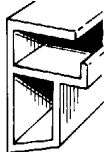

Wide - Top Mount
Liner Lock

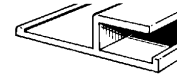

Narrow - Top Mount
Liner Lock

Side Mount Liner Lock		8' Pc.	T1746
Narrow Top Mount Liner Lock	1-1/2"	8' Pc.	T1747
Wide Top Mount Liner Lock	2-1/2"	8' Pc.	T1748

LINER HANGER

Liner Hanger 57" - Each
Bead Receiver 48" - Each

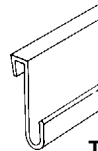

T1597

T1597
(Case of 56)
W8537+
(Case of 75)

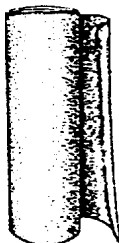

W3030
Wall Foam

WALL FOAM

1/8" x 42" 125' Wall Foam	W3030
1/4" x 42" 125' Wall Foam Backing	W3031

WALL ADHESIVE

Wall Spray Adhesive 17 Oz. Can

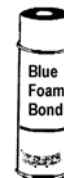

S4097
(Case of 12)

POOL BASE

Premix Cement & Pool Base Mixture 2 Cu. Ft. Bag W5252

We want your replacement liner orders!

We are your one stop shop for the replacement liners you do!

- * Stocking most replacement faceplates & gaskets for skimmers, inlets & drains!
- * Benefit from the volume discounts we receive by grouping your orders!
- * Stocking replacement coping & bead receivers in PVC & aluminum!
- * Benefit from freight discounts we receive when we ship multiple liners!
- * Stocking the tools you need to get the job done! (trowels, vacs, bead lock & more)
- * Benefit from the knowledge of a staff which has installed hundreds of vinyl liners!

Fax us pool dimensions & we'll be happy to supply you with an exact price

from the manufacturer of your choice!

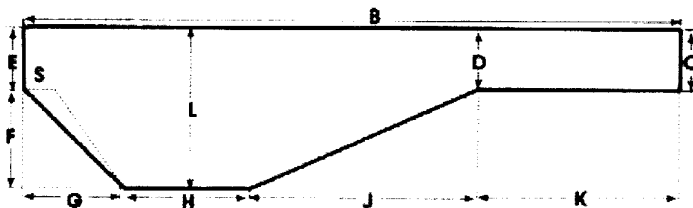



ON-GUARD WINTERIZING KITS

	ITEM NO.
7,500 Gallon Kit - 6/Cs. Contains: 1-3/4 lbs. Floating Winterizing Tablets 1 Pint Stain & Scale & 1 Qt. Winterizing Algaecide	A3931
15,000 Gallon Kit - 6/Cs. Contains: 1-3/4 lbs Floating Winterizing Tablets 1 Pint Stain & Scale & 1/2 Gal. Winterizing Algaecide	A3933
30,000 Gallon Kit - 2/Cs. Contains: 3-3/4 lbs. Floating Winterizing Tablets 1 Qt. Stain & Scale & 1 Gal. Winterizing Algaecide	A3936
30,000 Gallon Kit for Mesh Cover Pools - 2/Cs. Contains: 1 Quart Stain & Scale 1 Qt. Phosphate Remover & 1 Gal. Winterizing Algaecide	A3940

Misc. Winterizing Components

Multi Chlor Floating Chlorinator Only	12/Cs.	A4882
Foam Floater Collar for On Guard Winterizers	100/Cs.	A3938
Blue Devil Tall Chlorinator - holds 4lbs of tabs		C1072
IPS Enzymes Winterizer w/PhosControl - 1 liter / 34,000Gal.	12/Cs.	A6650
GLB Natural Clear 1 Gallon	4/Cs.	A5095

ANTIFREEZE & ALGAECIDES

Antifreeze - Gallons Calcium, Propylene Glycol Base **A9505**
Good to -15 Degrees (Green Liquid) (6 x 1 Gal.)

Antifreeze - Gallons Propylene Alcohol Base **A9502**
Good to -50 Degrees (Pink Liquid) (6 x 1 Gal.)

	QTY PER CASE	ITEM NO.
Jonas 10% Poly Winterizing Algaecide - Gallons 1 Gallon Treats 30,000 Gallons of Water	6/Cs.	AA1576
All Chlor 60% Poly Algaecide - Quarts	18/Cs.	A4856
All Chlor 60% Poly Algaecide - Gallons	6/Cs.	A4857
All Chlor 50% Quaternary Algaecide - Quarts	18/Cs.	A4860
All Chlor 1" Stabilized Chlorine Tablets - 50# Pail		A4226
All Chlor 3" Stabilized Chlorine Tablets - 50# Pail		A4267



SAFETY COVERS

Now offering Solid and Safety Covers from Two Manufacturers:



Secur-A-Pool® Safety Cover Systems

Secur&Clean® Solid Safety Cover Systems

PROMesh™ Mesh Safety Cover Systems

HyPerLite™ Solid Safety Cover Systems

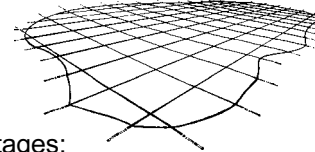

Purchasing through distribution offers many advantages:
 Tracking & Projected Arrival Dates, Quotes Called in within 24-48 hours,
 Lower Freight Rates, & Competitive Pricing.

Contact Us Regarding Pricing, Discounts, etc. On Special Items or Sizes.

CANTAR SAFETY COVER ACCESSORIES

DESCRIPTION	ITEM NO.
Stainless Steel Spring	CB1900
Stainless Steel Spring - Short	CB1901
Stainless Steel Spring - Commercial Grade	CB1905
Spring Protector - Vinyl	CB1924
Brass Anchors	CB1902
Brass Anchor Removal Tool	CB1903
Brass Anchor Collar	CB1916
Stainless Steel Buckles	CB1904
Aluminum Stakes	CB1906
Steel Installation Rods	CB1908
Anchor Key	CB1910
Storage Bag	CB1912
Wood Deck Anchors	CB1914
Stainless Steel Eye Bolt	CB1918
D-Rings	CB1920
Lawn Tubes	CB1922

LOOP-LOC SAFETY COVER ACCESSORIES

Installation Rod	BD3000
18" Anchor Key	BD3010
S.S. Spring w/out Slip Cover	BD3020
18" Aluminum Stake	BD3025
Brass Anchor	BD3030

MEYCO SAFETY COVER ACCESSORIES

Brass Pop-Up Type Anchor - Spring Loaded	CM1900
Brass Screw Type Anchor - Threaded	CM1902
Brass Wood Deck Anchor w/ Screws	CM1904
Pipe Anchor Assembly	CM1906
Stainless Steel Buckles	CM1914



Cantor
 A Q U A C O V E R®
WINTER COVER

“CLASSIC”

Custom Shapes and Sizes Available
On a Special Quote Basis!

Backed by a Strong 7 Year Warranty

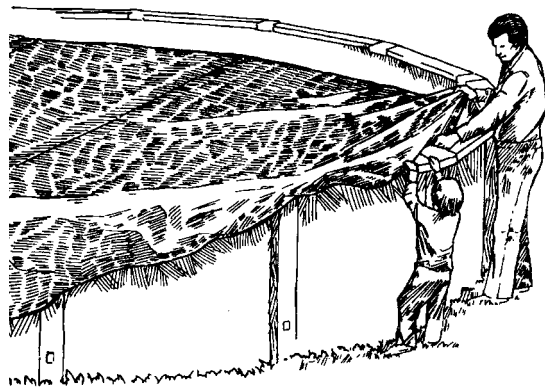

“ESTATE”

Custom Shapes and Sizes Available
On a Special Quote Basis!

Backed by a Strong 10 Year Warranty

AQUACOVER Blue/Black

POOL SIZE	COVER SIZE	ITEM NO.
12'	15'	CA0012
15'	18'	CA0015
18'	21'	CA0018
21'	24'	CA0021
24'	27'	CA0024
27'/28'	31'	CA0027
12' x 18' OV	15' x 21'	CA1218
12' x 24' OV	15' x 27'	CA1224
15' x 24' OV	18' x 27'	CA1524
15' x 27' OV	18' x 31'	CA1527
16' x 25' OV	19' x 28'	CA1625
15' x 30' OV	18' x 33'	CA1530
16' x 32' OV	19' x 35'	CA1632
18' x 34' OV	21' x 37'	CA1834

AQUACOVER Green/Black

POOL SIZE	COVER SIZE	ITEM NO.
12'	15'	CB0012
15'	18'	CB0015
18'	21'	CB0018
21'	24'	CB0021
24'	27'	CB0024
27'/28'	31'	CB0028
12' x 24' OV	15' x 27'	CB1224
15' x 27' OV	18' x 30'	CB1527
15' x 30' OV	18' x 33'	CB1530
16' x 25' OV	19' x 28'	CB1625
16' x 32' OV	19' x 35'	CB1632
18' x 34' OV	21' x 37'	CB1834



Cantar

A Q U A C O V E R[®]

WINTER COVER

“CLASSIC”

Custom Rectangles - L's & Lazy L's

Based on Cover Size

1 - 400 Sq. Ft. - .35

400 + Sq. Ft. - .32

Custom Shapes - Ovals & Kidneys

Based on Cover Size

1 - 400 Sq. Ft. - .47

400 + Sq. Ft. - .44

Classic Step Section \$30.00

Backed by a Strong 7 Year Warranty

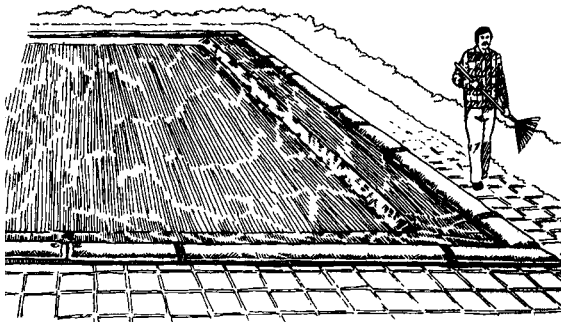

“ESTATE”

Custom Rectangles - L's & Lazy L's

Based on Cover Size

1 - 400 Sq. Ft. - .40

400 + Sq. Ft. - .37

Custom Shapes - Ovals & Kidneys

Based on Cover Size

1 - 400 Sq. Ft. - .55

400 + Sq. Ft. - .51

Estate Step Section \$38.00

Backed by a Strong 10 Year Warranty

AQUACOVER Blue/Black

POOL SIZE	COVER SIZE	ITEM NO.
16 x 32	21' x 37'	BA2137
16 x 36	21' x 41'	BA2141
16 x 40	21' x 45"	BA2145
18 x 36	23' x 41'	BA2341
18 x 40	23 x 45'	BA2345
20 x 40	25' x 45'	BA2545
20 x 44	25' x 49'	BA2549
24 x 40	29' x 45'	BA2945
24 x 44	29' x 49'	BA2949
25 x 50	30' x 55'	BA3055
30 x 50	35' x 55'	BA3555

AQUACOVER Green/Black

POOL SIZE	COVER SIZE	ITEM NO.
16 x 32	21' x 37'	BB2137
16 x 36	21' x 41'	BB2141
16 x 40	21' x 45'	BB2145
18 x 36	23' x 41'	BB2341
18 x 40	23' x 45'	BB2345
20 x 40	25' x 45'	BB2545
20 x 44	25' x 49'	BB2549
24 x 40	29' x 45'	BB2945
24 x 44	29' x 49'	BB2949
25 x 50	30' x 55'	BB3055
30 x 50	35' x 55'	BB3555

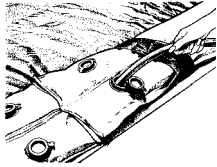

WATER TUBES

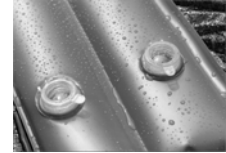

16 Mil (Single Chamber) Water Tube

	CASE QTY.	ITEM NO.
2 Ft. x 2 Ft. Corner Water Tube	N/A	DA1027
4 Ft. Single Water Tube - Blue	N/A	DA1023
8 Ft. Single Water Tube - Blue	25/Cs.	DA1025
10 Ft. Single Water Tube - Blue	25/Cs.	DA1030
8 Ft. Single Water Tube - Black	25/Cs.	DA1026
10 Ft. Single Water Tube - Black	25/Cs.	DA1031

16 Mil (Double Chamber) Water Tube

8 Ft. Double Water Tube - Blue	25/Cs.	DA1000
10 Ft. Double Water Tube - Blue	20/Cs.	DA1010
8 Ft. Double Water Tube - Black	25/Cs.	DA1005
10 Ft. Double Water Tube - Black	20/Cs.	DA1011

20 Mil (Single Chamber) Water Tube

8 Ft. Single Water Tube - Blue	25/Cs.	DA1035
10 Ft. Single Water Tube - Blue	20/Cs.	DA1040

20 Mil (Double Chamber) Water Tube

8 Ft. Double Water Tube - Blue	20/Cs.	DA1015
10 Ft. Double Water Tube - Blue	15/Cs.	DA1020
10 Ft. Double Water tube - Black	15/Cs.	DA1021

AIR PILLOWS



4 Ft. x 4 Ft. Air Pillow	15/Cs.	EE1030
4 Ft. x 8 Ft. Air Pillow	8/Cs.	EE1035
4 Ft. x 15 Ft. Air Pillow	4/Cs.	EE1040

GIZZMOS

Protects skimmers from the expansion of winter freeze up. Screws in place

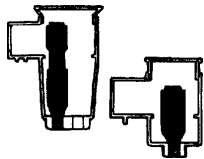

Regular 1-1/2"	24/Cs.	EE1070
Super New 1 1/2"- 2"	24/Cs.	EE1074

BLOW OUTS

Also protects skimmer by absorbing ice expansion Fits 1-1/2" & 2" skimmers - 16" Long

Suction Line Blowout Extension	12/Cs.	EE1080
Gizzmo Ultra Blowout Extension	24/Cs.	EE1075



WINTERIZING PLUGS WITH PLASTIC WING NUT



SIZE	FOR	ITEM NO.	SIZE	FOR	ITEM NO.
#00	1/2" P	FF1000	#08	1-1/2" P	FF1008
#01	1/2" P	FF1001	#09	1-1/2" P & 1-1/4" F	FF1009
#02	3/4" T	FF1002	#09-3/4	Deep for 1-1/2"	FF1009D
#03	3/4" P	FF1003	#09-3/4	Shallow for 1-1/2"	FF1009S
#04	3/4" & 1" P	FF1004	#10	1-1/2" F	FF1010
#05	1" T	FF1005	#11	2" P	FF1011
#06	1" P	FF1006	#12	2" F	FF1012
#07	1-1/4" P	FF1007	#13	2-1/2" P	FF1013



WINTERIZING PLUGS WITH BRASS WING NUTS



SIZE	FOR	ITEM NO.	SIZE	FOR	ITEM NO.
#06	1" P	FF1106	#9	1 1/2" P	FF1109
#07	1-1/4" P	FF1107	#11	2" P	FF1111
#08	1-1/2" P	FF1108	#12	w/Large Wing Nut	FF3012

COLORED WINTERIZING PLUGS

SIZE	COLOR	ITEM NO.	SIZE	COLOR	ITEM NO.
#04	Pink	FF5004	#08	Green	FF5008
#05	Red	FF5005	#09	Blue	FF5009
#07	Yellow	FF5007			

EXTENDED PLUGS WITH LONG BOLT & SPACER

SIZE	FOR	ITEM NO.	SIZE	FOR	ITEM NO.
#03	3/4" P	FF1030	#07	1-1/4" P	FF1070
#04	3/4" & 1" P	FF1040	#08	1-1/2" P	FF1080
#05	1" T	FF1050	#09	1-1/2" P & 1-1/4" F	FF1090
#06	1" P	FF1060	#10	1-1/2" F	FF1095
#06	1" P (1/2 Ext)	FF1065	#12	2" P	FF1097

P = PIPE T = TUBE F = FITTING

DOUBLE PLUGS

SIZE	LENGTH	DESCRIPTION	ITEM NO.
#7 - #10	8" Rod	Universal SINGLE Plug	FF1018
#8 - #8	8" Rod	Sylvan Double Plug	FF2088
#9 - #7	8" Rod	Sylvan Double Plug	FF2097
#9 - #8	8" Rod	Sylvan Double Plug	FF2098
#9 - #8	8" Rod, 1-1/4" Spacing	Anthony Double Plug	FF2100
#9 - #8	10" Rod	Anthony Double Plug	FF2198
#9 - #9	8" Rod	Anthony Double Plug	FF2099



PURGE PLUGS

SIZE	FOR	DESCRIPTION	ITEM NO.
#03	1-1/2" MPT	Plug-N-Purge	V5312
#07	1-1/4" Pipe	Expand-N-Purge	V5300
#08	1-1/2" Pipe	Expand-N-Purge	V5302
#09	1-1/2" Pipe & 1-1/4" Fitting	Expand-N-Purge	V5304
#10	1-1/2" Fitting	Expand-N-Purge	V5306
#11	2" Pipe	Expand-N-Purge	V5308



WEATHER-OUT HEATER COVERS



MFG. NO.	FITS HEATER	SIZE HEATER	ITEM NO.
WO200	Laars/Raypak	125 - 265 BTU	EE1076
WO400	Laars/Raypak	325 - 405 BTU	EE1077
WO200H	Hayward "H" Series	150 - 250 BTU	EE1078
WO400H	Hayward "H" Series	300 - 400 BTU	EE1079
WO200M	Minimax	150 - 250 BTU	EE1081
WO400M	Minimax	300 - 400 BTU	EE1082

WEATHER-OUT DIVING BOARD COVERS

MFG. NO.	DIVING BOARD SIZE	ITEM NO.
WO6DIVE	6' Diving Board	EE1083
WO8DIVE	8' Diving Board	EE1084
WO10DIVE	10' Diving Board	EE1085

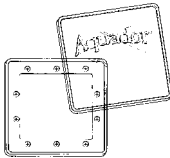

AQUADOR FACEPLATES WITH COVER

DESCRIPTION	FOR SKIMMER	ITEM NO.
Aquador 1090 Series	Hayward 1090, 1091, 1091EA, 1092, 1094, 1095ES, Olympic, American & Season Master	L4041
Aquador 1020 Series	Doughboy Skimmers	L4053
Aquador 1084 Series	Hayward Skimmers	L4054
Aquador 1085	Hayward 1085IBW Wide Mouth	L4056

GLADON COVER LOCK SYSTEM

DESCRIPTION		ITEM NO.
42" Cover Loc - 2 Part System	75 Sets/Case	EE3035
5" Cover Loc Jr. - 2 Part System	12 Sets/Bag	EE3038

MISC. EQUIPMENT

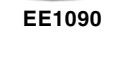
	Cap Plug for 2" Pipe	EE2010
	Cable & Winch	EE3034
	H.D. Repair Tape	W5159
	Easy Grip Knob	FF2000
	MouseAway Pouch - <i>Non Toxic</i>	EE1090
	Wingmaster Plus Tool	V7224
	Wingmaster Plus Service Kit	V7225
	Wingmaster Anchor Shell Extractor Kit	V7223



Close-outs! - Selling at Cost or Less

All Items In Limited Quantities

DESCRIPTION	ITEM NO.
Sta-Rite Max-E-Therm 200 BTU Propane Heater	J7010
Little Giant 12v Light Kit w/Transformer	K1026
Bronze Check Valve CXC - 1 - 1/2"	V1745
Bronze Check Valve CXC - 2"	V1750
Spring Check Valve PVC - 1 - 1/2" 2 psi	V3005
GLB In-Spa Fragrance 1 Pt. St. Moritz Sunrise - 12/Case	A5072
GLB In-Spa Fragrance 1 Pt. Mediterranean Breeze - 12/Case	A5074
GLB Stain Magnet System 6/Case	A5099
Leisure Time Sodium Bromide 6 / 2oz. Box	A5254
Hydrotech Cop-Out 12 pt./Case	A6412
Hydrotech Crystal Coat 24 - 1# Bags/Case	A6440
Hydrotech Crystal Coat 8 X 6#	A6442
Clear Comfort Stain Control 12 x 1Qt./Case	A7615
Clear Comfort Chlorine and Bromine Neutralizer 12 x 2#/Case	A7625
Vanson Sea Klear Bromine Spa Kit 4 X 1 kit /Case	A7740
Blue's Buddies Filter Gel *Great Deal@ \$1 each!!*	A8100
Adjust-A-Brush Pool Scrubber w/Knuckle & 48" Handle	F6800
Adjust-A-Brush Pool Scrubber w/Knuckle & Telescopic Pole	F6805
Astral IGP2025 2-1/2 HP Pump	K2109
Magnetek Motor Keyed Shaft 1/2 HP #B120 115/230V	K5000C
Magnetek Motor Keyed Shaft 3 HP #H740 3PH 208-230/460V	K5012C
Magnetek Motor Thru-Bolt 1 HP Low Run #BN38 115V	K5035C
Motor Horizontal Shaft 3/4HP 2-SP #A10 For PI Swp 115/230v	K5052
Wafer Valve - Steel 2" with Handle	V1420
Wafer Valve - Steel 2 - 1/2" with Handle	V1425
Odyssey Solar Cover Roller 12-20 Ft. #EMX	W5548

Letro and Polaris Common Parts

We offer these cleaner parts from both Letro (Pentair) and Polaris. You should use the chart below as a cross reference and a price comparison.

	Mfg. No.	Pentair Item No.	Polaris Item No.
Letro screw self tap #10 x 1/2" SS Pan Head (Bag of 5)	A30	E3A30	E2A30
Letro spring swing axle (Bag of 2)	C25	E3C25	E2C25
Letro screw 6-32 x 1/2" SS Pan Head (Bag of 5)	C32	E3C32	E2C32
Letro lock washer RO C36 (Bag of 5)	C45	E3C45	E2C45
Letro wheel washer (Bag of 2)	C64	E3C64	E2C64
Letro axle LG wheel	C66	E3C66	E2C66
Letro cover turbine	C97	E3C97	E2C97
Letro elbow for turbine cover or feed mast tube (2)	C98	E3C98	E2C98
Letro quick disconnect plug NPTM, plastic	D23	E3D23	E2D23
Letro quick disconnect female plastic	D26	E3D26	E2D26
Letro coupling 1-1/2" NPTFx 3/4" NPTM	G9	E3G09	E2G09
Letro disposable silt bag (4 pack)	G45	E3G45	E2G45
Letro volute	P5	E3P05	E2P05
Letro drive train gear kit	9-100-1132	E2571L	E2571
Letro axle block kit, front & rear	9-100-1139	E2542L	E2542
Letro turbine bearing	9-100-1103	E2628L	E2628
Letro feed pipe w/out timer	9-100-7003	E2605L	E2605
Letro impeller 3/4 HP	P15	E3P15	E2P15
Letro plug 1/8" NPTM	P20	E3P20	E2P20
Letro adjustment screw sweep hose	B20	E3B20	E2B20
Letro nut/bolt SS for volute to bracket (bag of 2)	P25	E3P25	E2P25
Pentair bag conversion kit w/bag, for polaris 380/360	9-100-1014	E2511L	E2511
Letro Leaf Bag	9-100-1012	E2519L	E2519
Pentair bag conversion kit w/bag, for polaris 280/180	K16	E3K16	E2K16
Letro belt kit small & large	9-100-1017	E2527	E2527
Letro E-clip SS (bag of 2)	9-100-5107	E2515L	E2515
Letro hub-cap	9-100-1114	E2520L	E2520
Letro collar bag tie	9-100-3135	E2574L	E2574L
Letro hose nut (bag of 2)	9-100-3109	E2534L	E2534
Letro feed hose 1 ft.	9-100-3103	E2584L	E2584
Letro sweep hose scrubber	9-100-3105	E2514L	E2514
Letro wheel bearing (bag of 2)	9-100-1108	E2540L	E2540
Letro wheel double side	9-100-1008	E2518L	E2518
Letro wheel single side	9-100-1116	E2521L	E2521
Letro leaf bag	K15	E3K15	E2K15
Letro bolt & nut 10-32 x 7/8" SS pan head (bag of 2)	C75	E3C75	E2C75
Letro sweep hose jet with collar	B25	E3B25	E2B25
Letro tune up kit	L205P	L205P	E2945
Letro quick disconnect hose kit	P17	E3P17	E2P17

Flange Bolt Chart

	Description	Size	Item#	Qty
1 - 1/2" Flange	Flange to Flange	3" Bolt		
2" Flange	Flange to Flange	3" Bolt	V2630	4 each
	Flange to Asahi	5" Bolt	V2650	4 each
	Flange to TVI	5" Bolt	V2650	4 each
	Flange to Astral	5" Bolt	V2650	4 each
2 - 1/2" Flange	Flange to Flange	3" Bolt	V2630	4 each
	Flange to Asahi	5" Bolt	V2650	4 each
	Flange to TVI	5" Bolt	V2650	4 each
	Flange to Astral	5" Bolt	V2650	4 each
3" Flange	Flange to Flange	3" Bolt	V2635	4 each
	Flange to Asahi	5" Bolt	V2650	4 each
	Flange to TVI	5" Bolt	V2650	4 each
	Flange to Astral	5" Bolt	V2650	4 each
4" Flange	Flange to Flange	3 - 1/2" Bolt	V2635	8 each
	Flange to Asahi	6" Bolt	V2657	8 each
	Flange to TVI	6" Bolt	V2657	8 each
	Flange to Astral	6" Bolt	V2657	8 each
5" Flange	Flange to Flange	3 - 1/2" Bolt	V2735	8 each
	Flange to Asahi	6" Bolt	V2736	8 each
	Flange to TVI	6" Bolt	V2736	8 each
	Flange to Astral	6" Bolt	V2736	8 each
6" Flange	Flange to Flange	3 - 1/2" Bolt	V2750	8 each
	Flange to Asahi	7" Bolt	V2736	8 each
	Flange to TVI	7" Bolt	V2736	8 each
	Flange to Astral	7" Bolt	V2736	8 each
8" Flange	Flange to Flange	5" Bolt	V2750	8 each
	Flange to Asahi	7" Bolt	V2736	8 each
	Flange to TVI	7" Bolt	V2736	8 each
	Flange to Astral	7" Bolt	V2736	8 each

****THICKNESS OF WASHER (2 ON EACH SIDE) = 1/4"**

Jandy Ray-Vac (Bagged Head Parts & Kits)	297
Jandy Ray-Vac (Bagged Hose Parts & Kits)	302
Jandy Ray-Vac Gunite Model	298-301
Letro Legend	303-304
Letro Legend II	305-306
Letro Legend 3 Wheel Model	307-308
Polaris 65 Vac-Sweep	309-310
Polaris 165 Vac-Sweep	311-312
Polaris 180 Vac-Sweep	313-316
Polaris 280 Vac-Sweep	317-319
Polaris 360 Vac-Sweep	320-323
Polaris 380 Vac-Sweep	324-325
Polaris Booster Pumps	326-327

JANDY RAY-VAC Bagged Head Parts & Kits

Complete Product on
page 58

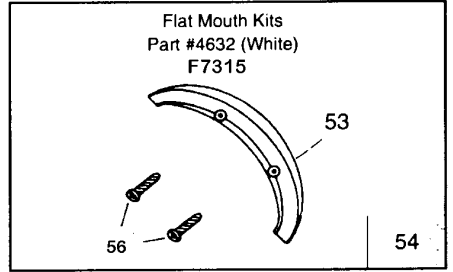
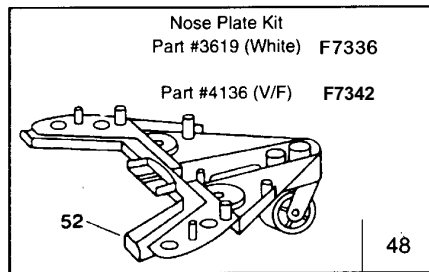
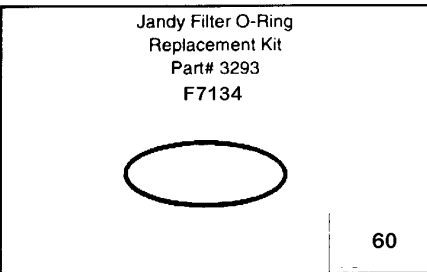
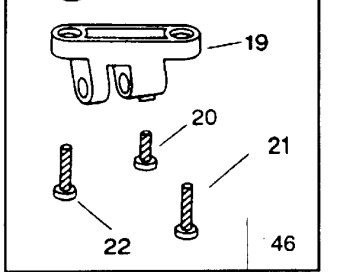
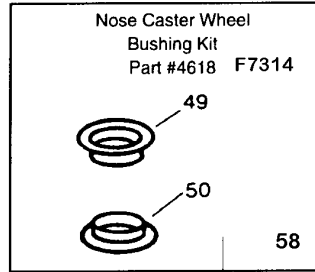
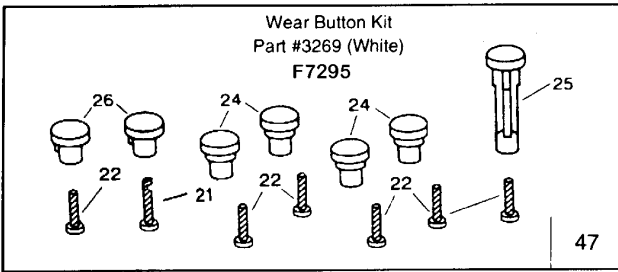
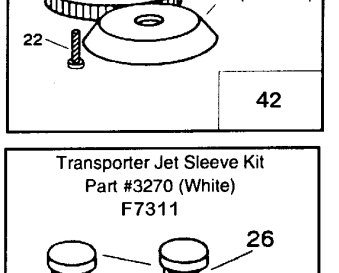
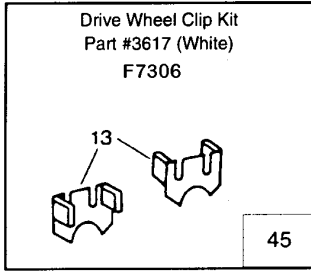
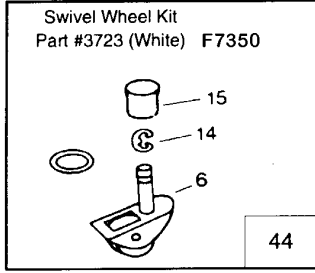
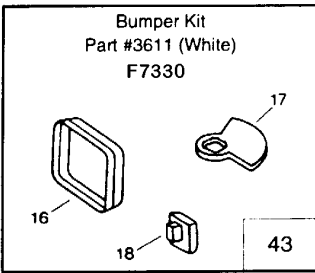
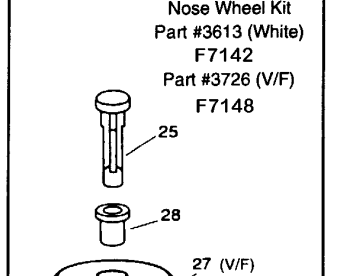
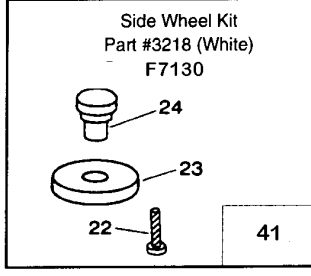
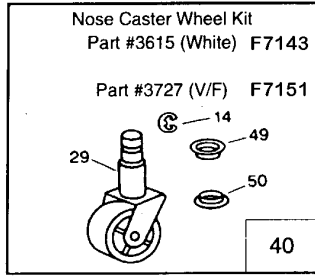
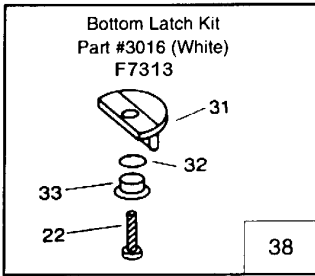
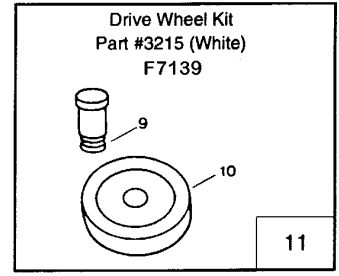
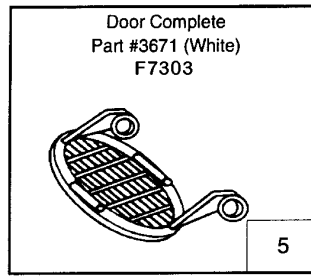
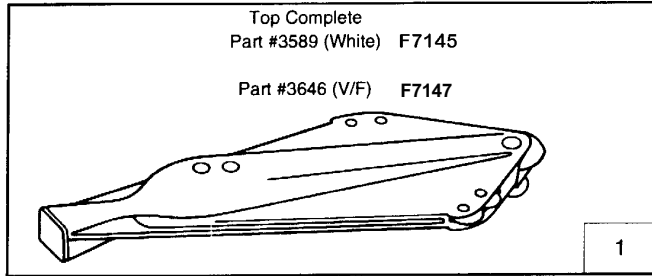

Cleaning Equipment

JANDY RAY-VAC
Automatic Pool Vacuum (Gunite Model)

Complete Product on
page 58

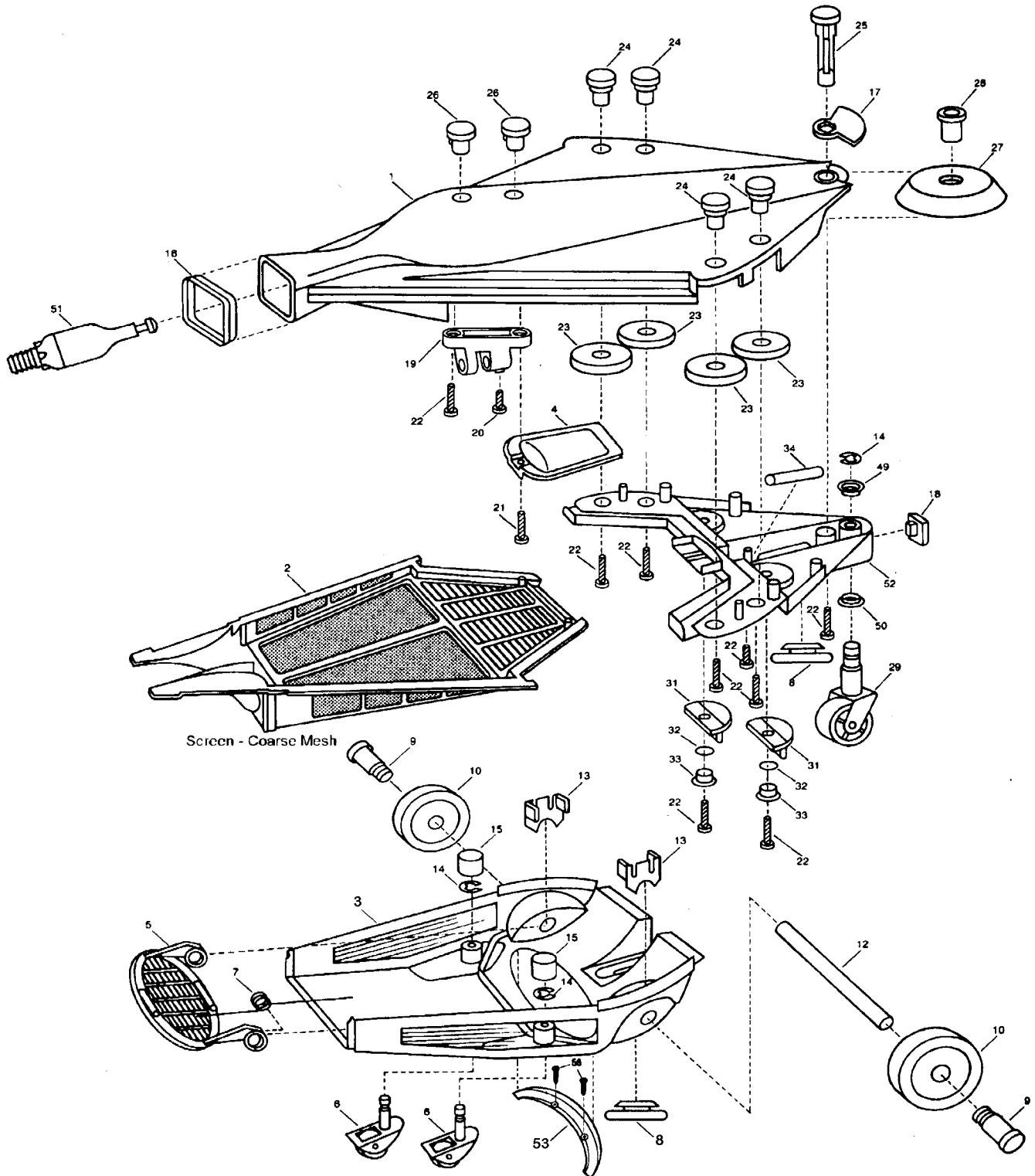

JANDY RAY-VAC Automatic Pool Vacuum (Gunite Model)

KEY	MFG NO.	KIT NO.	DESCRIPTION	ITEM NO.
1	3589	---	Ray-Vac Top - Complete (White)	F7145
2	3518	---	Screen - Complete	F7301
3	3590	---	Ray-Vac Bottom - Complete	F7325
4	2772	---	Float	F7302
5	3671	---	Ray-Vac Door - Complete	F7303
6	3555	3723	Swivel Wheel Complete *(Kit - Includes #14 & #15)	F7350 *
7	3539	---	Door Spring	F7304
8	2800	---	Wear Skid	F7260
9	2797	3215	Drive Wheel Hub *(Kit - Includes #10)	F7139 *
10	2796	3215	Drive Wheel *(Kit - Includes #9)	F7139 *
11	---	3215	Drive Wheel Kit *(Kit - Includes #9 & #10)	F7139 *
12	2798	---	Drive Wheel Shaft	F7305
13	3617	---	Drive Wheel Clip Kit	F7306
14	2746	---	E-Ring <i>(Not Sold Separately - Available Only in Kits)</i>	N/A
15	2794	3723	Wheel Housing Cover *(Kit - Includes #6 & #14)	F7350 *
16	3514	3611	Venturi Bumper *(Kit - Includes #17 & #18)	F7330 *
17	3512	3611	Nose Bumper Top *(Kit - Includes #16 & #18)	F7330 *
18	3513	3611	Nose Bumper Bottom *(Kit - Includes #16 & #18)	F7330 *
19	2776	3270	Transporter Jet Sleeve *(Kit - Includes #20 - #22 & #26)	F7307 *
20	1092	---	Screw #6 x 1/4", Triple-Dual Hold Kit, 2-Pack	F7317
21	2990	---	Screw <i>(Not Sold Separately - Available Only in Kits)</i>	N/A
22	1409	---	Screw #6 x 1/2" Type 25	F7310
23	2808	3218	Side Wheel *(Kit - Includes #22 & #24)	F7130 *
24	2809	3218	Axle for Side Wheel *(Kit - Includes #22 & #23)	F7130 *
25	2806	3613	Nose Wheel Axle *(Kit - Includes #22, #27 & #28)	F7142 *
26	2810	3270	Trans Jet Wear Button *(Kit - Includes #19 thru #22)	F7311 *
27	3521	3613	Nose Wheel *(Kit - Includes #22, #25 & #28)	F7142 *
28	2841	3613	Wheel Axle Bushing *(Kit - Includes #22, #25 & #27)	F7142 *
29	3363	3615	Nose Caster Wheel *(Kit - Includes #14, #49 & #50)	F7143 *
31	2799	3016	Bottom Latch *(Kit - Includes #22, #32 & #33)	F7313 *
32	2814	3016	Latch O-Ring *(Kit - Includes #22, #31 & #33)	F7313 *
33	2840	3016	Latch Washer *(Kit - Includes #22, #31 & #32)	F7313 *
34	3533	3619	Nose Weight *(Kit - Includes #52)	F7336 *
38	---	3016	Bottom Latch Kit *(Kit - Includes #22, #31 thru #33)	F7313 *
40	---	3615	Nose Caster Wheel Kit *(Kit - Includes #14, #29, #49 & #50)	F7143 *
41	---	3218	Side Wheel Kit *(Kit - Includes #22 thru #24)	F7130 *
42	---	3613	Nose Wheel Kit *(Kit - Includes #22, #25, #27 & #28)	F7142 *
43	---	3611	Bumper Kit *(Kit - Includes #16 thru #18)	F7330 *
44	---	3723	Swivel Wheel Kit *(Kit - Includes #6, #14 & #15)	F7350 *
45	---	3617	Drive Wheel Clip Kit *(Kit - Includes #13)	F7306 *
46	---	3270	Transporter Jet Sleeve *(Kit - #19 thru #22 & #26)	F7311 *
47	---	3269	Wear Button Kit *(Kit - #21 & #22, #24 & #25)	F7295
48	---	3619	Nose Plate Kit *(Kit - #Includes #52)	F7336 *
49	3509	---	Wheel Bushing - Top <i>(Not Sold Separately - Available in Kits)</i>	N/A
50	3510	---	Wheel Bushing - Bot <i>(Not Sold Separately - Available in Kits)</i>	N/A
51	2777	---	Transporter Jet Complete	F7251
52	4618	3619	Nose Plate Kit	F7336 *
53	4107	---	Flat Mouth (White) <i>(Not Sold Separately - Available in Kits)</i>	N/A
54	---	4632	Flat Mouth Kit *(Kit - Includes #53 & #56)	F7315
56	4301	---	Screw #4 x 5/16" Phil S.S.	F7316
58	---	4618	Nose Caster Wheel Bushing Kit *(Kit - Includes #49 & #50)	F7314 *
60	---	3293	Filter O-Ring Replacement Kit	F7134

JANDY RAY-VAC
Automatic Pool Vacuum (Gunite Model)

Complete Product on
page 58



A Teledyne Laars Company

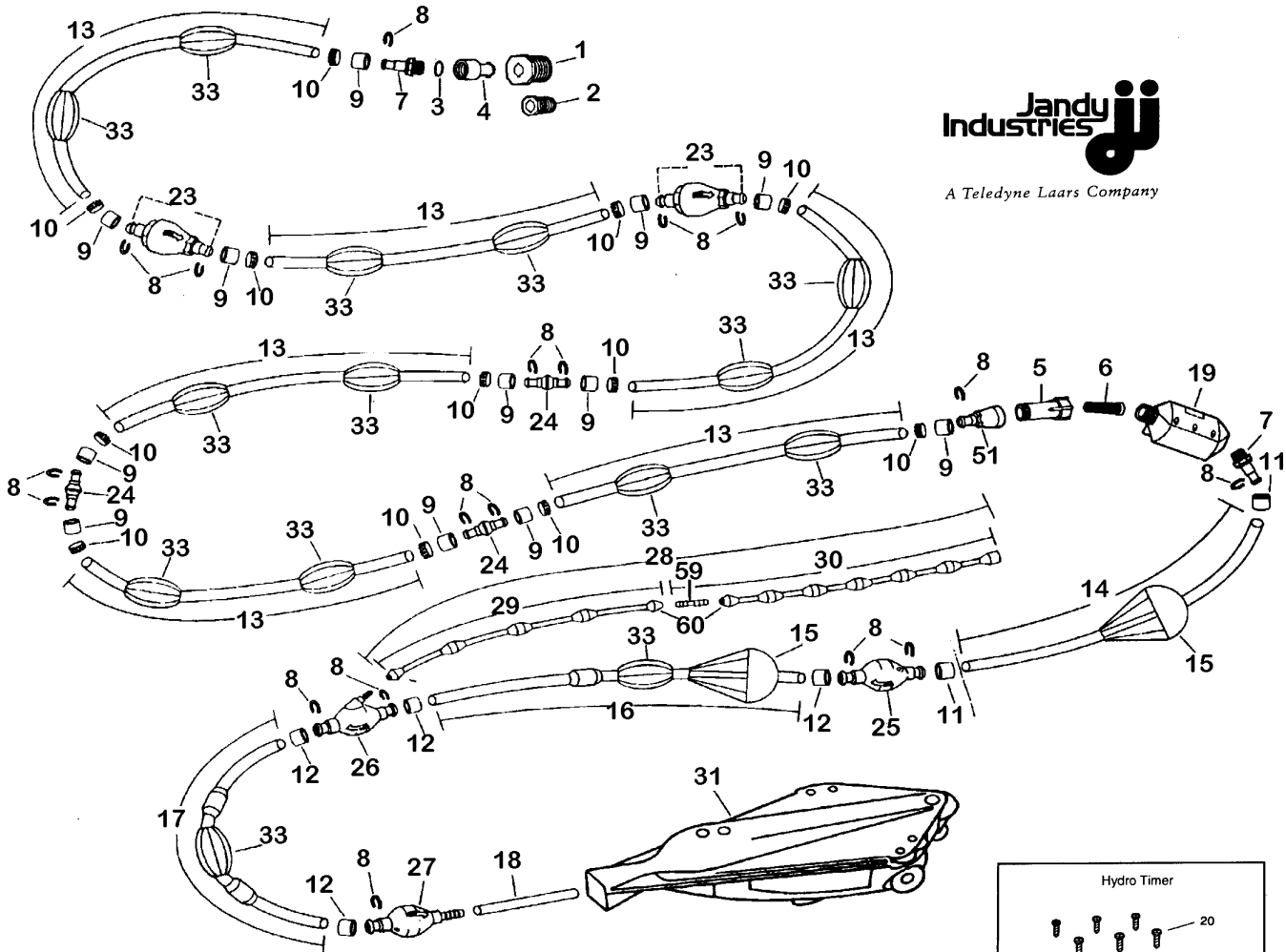

Speed Adjustment Kit
F7270
Part #2931 32

Jandy Filter w/Gauge and Valve
F7140
Part #2887 43

Whip Jet Kit
Part #3225
F7334
42

Hydro Timer
Part #4296 19

Corner Kit
Part #3266 F7294
61

Swivel Rebuild Kit
Part #4047 F7381
52

Mender Sleeve Retaining
Clip Kit #4143
F7337
56

Jandy Filter w/Gauge
Part #2888 50

JANDY RAY-VAC Hose Parts (Gunite Model)

KEY	MFG NO.	KIT NO.	DESCRIPTION	ITEM NO.
1	3782	5532	Q.D. Wall Fitting, 1-1/2" *(Kit - Includes #2 & #4)	F7326 *
2	3783	5532	Q.D. Wall Fitting, 3/4" *(Kit - Includes #1 & #4)	F7326 *
3	1138	---	Garden Hose Washer Kit, 3-Pack	F7318
4	3784	5532	Quick Disconnect Coupler *(Kit - Includes #1 & #2)	F7326 *
5	1098	---	Filter Screen Case	F7149
6	1099	---	Filter Screen	F7150
7	2030	---	Hydro-Timer Swivel, Ball Bearing	F7221
8	1121	---	Mender Sleeve Clip <i>(Not Sold Separately - Available Only in Kits)</i>	
9	1115	3222	Mender Sleeve 5/8" - Vinyl *(Kit - Includes #8 & #10)	F7290 *
10	1116	3222	Mender Sleeve Ferrule 5/8" *(Kit - Includes #8 & #9)	F7290 *
11	1117	3223	Mender Sleeve 1/2" Vinyl *(Kit - Includes #8)	F7291 *
12	1119	3224	Mender Sleeve 1/2" Silicone *(Kit - Includes #8)	F7292 *
13	2015	---	Hose Vinyl 5/8" with 2 Floats	F7146
14	1453	---	Hose Vinyl 1/2" with Sea Anchor	F7179
15	1139	4267	Sea Anchor Kit	F7400 *
16	1814	---	Hose Silicone 1/2" x 2" w/Sea Anchor, Float & Wear Ring	F7200
17	2985	---	Hose Silicone 1/2" x 12" w/2 Wear Rings & Float	F7272
18	2818	---	Pusher Hose Silicone 3/8" ID x 12"	F7264
19	---	4296	Hydro - Timer Replacement Kit	F7401
20	1325	---	Screw #8 x 5/8", Hydro Timer, 2-Pack	V4517
21	2300	---	O-Ring	F7319
22	2822	---	Gear Assembly for Hydro Timer	F7261
23	2029	---	Line Swivel, Ball Bearing - Complete	F7220
24	1140	---	Hose Coupler	F7157
25	1141	---	Line Jet	F7320
26	1162	---	Line Whip "Y" Jet	F7321
27	1161	---	Pusher Jet	F7322
28	3154	---	Whip, 6 Foot, Blue Complete with 8 Wear Rings, Sleeve & Jet	F7285
29	3183	---	Whip, 3 Foot with 3 Wear Rings	F7323
30	1177	---	Whip, 3 Foot, Blue with Wear Rings, Jet & Sleeve	F7324
31	3587	---	Head Complete, Color: White	F7117
32	---	2931	Speed Adjustment Kit	F7270
33	1120	---	Line Float	F7329
34	---	3272	Extension Hose 5/8" w/2 Floats *(Kit - #8 - #10, #13 & #24)	F7298 *
38	2524	---	Hydro-Timer Jet .25	F7331
40	1133	---	Hydro-Timer Case - Top	F7332
41	3781	3981	Hydro-Timer Case - Bottom *(Kit - #20 - #22, & #38 - #40)	F7333 *
42	---	3225	Whip Jet Kit	F7334
43	---	2887	Jandy Filter with Valve and Gauge - Kit	F7140
44	2870	---	Pressure Gauge, 0-60 PSI, 1/8"	F7262
45	2612	---	Jandy Filter Top with Adapter	F7135
46	3391	---	Jandy Cartridge Filter Element	F7138
47	---	3293	Jandy Filter O-Ring Replacement Kit	F7134
48	3191	---	Jandy Filter Bowl with O-Ring	F7133
49	1154	---	Jandy Valve, 3-Port, 1-1/2" CPVC	V4547
50	---	2888	Energy Filter with Gauge *(Kit - Includes #44 thru #48)	F7263 *
51	3786	---	Fitting, 3/4" FGH to Vinyl Hose	F7335
52	---	4047	Swivel Rebuild Kit	F7381
53	---	4060	Quick Disconnect Kit	F7382
56	---	4143	Mender Sleeve Clip Kit (Pack of 6)	F7337
59	1178	---	Barb Joiner	F7338
60	1433	---	Sleeve for Barb Joiner	F7339
61	---	3266	Corner Kit *(Kit - Includes #18, #26, & 40)	F7294 *

JANDY RAY-VAC
Bagged Hose Parts & Kits

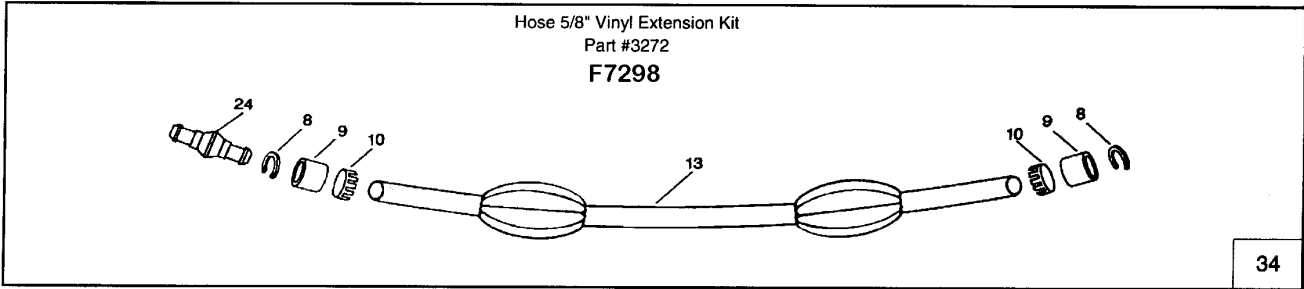

34

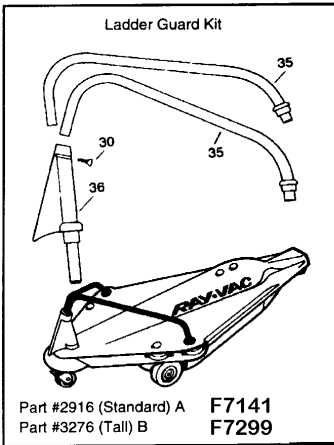

- | | | |
|------|--------------------------------------|-------|
| 7072 | Back Hose Tune-Up Kit (Not Pictured) | F7404 |
| 7073 | Front Hose Tune-Up Kit w/Gear Assy | F7406 |
| 3608 | Complete Hose Replacement | F7327 |

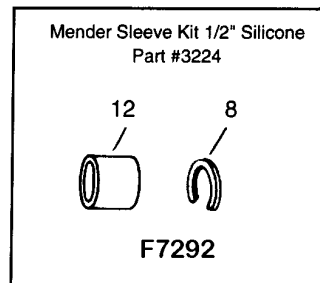
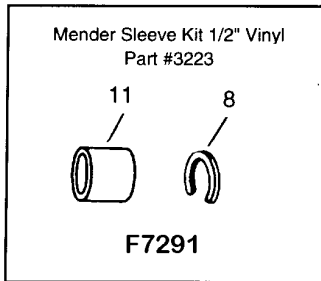
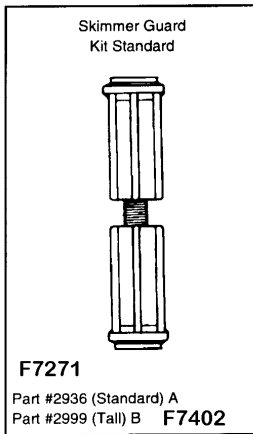
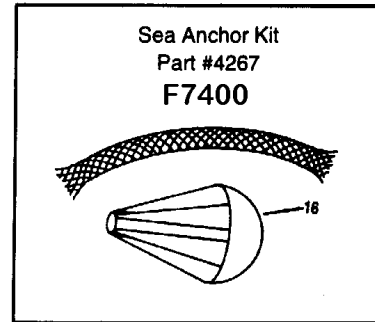
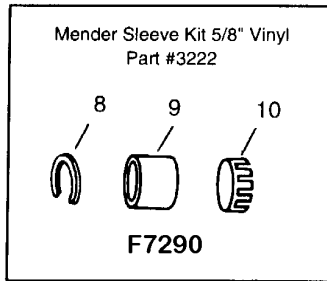

A Teledyne Laars Company

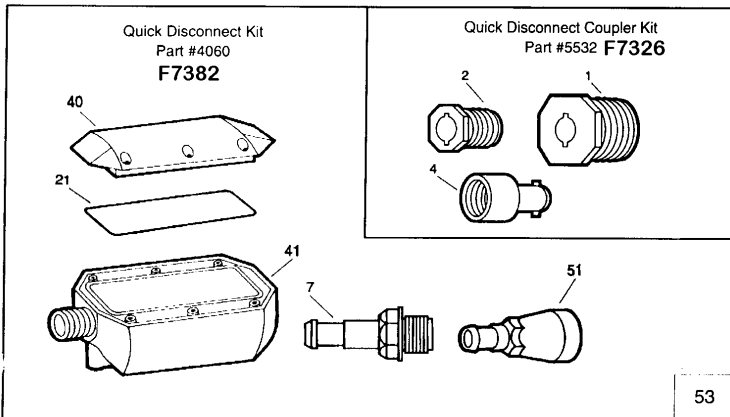

53

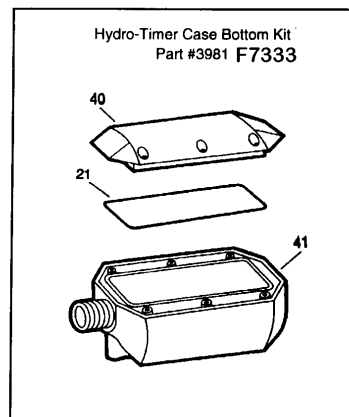

LETRO LEGEND Automatic Pool Cleaner

Complete Product on
page 56

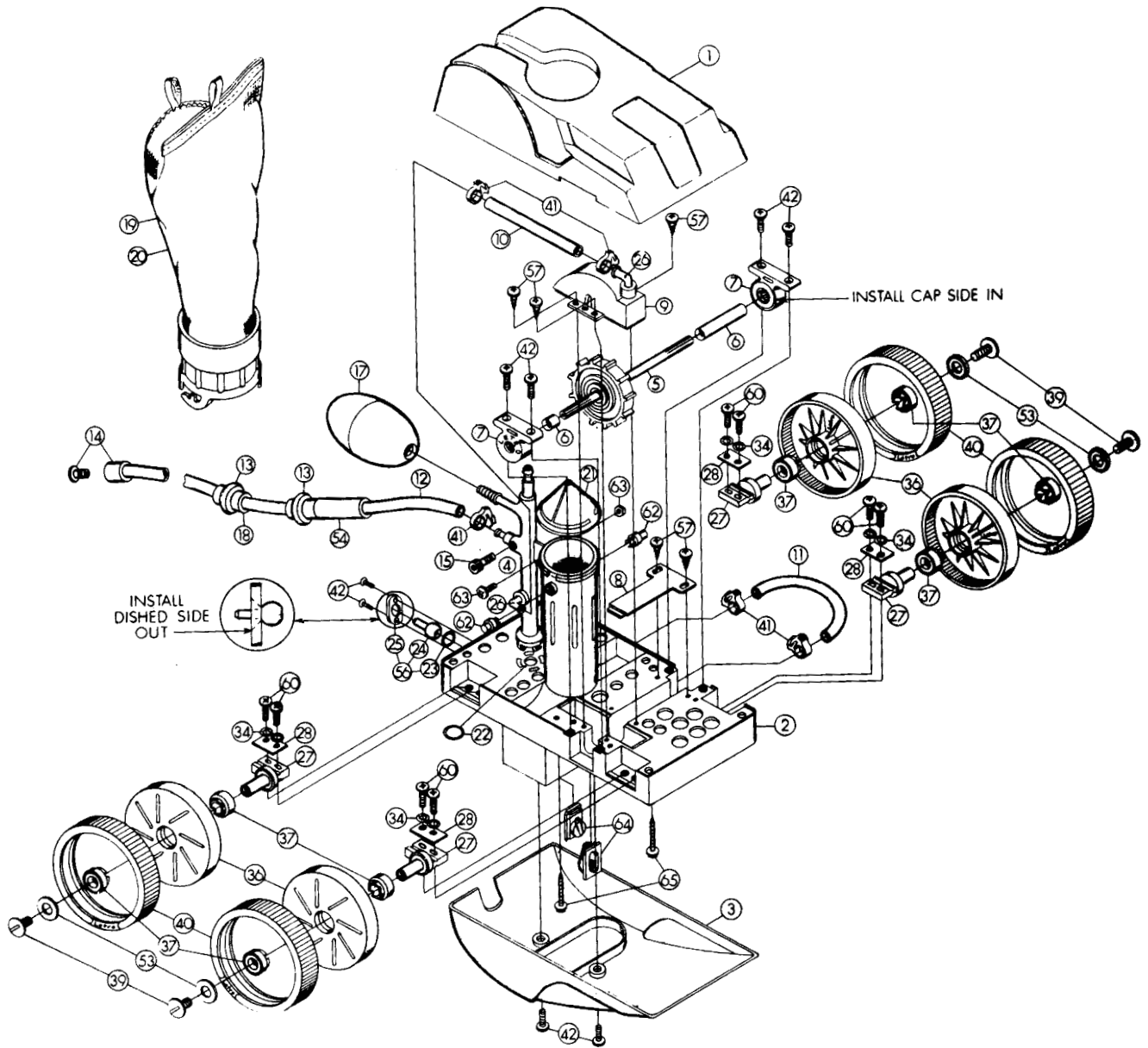

HOSE KIT - # LL209

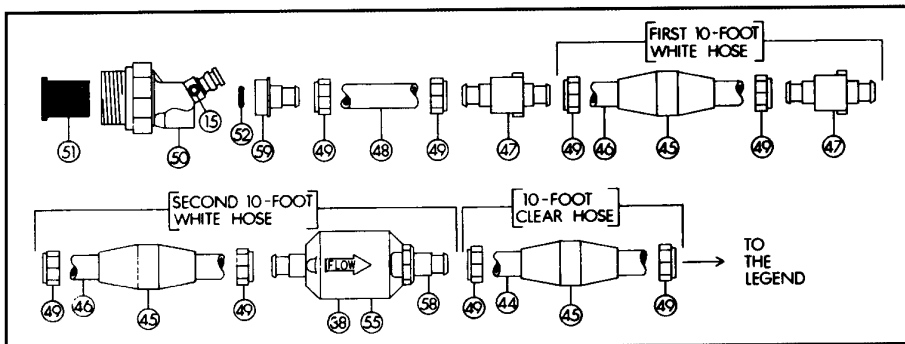

LETRO LEGEND Automatic Pool Cleaner

KEY	MFG NO.	DESCRIPTION	ITEM NO.	KEY	MFG NO.	DESCRIPTION	ITEM NO.
1	LLU5N	Top Cover	E4U05	44	LLD50	Feed Hose Clear Soft	E3D50
2	LLU145N	Main Frame	E4U145*	45	LLD10	Float-Feed Hose	E3D10
3	LLU10N	Bottom Cover	E4U11	46	LLD45	Feed Hose-White	E3D45
4	LLU6	Feed Mast w/O-ring	E4U06	47	LLD20	Swivel-Feed Hose	E3D20
5	LLC86	Turbine Drive Shaft - Complete	E3C86	48	LLU1	Adapter Hose, White, 8 1/2"	E4U01
6	LLC83	Turbine Spacers	E4C83	49	LLD15P	Mendor nut plastic Feed Hose	E3D15
7	LLC80	Turbine Bearings	E3C80	50	LLJVW1A	Wall Fitting w/adj. Screw & Screen	E4183
8	LLA40	Turbine Shaft Shield	E4A40*	51	LLJVW2	Screen Wall Fitting	E4185
9	LLC110	Turbine Cover w/Elbow	E4C110*	52	LLF07	O-ring Wall Fitting	E4043
10	LLC120	Hose for Turbine Cover 7 1/2"	E4C120*	54	LLB2	Weight Sweep Hose	E4B02
11	LLC121	Hose for Venturi Jet	E4C121	55	LLE25	Gears for Back-up Valve	E4E25*
12	LLB5	Sweep Hose Complete	E3B05	56	LLC131	Thrust Jet Repair Kit	E4C131
13	LLB10	Wear Ring-Sweep Hose	E3B10	57	LLA30	Screw for LLA40 & LLC110	E3A30
14	LLB25	Sweep Hose Jet w/ Collar	E3B25	58	LLE16	Swivel for Back-up Valve LLC40-5	E3E16
15	LLB20	Adjustment Screw- Sweep Hose	E4B20	59	LLJ28	Quick Connect- feed hose to wall ftg.	E4088
17	LLA20N	Ballast Float	E3A20	60	LLU76	Bolt, for Axles	E4U76*
18	LLH07	Hose Sleeve-Sweep Hose	E4H07*	62	LLU147	Snap Fit Vac Tube Posts	E4U147
19	LLU16N	Fine Mesh Bag	E4U16	63	LLU79	Nut & Bolt (Feed Mast to Vac Tube)	E4U79*
20	LLU15	Coarse Mesh Bag	E4U15	64	LLU8	Venturi Jet	E4U08*
21a	LLU9	Debris Valve	E4U09	65	LLU80	Hex Screw-Top Cover to Frame	E4U80*
21b	LLU90	O-ring for Vac Tube	E4U90*	---	LL-209	Legend Hose Kit Complete	E4209
22	LLU7	O-ring for Feed Mast	E4U07*	---	LL-206N	Legend Overhaul Kit	E4206*
23	LLC140	O-ring for Thrust Jet	E4058				
24	LLC130	Thrust Jet	E3C130				
25	LLC135	Thrust Jet Plate	E4C135*				
26	LLC115	Elbow for Feed Mast or Turbine Cover	E4C115*				
27	LLC65	Axle-Large Wheels	E3C65				
28	LLC70	Axle Plate for LLC65	E4C70				
34	LLC45	Lock Washer (LLC70)	E3C45				
36	LLC6	Wheel-Large No Bearings	E3C06				
37	LLC60	Bearing for Wheels	E3C60				
38	LLG405	Back-up Valve	E4G40*				
39	LLC55	Wheel Screw, Plastic	E3C55				
40	LLC1	Tire for Large Wheel (4 wheel only)	E4C01				
---	C6LSA	New Tire Design to Climb Problem Areas	E4CLSA*				
41	LLC125	Clamp for Sweep Hose, Turbine & Venturi Jet Hose	E3B15				
42	LLC40	Screw, Bottom Cover Turbine Bearings, Thrust Jet Plate, Swing Axle	E3C40				

*Non-Stock

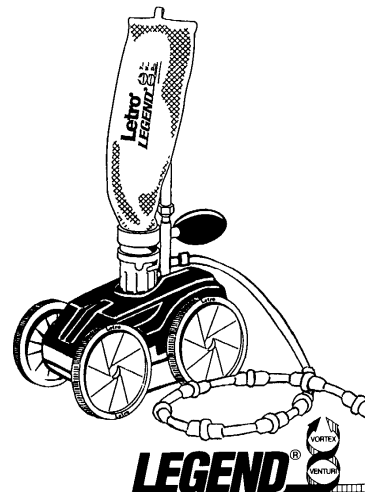

LETRO LEGEND II
(No Booster Pump Required)

Complete Product on
page 56

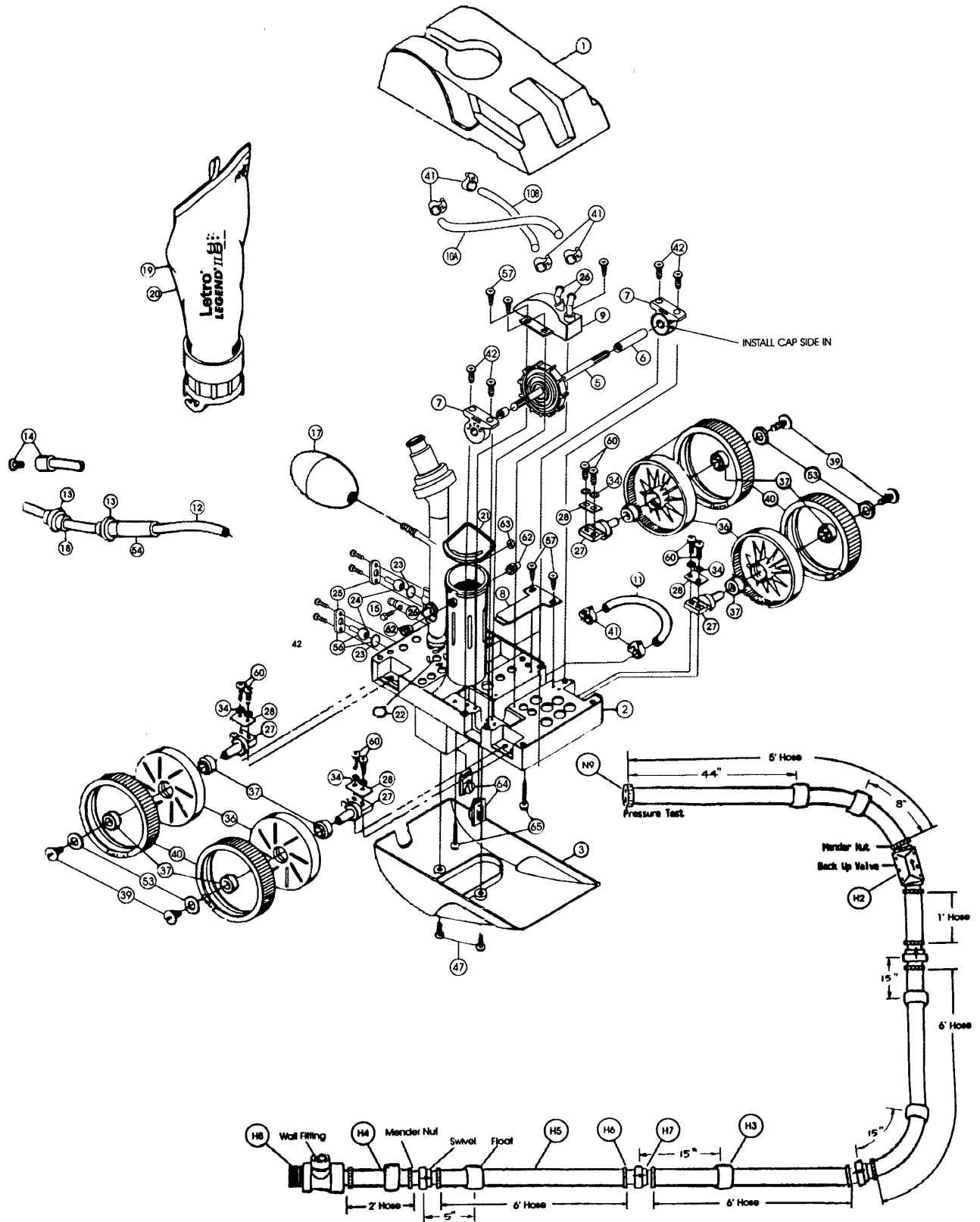

LETRO LEGEND II

KEY	MFG. NO.	DESCRIPTION	ITEM NO.	KEY	MFG. NO.	DESCRIPTION	ITEM NO.
---	LX2000	Legend II Complete	E4195	47	LXU80	Hex Screw Cover to	
---	LX209	Legend Hose Box	E4197			Frame, 2 pack(2 needed)	E4LXU80
1	LXU5	Top Cover (white, gray, burgundy, black)	E4LXU5	53	LXC64	Wheel Washer, 5 pack (4 needed)	E4LXC64
2	LXU145N	Main Frame	E4145N	54	LXB2	Weight - Sweep Hose	E4LXB2
3	LXU10N	Bottom Cover w/ Bracket	E4XU10N	57	LXA30	Screw for 8 & 9, 5 pack (5 needed)	E4LXA30
4	LXU6	Feed Mast w/ O-Ring & Swivel	E4LXU6	60	LXU76	Bolt for Axles, 2 pack (8 needed)	E4LXU76
5	LXC86	Turbine Drive Shaft - Assd	E4LXC86	62	LXU147	Snap Fit Vac Tube Post, 2 pack	E4LXU147
6	LXC83	Turbine Spacer	E4LXC83	---	LXU77	Bolt for LXU6 Feed Mast, Vac Tube	E4LXU77
7	LXC80	Turbine Bearing(2 needed)	E4LXC80	---	LXU78	Nut for Feed Mast, Vac Tube	E4LXU78
8	LXA40	Turbine Shaft Shield	E4LXA40	63	LXU79	Nut & Bolt - Feed Mast to Vac Tube	E4LXU79
9	LXC110	Turbine Cover w/ Elbow	E4LXC110	64	LXU8	Venturi Jet, 2 pack (2 needed)	E4LXU8
10A	LXC120	Hose for LXC110- 9" long	E4LXC120	H2	LX10	Back-up Valve - Legend II	E4LX10
10B	LL120	Turbine Cover Hose 7"	E4LL120	---	LX11	Housing Body - B/U Valve	E4LX11
11	LXC121	Venturi Jet - Hose	E4LXC121	---	LX12	Housing Top Cover - B/U Valve	E4LX12
12	LXB5	Sweep Hose - Complete	E4LXB5	---	LX13	O-Ring for Housing Body #0250	E4LX13
13	LXB10	Wear Ring, 5 pack (9 needed)	E4LXB10	---	LX14	O-Ring - Gear Assy. #0251	E4LX14
14	LXB25	Sweep Hose Jet w/ Collar	E4LXB25	---	LX15	Screw for Housing Body, 6 pack	E4LX15
15	LXB20	Adjustment Screw for Sweep Hose , 2 pack	E4LXB20	---	LX16	Gear Assy. - B/U Valve	E4LX16
17	LXA20	Ballast Float	E4LXA20	H3	LXD10	Float for Legend II - Feed Line (7 needed)	E4LXD10
18	LXH07	Hose Sleeve, 4 pack (17 needed)	E4LXH07	H4	LX18	Hose - 2', 1st Section	E4LX18
19	LXU15	Coarse Mesh Bag	E4LXU15	H5	LX17	Hose - 6' (4 needed)	E4LX17
20	LXU16	Fine Mesh Bag	E4LXU16	H6	LX20	Hose Mender w/ O-Ring #0252, 2 pk (12 needed)	E4LX20
21	LXU9	Debris Valve	E4LXU9	---	LX21	O-Ring #0252 for Wall Fitting & Hose Mender	E4LX21
22	LXU7	O-Ring for Feed Mast	E4LXU7	H7	LX19	Swivel - Complete (4 needed)	E4LX19
---	LXC131	Thrust Jet Repair Kit (See 23, 24, 25)	E4LXC131	H8	LXW22	Wall Fitting - Complete	E4LXW22
23	LXC140	O-Ring for Thrust Jet (2 needed)	E4LXC140	---	LX23	Wall Fitting Quick Disconnect Adapter	E4LX23
24	LXC130	Thrust Jet (2 needed)	E4LXC130	---	LX24	Screen for Wall Fitting	E4LX24
25	LXC135	Thrust Jet Plate(2 needed)	E4LXC135	---	LX25	Pressure Relief Valve for Wall Fitting	E4LX25
26	LXC115	Elbow for Feed Mast / Turbine Cover (2 needed)	E4LXC115	H9	LX26	Pressure Tester	E4LX26
27	LXC65	Axle - Large (Rear)(4 needed)	E4LXC65	---	LXU13	Step Adapter	E4LXU13
28	LXC70	Axle Plate, 2 pack (4 needed)	E4LXC70				
34	LXC45	Lock Washer for LXC70, 5 pack (8 needed)	E4LXC45				
36	LXC6	Wheel - Large(4 needed)	E4LXC6				
37	LXC60	Ball Bearing, 2 pack (8 needed)	E4LXC60				
39	LXC55	Wheel Screw, 5 pack (4 needed)	E4LXC55				
40	LXC1	Tire for Legend II (4 needed)	E4LXC1				
---	LXC10BK	Tire for Large Wheel	E4LXC10				
41	LXC125	Hose Clamp, 2 pack (7 needed)	E4LXC125				
42,49	LXC40	Screw for Bottom Cover, Turbine, Bearings, Thrust Jet Plate, 10 pack (10 needed)	E4LXC40				

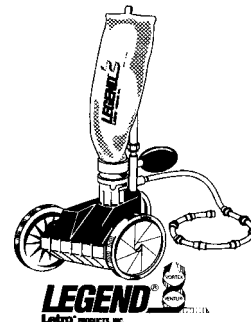

LETRO LEGEND 3 Wheel Model Automatic Pool Cleaner

Complete Product on
page 56

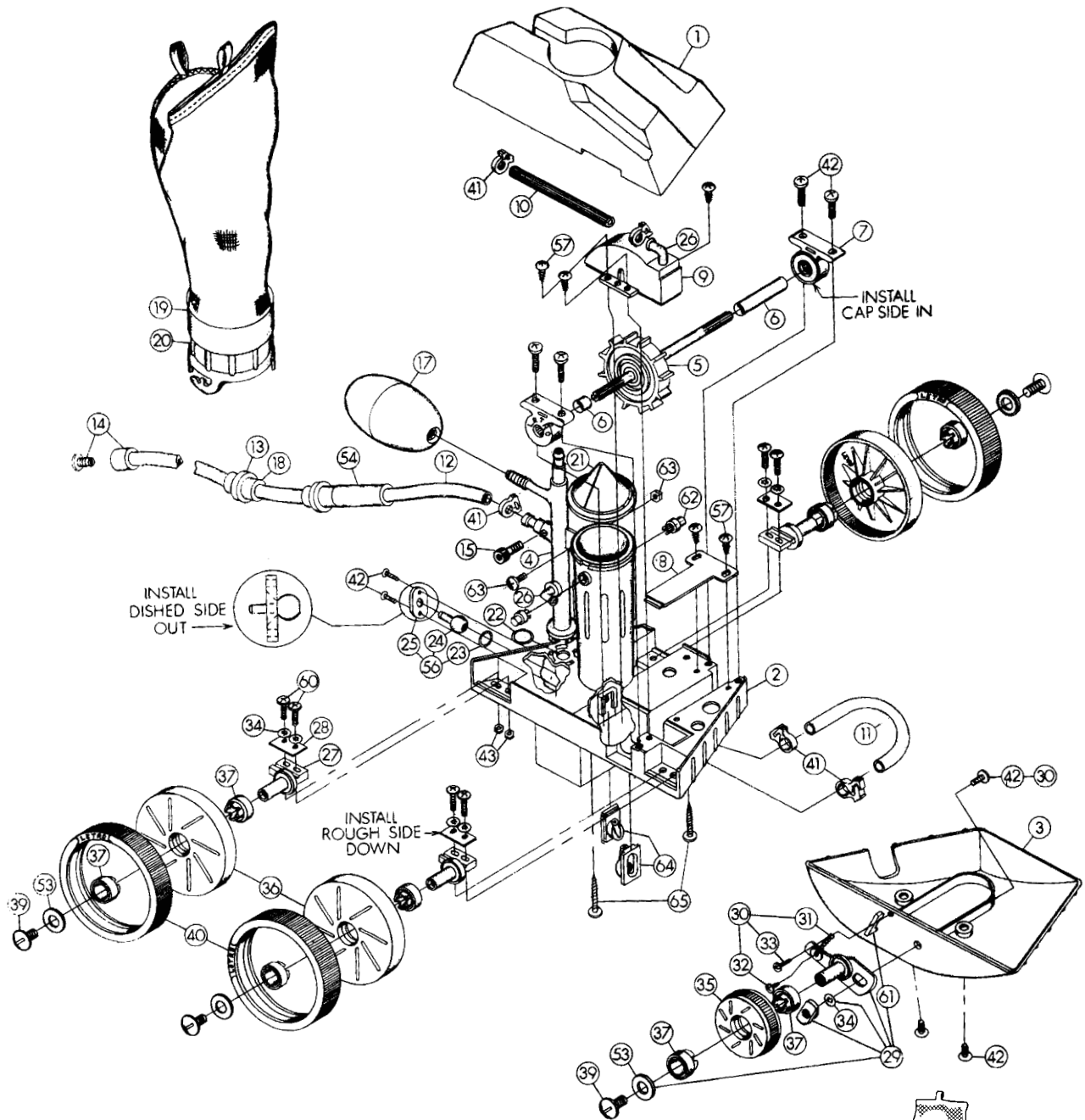

HOSE KIT - # LL209

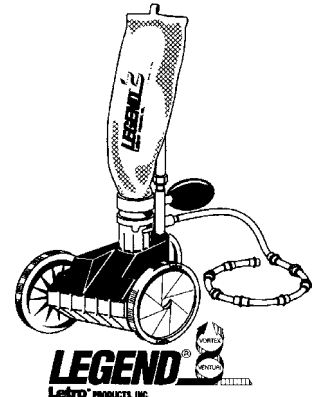
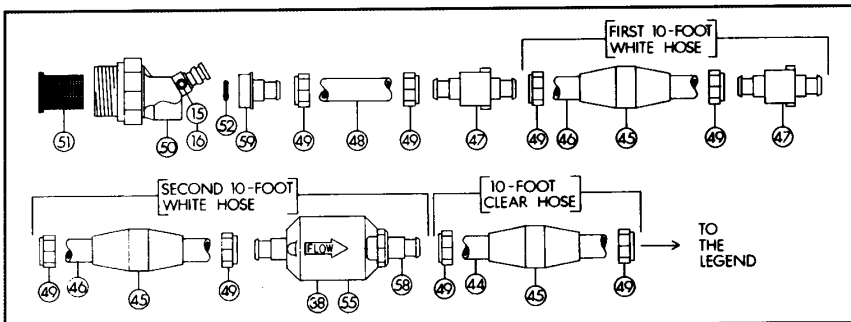

LETRO LEGEND 3 Wheel Model
Automatic Pool Cleaner

KEY	MFG NO.	DESCRIPTION	ITEM NO.	KEY	MFG NO.	DESCRIPTION	ITEM NO.
1	LLU5	Top Cover	E4U05	37	LLC60	Bearing for Wheels	E4C60
2	LLU145	Main Frame	E4N145	38	LLG405	Back-up Valve E4G40	
3	LLU10	Bottom Cover w/Bracket	E4U10	39	LLC55	Wheel Screw-Plastic	E4C55
4	LLU6	Feed Mast w/O-ring	E4U06	40	LLC10	Tire for Large Wheel	E4C10
5	LLC86	Turbine Drive Shaft Complete	E4C86	41	LLC125	Clamp for Sweep Hose, Turbine Bearings,Thrust Jet Plate, Swing Axle	E4C125
6	LLC83	Turbine Spacers	E4C83	42	LLC40	Screw for Bottom Cover, Turbine Bearings, Thrust Jet Plate, Swing Axle	E4C40
7	LLC80	Turbine Bearings	E4C80				
8	LLA40	Turbine Shaft Shield	E4A40				
9	LLC110	Turbine Cover w/Elbow	E4C110				
10	LLC120	Hose for Turbine Cover 7 1/2"	E4C120	43	LLC75	Nut, Rear Axle Only	E4C75
11	LLC121	Hose for Venturi Jet	E4C121	44	LLD50	Feed Hose-Clear, Soft-10'	E4D50
12	LLB5	Sweep Hose Complete	E4B05	45	LLD10	Float-Feed Hose	E4D10
13	LLB10	Wear Ring-Sweep Hose	E4B10	46	LLD45	Feed Hose, White 10'	E4D45
14	LLB25	Sweep Hose Jet w/ Collar	E4B25	47	LLD20	Swivel-Feed Hose	E4D20
15	LLB20	Adjustment Screw - Sweep Hose	E4B20	48	LLU1	Adapter Hose, White, 8-1/2"	E4U01
17	LLA20	Ballast Float	E4A20	49	LLD15	Mender Nut, Plastic, Feed Hose	E4D15
18	LLH07	Hose Sleeve - Sweep Hose	E4H07	50	LLJVW1A	Wall Fitting w/ Adj. Screw & Screen	E4183
19	LLU16	Fine Mesh Bag	E4U16	51	LLJVW2	Screen, Wall Fitting	E4185
20	LLU15	Coarse Mesh Bag	E4U15	52	LLF07	O-ring, Wall Fitting	E4F07
21	LLU9	Debris Valve	E4U09	53	LLC64	Washer-Wheels, Plastic	E4C64
22	LLU7	O-ring for Feed Mast	E4U07	54	LLB2	Weight-Sweep Hose	E4B02
23	LLC140	O-ring for Thrust Jet	E4C140	55	LLE25	Gears for Back-up Valve	E4E25
24	LLC130	Thrust Jet	E4C130	56	LLC131	Thrust Jet Repair Kit (includes LLC130, LLC153, LLC140)	E4C131
25	LLC135	Thrust Jet Plate	E4C135	57	LLA30	Screw for LLA40 & LLC110	E4A30
26	LLC115	Elbow for Feed Mast or Turbine Cover	E4C115	58	LLE16	Swivel for Back-up Valve LLC405	E4E16
27	LLC65	Axle-Large Wheels	E4C65	59	LLJ28	Quick Connect-Feed Hose to Wall Fitting	E4J28
28	LLC70	Axle Plate for LLC65	E4C70	60	LLU76	Bolt-for Axles	E4U76
29	LLC36	Swing Axle w/ Tee, Washer & Bracket	E4C36	61	LLC36	Snap Fit Bracket	E4C36
30	LLC36H	Swing Axle Hardware Kit	E4C36H	62	LLU147	Snap Fit Vac Tube Posts	E4U147
31	LLC25	Spring-Swing Axle	E4C25	63	LLU79	Nut & Bolt (Feed Mast to Vac Tube)	E4U79
32	LLC30	Screw for Spring to Swing Axle	E4C30	64	LLU8	Venturi Jet	E4U08
33	LLC32	Screw for Spring to Bottom Cover	E4C32	65	LLU80	Hex Screw-Top Cover to Frame	E4U80
34	LLC45	Lock Washer for LLC36, LLC70	E4C45	---	LL205	Legend Tune up Kit (3 Wheel)	E4190
35	LLC16	Wheel-Small for Swing Axle	E4C16				
36	LLC6	Wheel-Large (no bearings)	E4C06				

Complete Product on
page 60

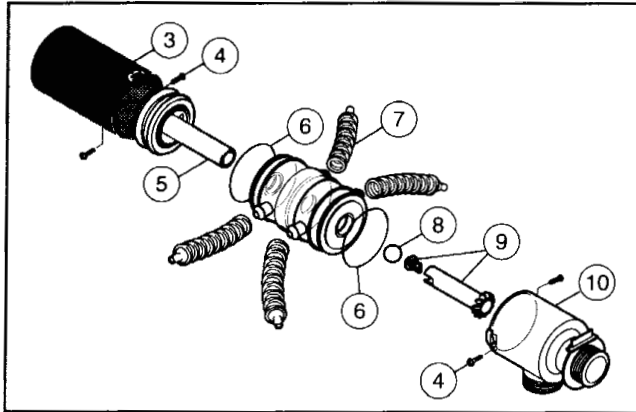

 **Polaris65**

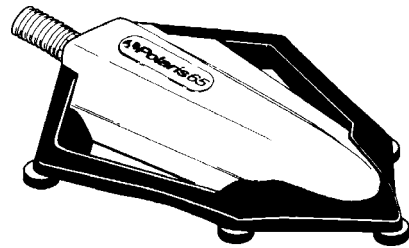
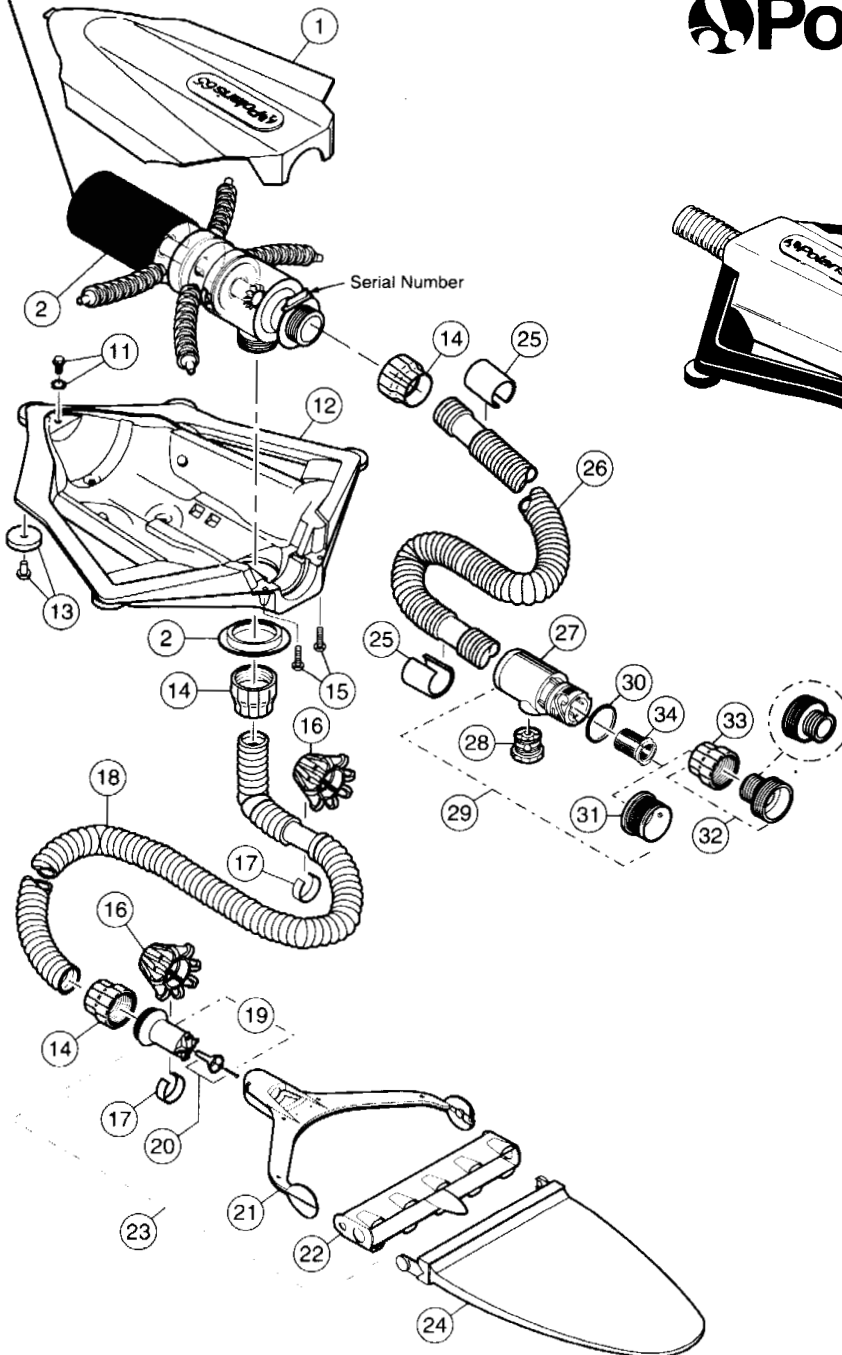

POLARIS 65
Non-booster Pump Cleaner

KEY	MFG NO.	DESCRIPTION	ITEM NO.
1	6-304-00	Surface Module Top	E2590
2	6-400-00	Mechanism	E2579
3	6-407-00	Cylinder	E2652
4	6-413-00	Screw, Mechanism, #6 x 5/16", SS	E2504
5	6-411-00	Piston Assembly	E2555
6	6-412-00	O-Ring, Chamber Assembly	E2585
7	6-410-00	Jet Nozzle Hose Assembly	E2604
8	6-403-00	Randomizer Ball	E2501
9	6-406-00	Filter Connector/Randomizer Tube Kit	E2581
10	6-408-00	Connector Chamber	E2609
11	6-507-00	Drain Plug Assembly	E2591
12	6-303-00	Body Bottom Assembly	E2569
13	6-300-00	Body Bottom Wheel Kit	E2594
14	6-104-00	Hose Connector, Female	E2596
15	6-302-00	Screw, Top, #10 x 3/4" SS, Pan Hd	E2595
16	6-107-00	Wheel Cage Assembly	E2558
17	6-110-00	Hose Weight	E2553
18	6-106-00	Sweep Hose Complete, 7 Feet	E2556
19	6-116-00	Jet Body Assembly	E2659
20	6-119-00	Jet Body Ball Kit	E2660
21	6-211-00	Jet Sweep Harness	E2661
22	6-210-00	Jet Sweep Head	E2662
23	6-212-00	Jet Sweep Assembly	E2565
24	6-206-00	Sand/Silt Bag	E2509
25	6-102-00	Float	E2593
26	6-115-00	Float Hose, 24 Feet (hose only)	E2599
27	6-502-00	Quick Disconnect, UFW	E2663
28	6-503-00	Pressure Relief Valve, Blue	E2664
29	6-508-00	UWF Connector Assembly	E2580
30	6-505-00	O-Ring, UFW/QD	E2573
31	6-500-00	Universal Wall Fitting (UFW)	E2524
32	6-510-00	UWF Adapter, 1 1/4" or 2"	E2502
33	6-512-00	UFW Adapter, 2"	E2619
34	6-504-00	Filter Screen, UFW/QD	E2578
—	6-101-00	Adapter Kit for 1 1/4" or 2" (60)	E2597
—	6-103-00	Hose Connector, Male	E2592
—	6-108-00	Jet Body Assembly (160/60)	E2554
—	6-109-00	Hanger Kit (includes 8 brackets)	E2557
—	6-111-00	Float Hose Extension Kit, 8 Feet	E2552
—	6-112-00	Sweep Hose, 10 Feet (hose only)	E2598
—	6-113-00	In-Line Pressure Tester	E2550
—	6-118-00	Jet Body Ball Kit (160/60)	E2666
—	6-204-00	Filter Bag, Snap (160/60)	E2567
—	6-205-00	Leaf Bag, Snap (160/60)	E2535
—	6-207-00	Leaf Bag	E2506
—	6-509-00	Gorilla Jet Adapter	E2623
—	6-511-00	UWF Eyeball Fitting	E2505
—	6-700-00	165/65 Conversion Kit	E2668
—	9-100-8006	Standard Eyeball Regulator Disk	E2665
—	10-102-00	UWF Removal Tool, Plastic	E2525
—	10-104-00	UWF Removal Tool, SS	E2670
—	11-203-00	Adjustable Plug, UWF	E2526

Complete Product on page 60

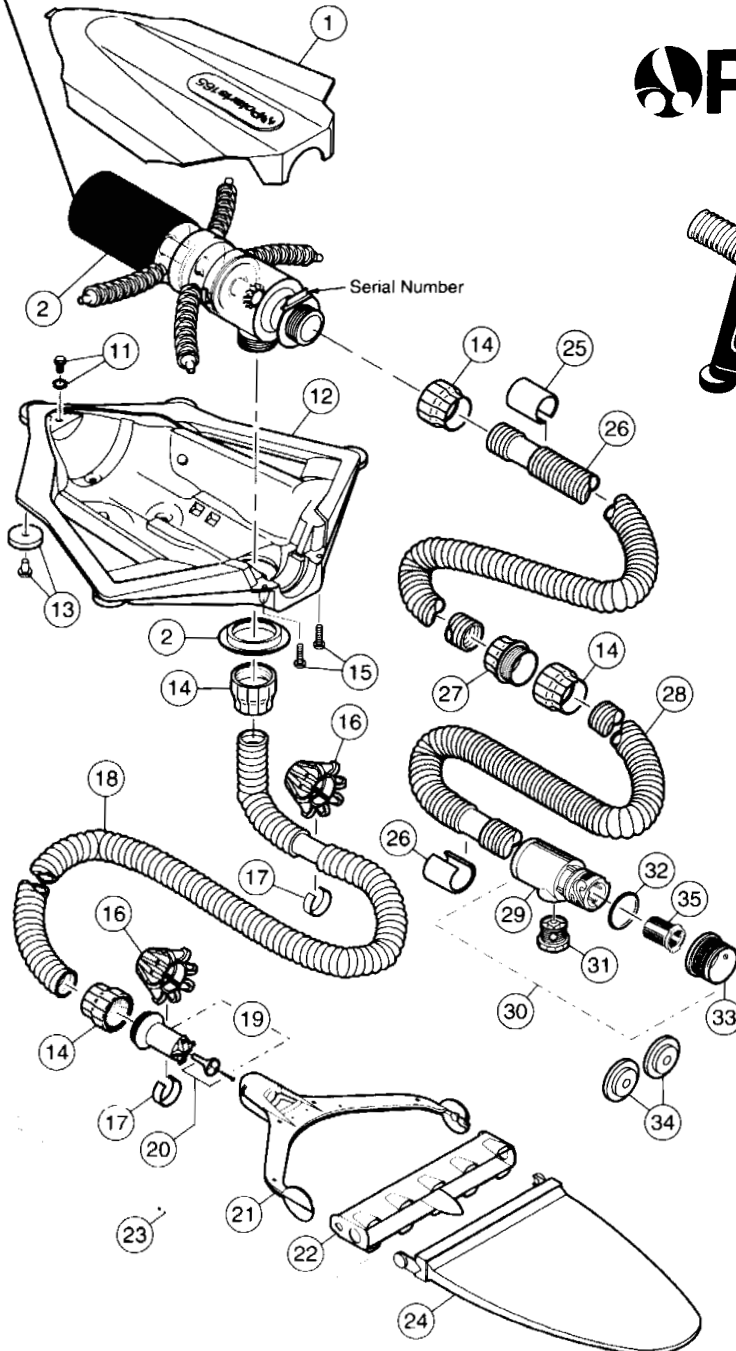
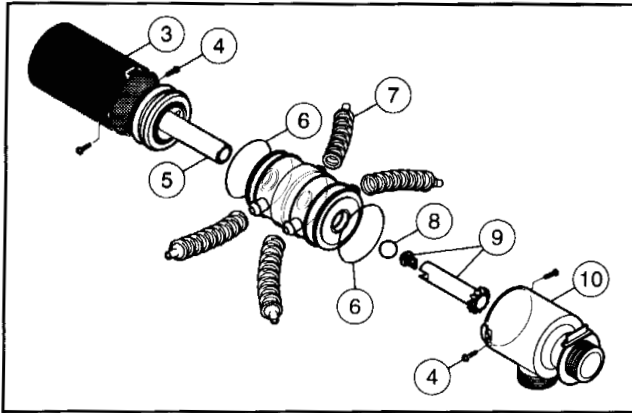

 **Polaris165**

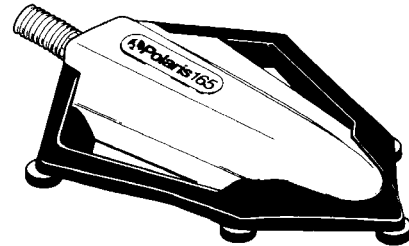

POLARIS 165
Non-booster Pump Cleaner

KEY	MFG NO.	DESCRIPTION	ITEM NO.
—	6-120-00	Polaris 165 Complete	E2050
1	6-306-00	Surface Module Top	E2651
2	6-400-00	Mechanism	E2579
3	6-407-00	Cylinder	E2652
4	6-413-00	Screw, Mechanism, #6 x 5/16" SS	E2504
5	6-411-00	Piston Assembly	E2555
6	6-412-00	O-Ring, Chamber Assembly	E2585
7	6-410-00	Jet Nozzle Hose Assembly	E2604
8	6-403-00	Randomizer Ball	E2501
9	6-406-00	Filter Connector/Randomizer Tube Kit	E2581
10	6-408-00	Connector Chamber	E2609
11	6-507-00	Drain Plug Assembly	E2591
12	6-303-00	Body Bottom Assembly	E2569
13	6-300-00	Body Bottom Wheel Kit	E2594
14	6-104-00	Hose Connector, Female	E2596
15	6-302-00	Screw, Top, # 10 x 3/4" SS, Pan Hd	E2595
16	6-107-00	Wheel Cage Assembly	E2558
17	6-110-00	Hose Weight	E2553
18	6-114-00	Sweep Hose Complete, 10 Ft.	E2658
19	6-116-00	Jet Body Assembly	E2659
20	6-119-00	Jet Body Ball Kit	E2660
21	6-211-00	Jet Sweep Harness	E2661
22	6-210-00	Jet Sweep Head	E2662
23	6-212-00	Jet Sweep Assembly	E2565
24	6-206-00	Sand/Silt Bag	E2509
25	6-102-00	Float	E2593
26	6-111-00	Float Hose Extension Kit, 8 Ft.	E2552
27	6-103-00	Hose Connector, Male	E2592
28	6-115-00	Float Hose, 24 Ft. (hose only)	E2599
29	6-502-00	Quick Disconnect, UWF	E2663
30	6-508-00	UWF Connector Assembly	E2580
31	6-503-00	Pressure Relief Valve, Blue	E2664
32	6-505-00	O-Ring, UWF/QD	E2573
33	6-500-00	Universal Wall Fitting (UWF)	E2524
34	9-100-8006	Standard Eyeball Regulator Disk	E2665
35	6-504-00	Filter Screen, UWF/QD	E2578
—	6-108-00	Jet Body Assembly (160/60)	E2554
—	6-109-00	Hanger Kit (includes 8 brackets)	E2557
—	6-112-00	Sweep Hose, 10 Ft. (hose only)	E2598
—	6-113-00	In-Line Pressure Tester	E2550
—	6-118-00	Jet Body Ball Kit (160/60)	E2666
—	6-204-00	Filter Bag, Snap (160/60)	E2567
—	6-205-00	Leaf Bag, Snap (160/60)	E2535
—	6-207-00	Leaf Bag	E2506
—	6-511-00	UWF Eyeball Fitting	E2667
—	6-700-00	165/65 Conversion Kit	E2668
—	9-100-8021	Vinyl Eyeball Kit	E2672
—	10-102-00	UWF Removal Tool, Plastic	E2525
—	10-104-00	UWF Removal Tool, Stainless Steel	E2670
—	10-107-00	Eyeball Regulator	E2671
—	11-203-00	Adjustable Plug, UWF	E2526

Polaris180

Booster Pump Cleaner

Complete Product on page 60

Cleaning Equipment

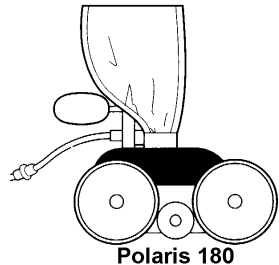
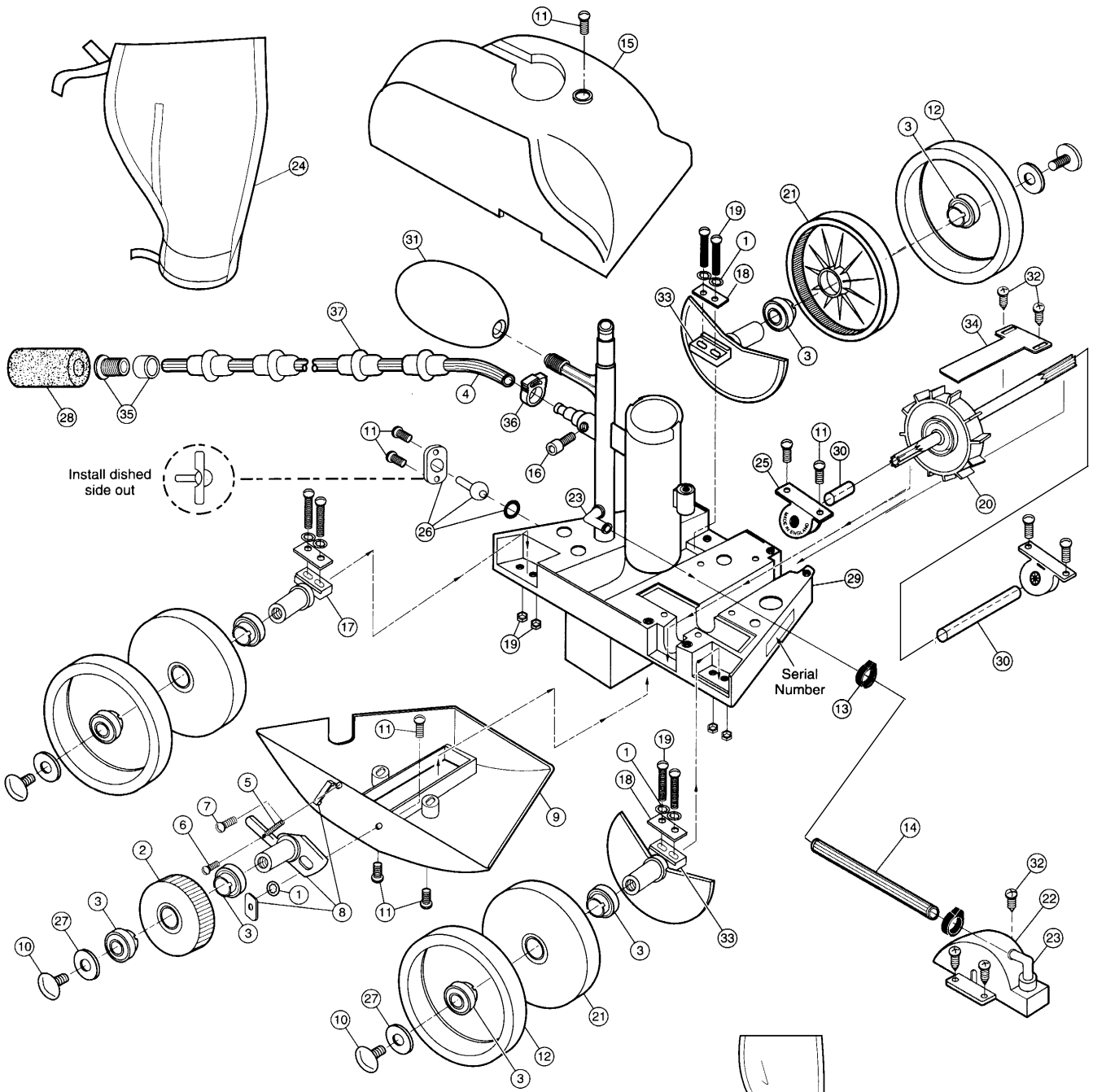

Polaris 180

POLARIS 180 VAC-SWEEP
Booster Pump Cleaner

KEY	MFG NO.	DESCRIPTION	ITEM NO.
--	F-20	Polaris 180 Head/Hose	E2001
1	C-45	Lock Washer for C-36	E2C45
2	C-16	Idler Wheel, White	E2C16
3	C-60	Ball Bearings, Wheels	E2C60
4	B-5	Sweep Hose Complete	E2B05
5	C-25	Spring for C-36	E2C25
6	C-30	Screw, 4-40 x 3/16" SS Pan Hd	E2C30
7	C-32	Screw, 6-32 x 1/2" SS Pan Hd	E2C32
8	C-36	Swing Axle Kit	E2C36
9	A-10	Bottom, White with Bracket	E2A10
10	C-55	Wheel Screw, Plastic	E2C55
11	C-40	Screw, 10-32 x 3/8" SS Pan Hd	E2C40
12	C-10	Tire, White	E2C10
13	9-100-7170	Hose Clamp	E2570
14	C-120	Hose for C-110, 7 1/2"	E2C81
15	A-5	Top, Blue	E2A05
16	B-20	Adjustment Screw, Sweep Hose	E2B20
17	C-65	Axle, Large (rear wheel only)	E2C65
18	C-70	Axle Plate for C-65/C-66	E2C70
19	C-75	Screw/Nut, 10-32 x 7/8" SS Pan Hd	E2C75
20	C-86	Drive Shaft Assembly	E2C86
21	C-6	Wheel, Large (no bearings included)	E2C06
22	C-110	Turbine Cover with Elbow	E2C97
23	C-115	Elbow for C-110 or Feed Mast	E2C98
24	A-16	Sand/Silt Bag, Reusable	E2A16
25	C-80	Ball Bearings, Turbine	E2C80
26	C-131	Thrust Jet Kit	E2C31
27	C-64	Wheel Washer, Plastic	E2C64
28	9-100-3105	Sweep Hose Scrubber	E2514
29	C-145	Frame, Exchange Only	E2C04
30	C-83	Turbine Shaft Tubes	E2C83
31	A-20	Float, Head	E2A20
32	A-30	Screw, # 10 x 1/2" SS Pan Hd, Self-tap	E2A30
33	C-66	Axle, Large (with sand/gravel guard)	E2C66
34	A-40	Turbine Shaft Shield	E2A40
35	B-25	Orifice Tip w/ Orifice Tip Guard	E2B25
36	B-15	Sweep Hose Attach Clamp	E2B15
37	B-10	Wear Rings	E2B10

POLARIS 180 VAC-SWEEP (Cont.) Hose Assemblies & Back-up Valve

KEY	MFG. NO.	DESCRIPTION	ITEM NO.
38	9-100-9001	UWF Connector Assy (Replaces D-27)	E2522
39	10-108-00	UWF Restrictor Kit	E2602
40	6-500-00	Universal Wall Fitting (UWF)	E2524
41	6-504-00	Filter Screen, UWF/QD	E2578
42	6-505-00	O-Ring, UWF/QD	E2573
43	9-100-9002	Pressure Relief Valve (Replaces D-28)	E2564
44	D-29	Quick Disconnect, UWF	E2D29
45	D-15	Nut, Feed Hose	E2D15
47	D-20	Swivel, Ball Bearing	E2D20
48	D-10	Float, Feed Hose	E2D10
49	D-45	Feed Hose - White, 10 Ft, Hard	E2D45
50	D-50	Feed Hose - Clear, 10 Ft., Hard	E2D50
51	G-52	Back-up Valve Kit (Replaces G-41)	E2G52
52	G-54	Case Kit for G-52	E2G54
53	G-53	Mechanism for G-52	E2G53
---	G-56	Back-up Booster Valve Seat (Increases power of G-52 Valve)	E2G56

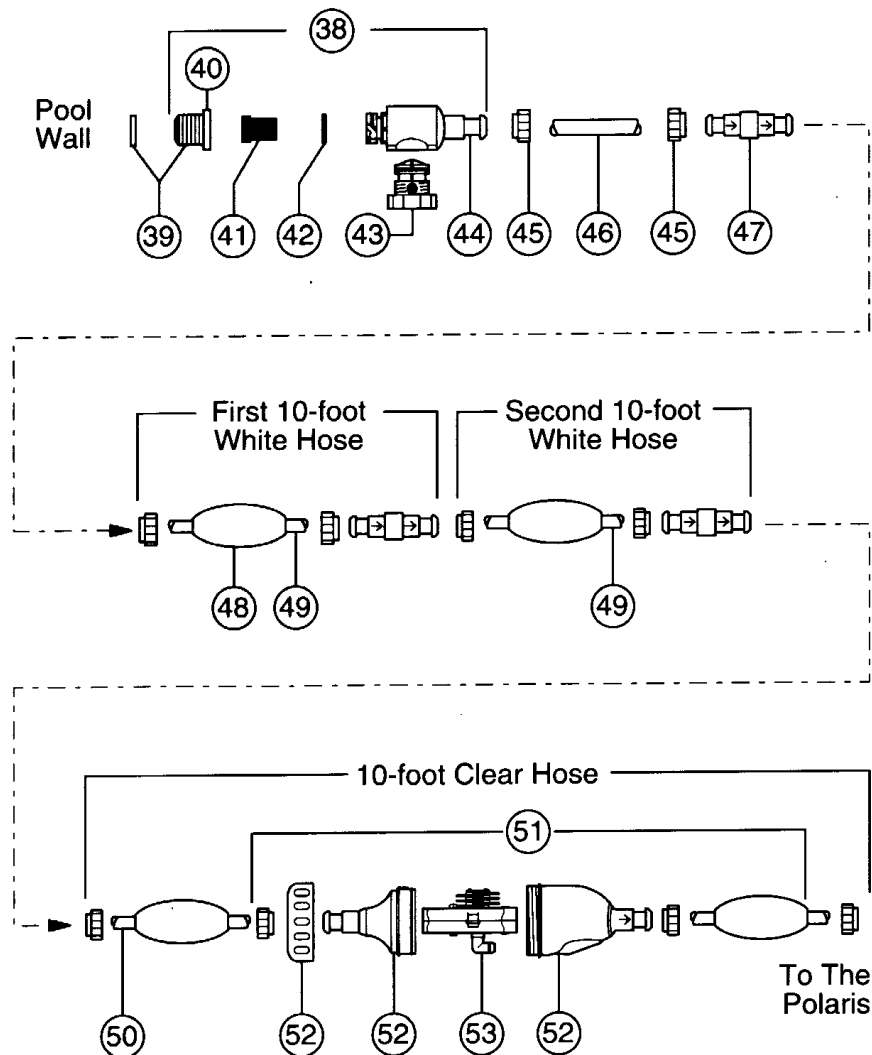

POLARIS 180 VAC-SWEEP (Cont.)
Old Style Quick Disconnect, Pre-1991

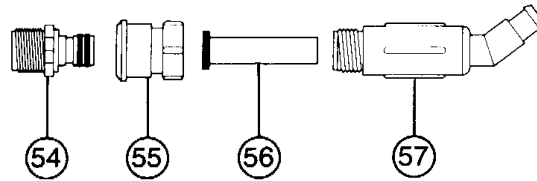

KEY	MFG NO.	DESCRIPTION	ITEM NO.
54	D-23	Quick Disconnect Plug w/2 O-Rings	E2D23
55	D-26	Quick Disconnect, Female, Plastic	E2D26
56	D-36	Strainer, Tube Type	E2D36
57	D-31	Hose Barb/Strainer Housing, Clear Plastic	E2D31

Parts Not Shown

KEY	MFG. NO.	DESCRIPTION	ITEM NO.
---	A-15	Leaf Bag	E2A15
---	A-42	Sweep Hose Barb Repair Kit	E2A42
---	A-45	Float Arm Repair Kit	E2A45
---	A-47	Polaris 180 Factory Rebuild Kit	E2A47
---	A-49	Polaris 280/180 Factory Tune-up Kit	E2A49
---	B-2	Weight, Sweep Hose	E2B02
---	C-11	Tire, Black	E2C11
---	C-12	Tire, Krayton	E2C12
---	C-63	Axle, Shim	E2C63
---	C-125	Clamp for C-120, Black	E2C82
---	D-22	Quick Disconnect Plug, NHTM, w/2 O-Rings	E2D22
---	D-24	O-Ring for D-22/D-23	E2D24
---	D-32	Collar, Wall Fitting	E2D32
---	E-60	Mechanism for G-41	E2E60
---	E-65	Case Kit, Back Up Valve for G-41	E2E65
---	G-5	Feed Hose Complete, No Back-Up Valve	E2G05
---	G-9	Coupling, 1 1/2" NPTF x 3/4" NPTM	E2G09
---	G-12	Over-the-Deck Kit, UWF, 1991	E2G12
---	G-21	Ladder Guard Set, 2 Panels	E2G21
---	G-35	Pressure Tester w/o Gauge	E2G35
---	G-45	Sand/Silt Bags, Pkg. 4, Disposable	E2G45
---	G-55	Pressure Restrict, 12lb. Red & 6lb. Blue	E2G55
---	G-110	Wet Function Bench Test	E2G70
---	G-118	Over Deck Mount	E2G71
---	P-133	Softube (TM) Quick Connect	E2P133
---	P-135	Pump Hose Spool, 25 Ft., Flexible Reinforced	E2P135
---	6-550-00	UWF, Black	E2507
---	9-100-3104	Feed Hose with Floats, White	E2606
---	9-100-3108	Feed Hose with Floats, Clear	E2607
---	9-100-5117	Screw, 8-32 x 3/8" SS Pan Hd	E2543
---	9-100-9003	Street Ell	E2603
---	10-102-00	UWF Removal Tool, Plastic	E2525
---	10-104-00	UWF Removal Tool, Stainless Steel	E2670
---	11-203-00	Adjustable Plug, UWF	E2526

Polaris280

Booster Pump Cleaner

Complete Product on page 60

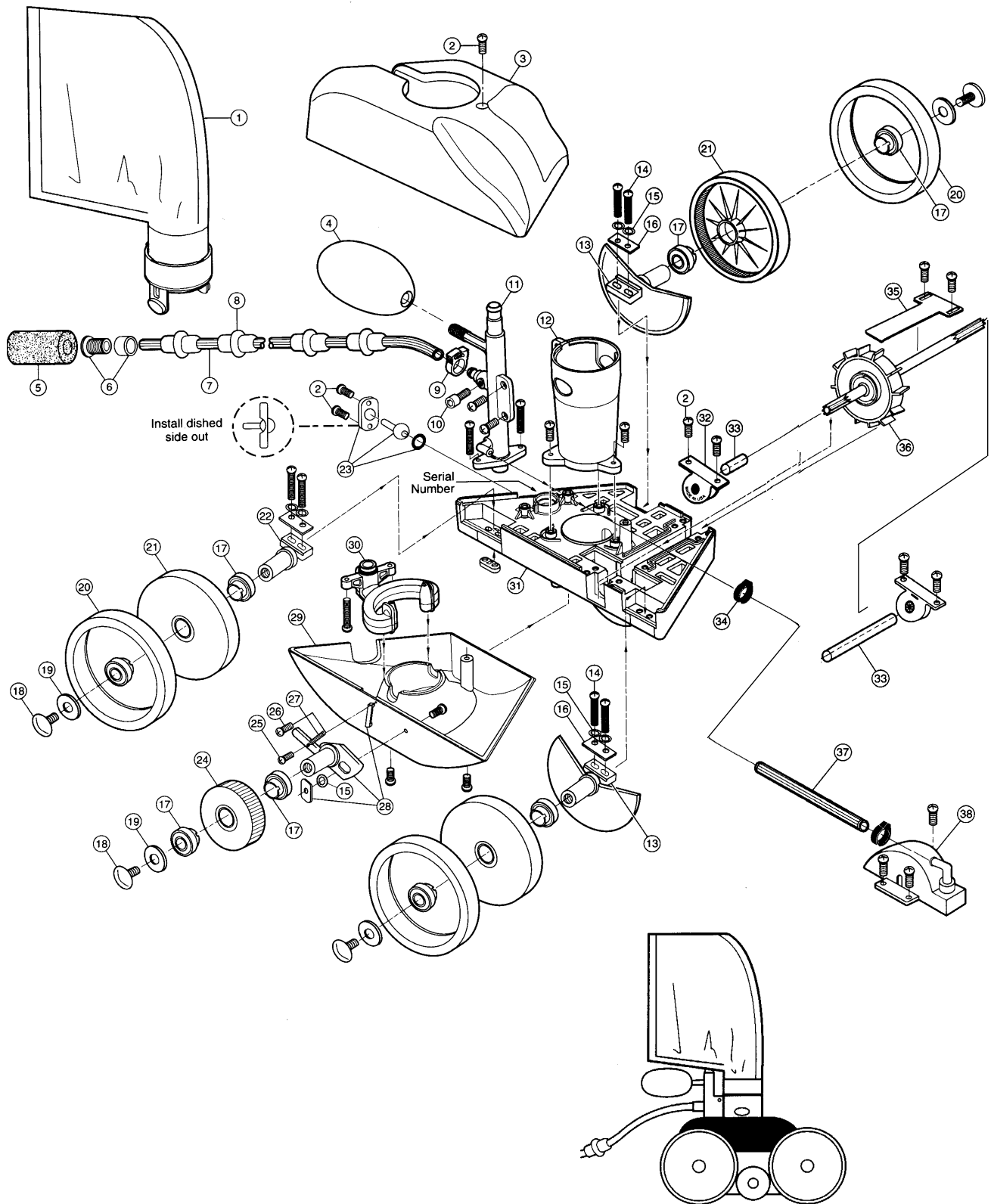

**POLARIS 280 VAC-SWEEP
Booster Pump Cleaner**

KEY	MFG NO.	DESCRIPTION	ITEM NO.
---	F-5	Polaris 280 Head/Hose w/Pump	E2024
---	F-5	Polaris 280 Head/Hose w/o Pump	E2006
1	K-16	Sand/Silt Bag	E2K16
2	C-40	Screw, 10-32 x 3/8" SS Pan Hd	E2C40
3	K-5	Top, Blue	E2K05
4	A-20	Float, Head	E2A20
5	9-100-3105	Sweep Hose Scrubber	E2514
6	B-25	Orifice Tip w/ Orifice Tip Guard	E2B25
7	B-5	Sweep Hose Complete	E2B05
8	B-10	Wear Rings	E2B10
9	B-15	Sweep Hose Attach Clamp	E2B15
10	B-20	Adjustment Screw, Sweep Hose	E2B20
11	K-30	Feed Pipe w/ Elbow	E2K30
12	K-20	Vacuum Tube	E2K20
13	C-66	Axle, Large (with Sand/Gravel Guard)	E2C66
14	C-76	Screw, 10-32 x 7/8" SS Pan Hd	E2C76
15	C-45	Lock Washer for C-36	E2C45
16	C-70	Axle Plate for C-36	E2C70
17	C-60	Ball Bearings, Wheels	E2C60
18	C-55	Wheel Screw, Plastic	E2C55
19	C-64	Wheel Washer, Plastic	E2C64
20	C-10	Tire, White	E2C10
21	C-6	Wheel, Large (no bearings included)	E2C06
22	C-65	Axle, Large (rear wheel only)	E2C65
23	C-131	Thrust Jet Kit	E2C31
24	C-16	Idler Wheel, White	E2C16
25	C-30	Screw, 4-40 x3/16" SS Pan Hd	E2C30
26	C-32	Screw, 6-32 x 1/2" SS Pan Hd	E2C32
27	C-25	Spring for C-36	E2C25
28	C-36	Swing Axle Kit	E2C36
29	K-10	Bottom, White with Bracket	E2K10
30	K-25	Water Management System	E2K25
31	K-145	Frame, (Exchange Only)	E2K145
32	C-80	Ball Bearings, Turbine	E2C80
33	C-83	Turbine Shaft Tubes	E2C83
34	9-100-7170	Hose Clamp for WMS	E2570
35	A-40	Turbine Shaft Shield	E2A40
36	C-86	Drive Shaft Assembly	E2C86
37	C-120	Hose for C-110, 7 1/2"	E2C81
38	C-110	Turbine Cover with Elbow	E2C97

POLARIS 280 VAC-SWEEP Hose Assemblies & Back-up Valve

KEY	MFG NO.	DESCRIPTION	ITEM NO.
39	9-100-9001	UWF Connector Assy (Replaces D-27)	E2522
40	10-108-00	UWF Restrictor Kit	E2602
41	6-500-00	Universal Wall Fitting (UWF)	E2524
42	6-504-00	Filter Screen, UWF/QD	E2578
43	6-505-00	O-ring, UWF/QD	E2573
44	9-100-9002	Pressure Relief Valve (Replaces D-28)	E2564
45	D-29	Quick Disconnect, UWF	E2D29
46	D-15	Nut, Feed Hose	E2D15
48	D-20	Swivel, Ball Bearing	E2D20
49	D-10	Float, Feed Hose	E2D10
50	D-45	Feed Hose, White, 10Ft., Hard	E2D45
51	D-50	Feed Hose, Clear, 10 Ft., Soft	E2D50
52	G-52	Back-up Valve Kit	E2G52
53	G-54	Case Kit for G-52	E2G54
54	G-53	Mechanism for G-52	E2G53
--	G-56	Back-up Booster Valve Seat (Increases power of G-52 Valve)	E2G56
--	A-49	Polaris 280/180 Tune-up Kit	E2A49
--	G-5	Feed Hose Complete, No Back-Up Valve	E2G05
--	G-21	Ladder Guard Set, 2 Panels	E2G21
--	G-45	Sand/Silt Bags, Pkg.4, Disposable	E2G45
--	G-118	Over Deck Mount	E2G71
--	K-6	Top, Black	E2K06
--	K-15	Leaf Bag	E2K15

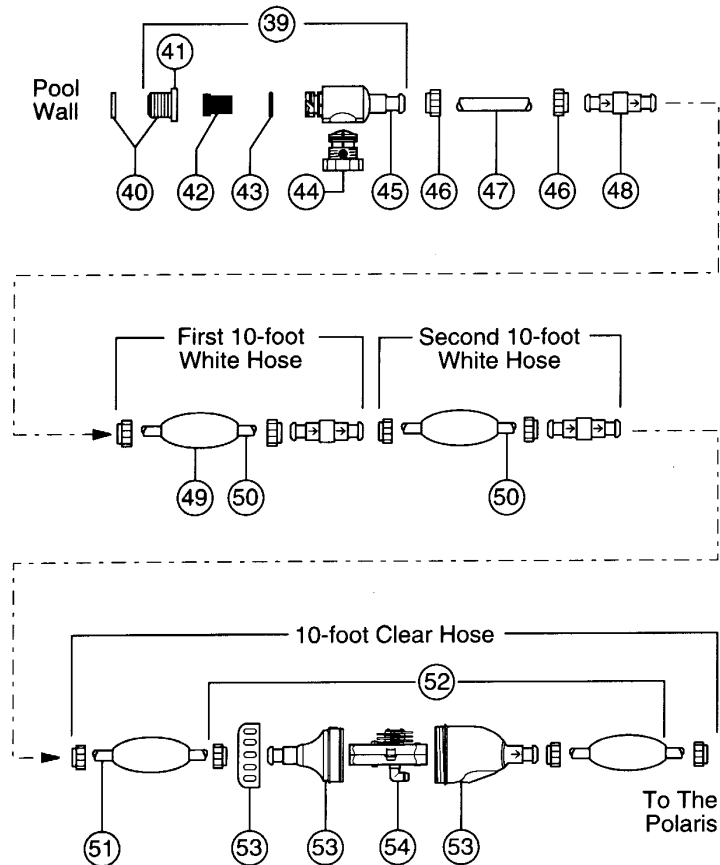

Complete Product on page 60

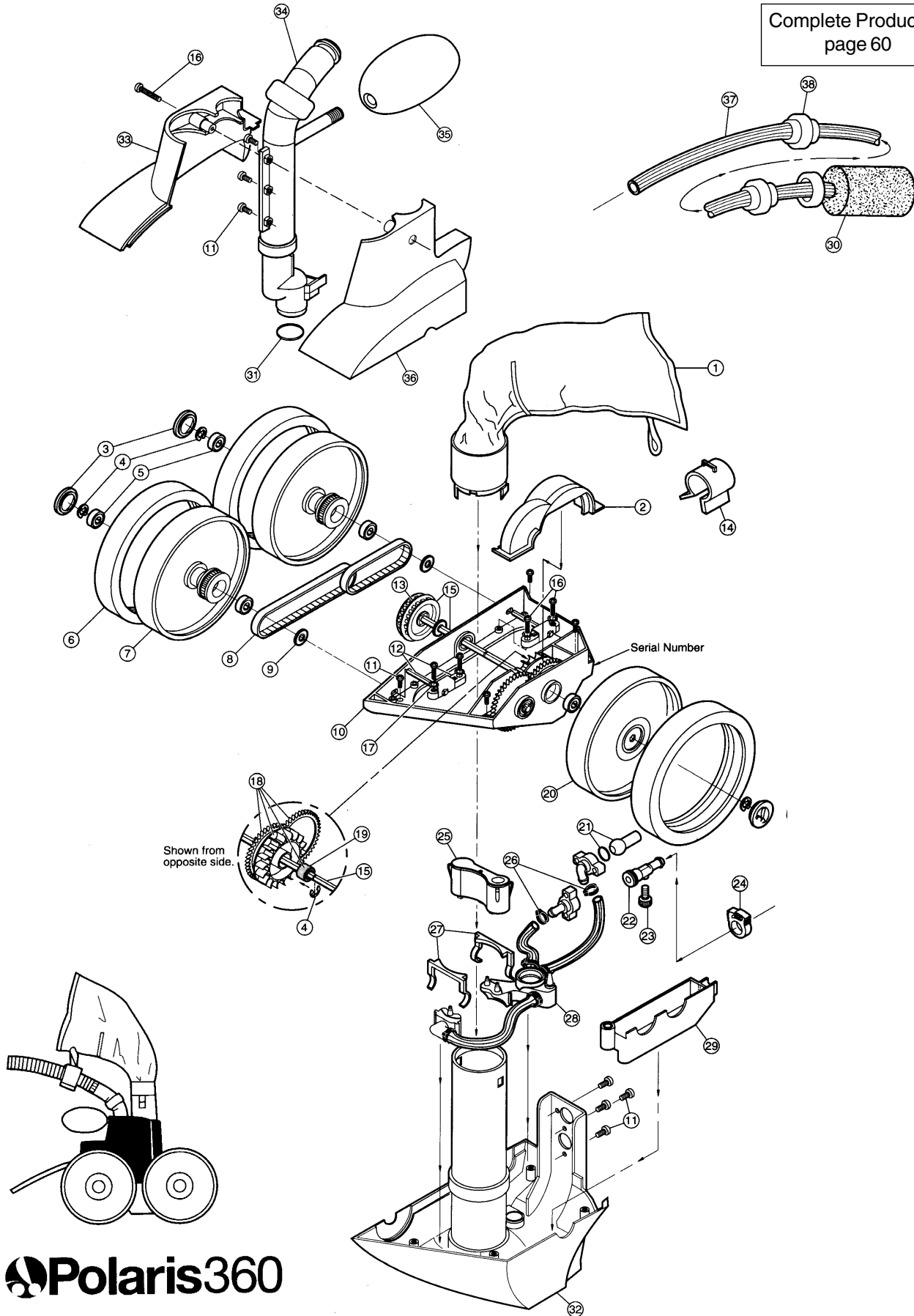

POLARIS 360 VAC-SWEEP Non-booster Pump Cleaners

KEY	MFG NO.	DESCRIPTION	ITEM NO.
1	9-100-1014	All Purpose Bag	E2511
—	9-100-1012	Leaf Bag	E2519
—	9-100-1015	Ultra Fine Sand/Silt Bag	E2513
2	9-100-1152	Housing Turbine Upper	E2536
3	9-100-1114	Hub Cap	E2520
4	9-100-5107	E-clip, Stainless Steel	E2515
5	9-100-1108	Ball Bearing	E2540
6	C-10	Tire, White	E2C10
—	C-11	Tire, Black	E2C11
—	C-12	Tire, Krayton	E2C12
7	9-100-1008	Wheel, Double-side	E2518
8	9-100-1017	Belt Kit, Small and Large	E2527
9	9-100-7011	Shield, Bearing	E2541
10	9-100-1005	Frame, Exchange Only	E2572
11	9-100-5117	Screw, 8-32 x 3/8" SS Pan Hd	E2543
12	9-100-1139	Axle Block Assembly	E2542
13	9-100-1010	Belt Divider, Transfer Pulley	E2608
14	9-100-3135	Collar, Bag Tie	E2574
15	9-100-1007	Transfer Pulley/Drive Shaft Assy	E2517
16	9-100-5115	Screw, 8-32 x 3/4" SS Pan Hd	E2538
17	9-100-5130	Lock Washer, Axle Block	E2616
18	9-100-1132	Drive Train Gear Kit w/Bearing	E2571
19	9-100-1170	Turbine Bearing	E2545
20	9-100-1116	Wheel, Single-side	E2521
21	C-131	Thrust Jet Kit	E2C31
22	9-100-7008	Sweep Hose Barb Complete	E2548
23	B-20	Adjustment Screw, Sweep Hose	E2B20
24	B-15	Sweep Hose Attach Clamp	E2B15
25	9-100-3005	Base Weight	E2611
26	9-100-7170	Hose Clamp for WMS	E2570
27	9-100-7009	Jet Retainer	E2547
28	9-100-7014	Water Management System	E2575
29	9-100-1155	Housing, Turbine Lower	E2561
30	9-100-3105	Sweep Hose Scrubber	E2514
31	9-100-5132	O-ring, In-head Timer/Feed Pipe Assy	E2546
32	9-100-7016	Base Assy for In-line Back-up Valve, White	E2612
—	9-100-7017	Base Assy for In-line Back-up Valve, Black	E2613
33	9-100-1141	Top Cover, Double Wheel Side	E2537
—	9-100-1143	Top Cover, Double Wheel Side, Black	E2627
34	9-100-1002	Feed Pipe/Timer Blank Assembly	E2008
35	A-20	Float, Head	E2A20
36	9-100-1140	Top Cover, Single Wheel Side	E2539
—	9-100-1142	Top Cover, Single Wheel Side, Black	E2626
37	9-100-1011	Sweep Hose Complete	E2577
—	B-2	Weight Sweep Hose	E2B02

**POLARIS 360 VAC-SWEEP
Hose Assemblies & Back-up Valve**

KEY	MFG NO.	DESCRIPTION	ITEM NO.
39	9-100-3008	UWF Connector Assembly	E2530
40	6-500-00	Universal Wall Fitting (UWF)	E2524
41	6-504-00	Filter Screen, UWF/QD	E2578
42	6-505-00	O-ring, UWF/QD	E2573
43	9-100-3009	Pressure Relief Valve, White	E2523
44	9-100-3006	Quick Disconnect, UWF	E2582
45	9-100-3109	Hose Nut	E2534
46	9-100-3102	Feed Hose, 6 Ft.	E2532
47	9-100-3002	Swivle, Hose	E2529
48	9-100-1206	Float, Hose	E2624
49	9-100-1200	In-line Back-up Valve	E2620
50	9-100-1202	Case Kit, In-line Back-up Valve	E2621
51	9-100-1204	Mechanism, In-line Back-up Valve	E2622
52	9-100-3103	Feed Hose, 1 Foot	E2584

Parts Not Shown

—	6-511-00	UWF Eyeball Fitting	E2505
—	6-550-00	UWF, Black	E2507
—	9-100-1003	In-head Timer Assembly	E2512
—	9-100-1009	Feed Pipe	E2576
—	9-100-3100	Feed Hose Complete - No Valve	E2531
—	9-100-3126	Hose Nut, Quick Disconnect	E2559
—	9-100-3128	Weight, Feed Hose	E2583
—	9-100-3200	In-line Back-up Valve Conversion Kit	E2615
—	9-100-5140	O-ring, Quick Disconnect	E2560
—	9-100-6400	Pressure Gauge Kit	E2618
—	9-100-7012	Base Assy, In-head Timer, White	E2562
		<i>(starting w/ serial # 512220)</i>	
—	9-100-7168	Spacer, Shaft (single wheel only)	E2544
—	9-100-8021	Vinyl Eyeball Kit	E2672
—	9-100-9010	Polaris 380/360 Factory Tune-up Kit	E2601
—	10-107-00	Eyeball Regulator	E2671

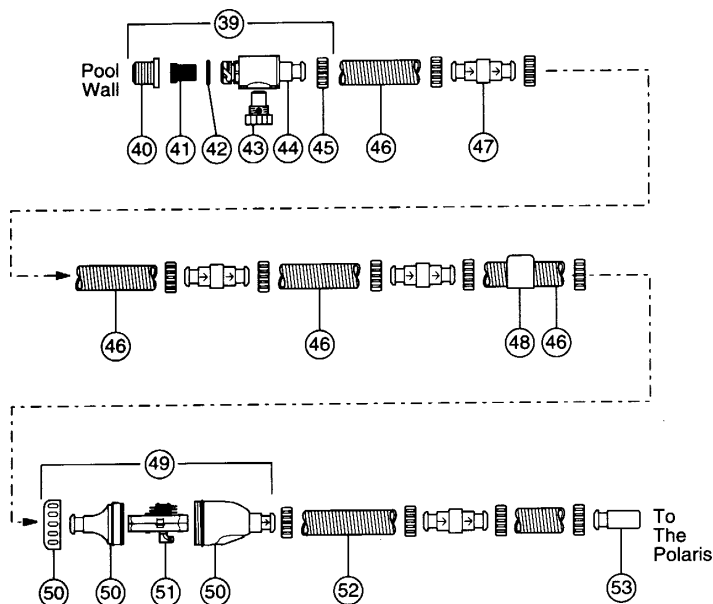

**Eyeball Fitting Connection Kit
(part #9-100-8001)**

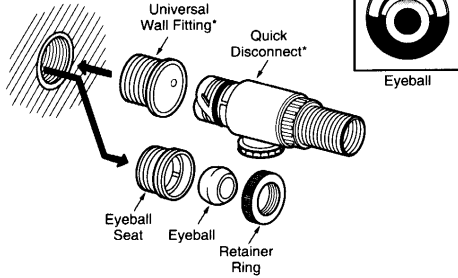

**1 1/2" Stub Pipe Connection Kit
(part #9-100-8003)**

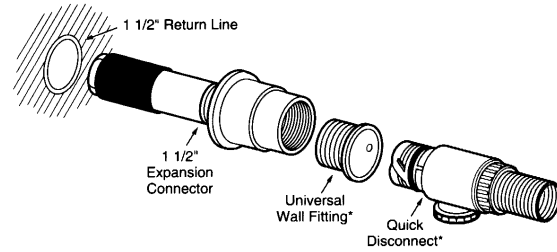

**1" Stub Pipe Connection Kit
(part #9-100-8002)**

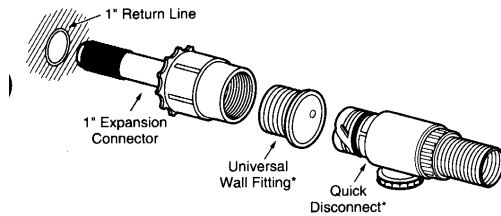

**Eyeball Adapter Connection Kit
(part #9-100-8005)**

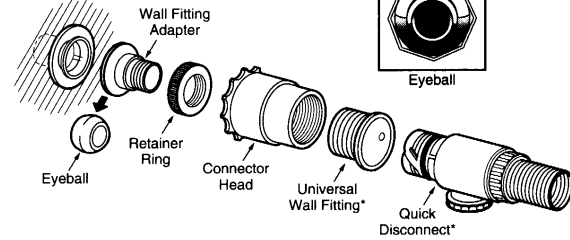

**1 1/4" Sleeve Kit (part #8-841-00)
(Use with 1" Stub Pipe Kit)**

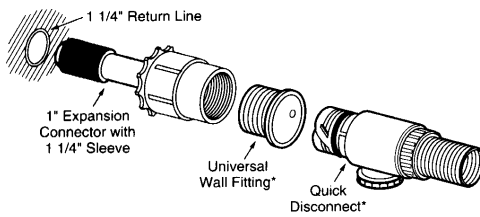

CONNECTION KITS

MFG. NO.	DESCRIPTION	ITEM NO.
8-841-00	1-1/4" Sleeve Kit	E2589
9-100-8001	Eyeball Fitting Connection Kit	E2587
9-100-8002	1" Stub Pipe Connection Kit	E2528
9-100-8003	1-1/2" Stub Pipe Connection Kit	E2533
9-100-8005	Eyeball Adapter Connection Kit	E2588
9-100-8006	Standard Eyeball Regulator Disk	E2665
9-100-8007	1" Return Line Plug	E2700
9-100-8008	1" Expansion Connector	E2701
9-100-8009	1" Expansion Connector w/Pressure Relief	E2702
9-100-8010	1-1/2" Return Line Plug	E2703
9-100-8011	1-1/2" Expansion Connector	E2704
9-100-8012	1-1/2" Expansion Connector w/Pressure Relief	E2705
9-100-8013	1-1/2" Adapter with Cap	E2706
9-100-8014	1-1/2" Pressure Relief Valve Assy	E2707
9-100-8015	Eyeball Adapter Connector w/Pressure Relief	E2708
9-100-8016	Eyeball Adapter Connector	E2709
9-100-8017	Large Eyeball Regulator Disk	E2710
9-100-8018	1" Expansion Regulator	E2711
9-100-8019	3/4" Expansion Regulator	E2712
9-100-8020	1/2" Expansion Regulator	E2713

Complete Product on page 60

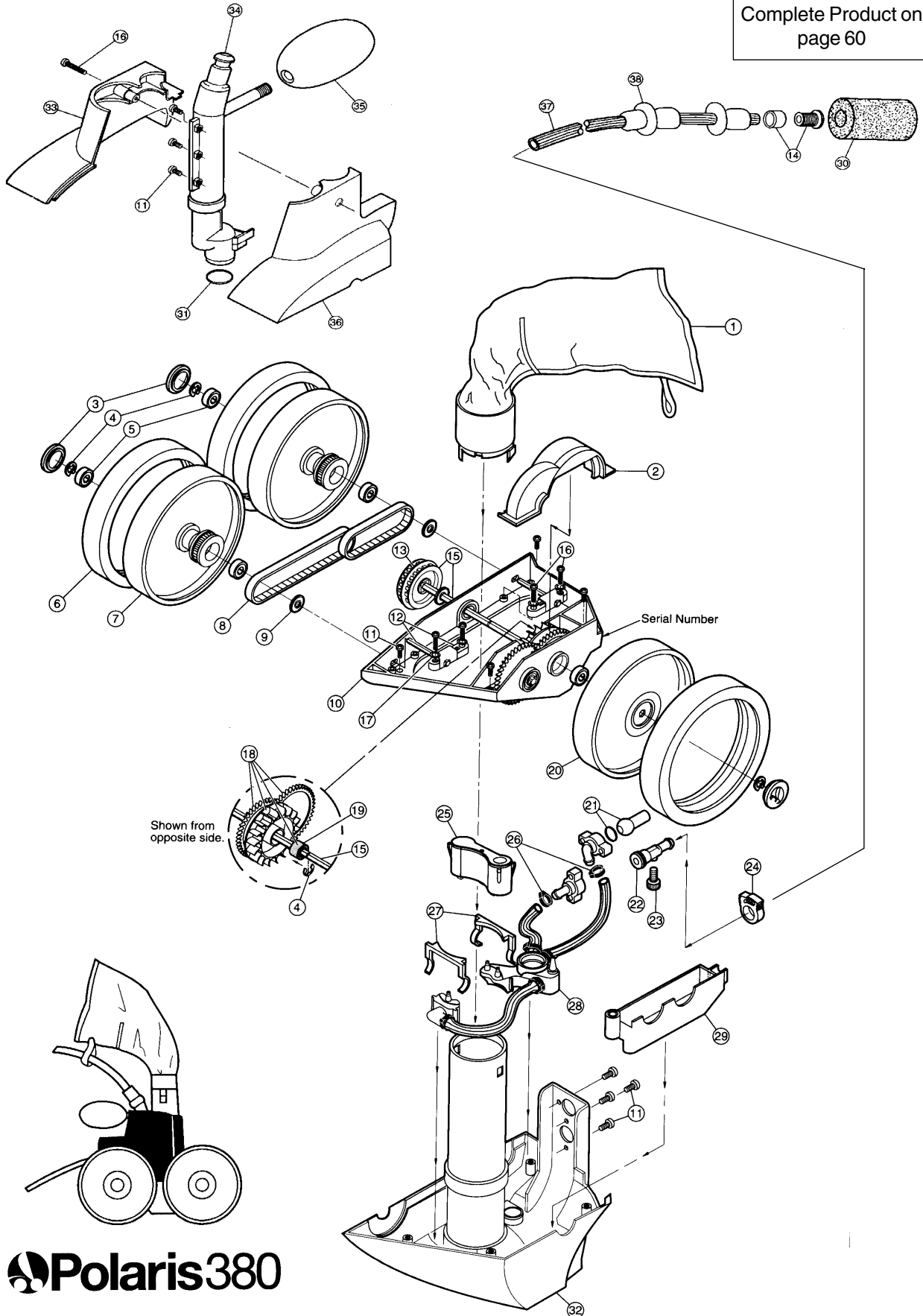

POLARIS 380 VAC-SWEEP Booster Pump Cleaners

KEY	MFG NO.	DESCRIPTION	ITEM NO.
1	9-100-1014	All Purpose Bag	E2511
--	9-100-1012	Leaf Bag	E2519
--	9-100-1015	Ultra Fine Sand/Silt Bag	E2513
--	G-45	Sand/Silt Bag, Pkg 4 (Disposable)	E2G45
2	9-100-1152	Housing, Turbine Upper	E2536
3	9-100-1114	Hub Cap	E2520
4	9-100-5107	E-clip SS	E2515
5	9-100-1108	Ball Bearing	E2540
6	C-10	Tire, White	E2C10
--	C-11	Tire, Black	E2C11
--	C-12	Tire, Krayton	E2C12
7	9-100-1008	Wheel, Double Side	E2518
8	9-100-1017	Belt Kit, Small and Large	E2527
9	9-100-7011	Shield, Bearing	E2541
10	9-100-1005	Frame, Exchange Only	E2572
11	9-100-5117	Screw, 8-32 x 3/8" SS Pan Hd	E2543
12	9-100-1139	Axle Body Assembly	E2542
13	9-100-1010	Belt Divider, Transfer Pulley	E2608
14	B-25	Orafice Tip w/Orifice Tip Guard	E2B25
15	9-100-1007	Transfer Pulley/Drive Shaft Assy	E2517
16	9-100-5115	Screw, 8-32 x 3/4" SS Pan Hd	E2538
17	9-100-5130	Lock Washer, Axle Body	E2616
18	9-100-1132	Drive Train Gear Kit w/Turbine Bearing	E2571
19	9-100-1170	Turbine Bearing	E2545
20	9-100-1116	Wheel, Single Side	E2521
21	C-131	Thrust Jet Kit	E2C31
22	9-100-7008	Sweep Hose Barb Complete	E2548
23	B-20	Adjustment Screw, Sweep Hose	E2B20
24	B-15	Sweep Hose Attach Clamp	E2B15
25	9-100-9004	Base Weight	E2610
26	9-100-7170	Hose Clamp for WMS	E2570
27	9-100-7009	Jet Retainer	E2547
28	9-100-7010	Water Management System	E2549
29	9-100-1155	Housing, Turbine Lower	E2561
30	9-100-3105	Sweep Hose Scrubber	E2514
31	9-100-5132	O-ring, In-head Timer/Feed Pipe	E2546
32	9-100-7016	Base Assy for In-line Back-up Valve, White	E2612
33	9-100-1141	Top Cover, Double Wheel Side	E2537
--	9-100-1143	Top Cover, Double Wheel Side (Black)	E2627
34	9-100-7003	Feed Pipe/Timer Blank Assy	E2605
35	A-20	Float, Head	E2A20
36	9-100-1140	Top Cover, Single Wheel Side	E2539
--	9-100-1142	Top Cover, Single Wheel Side (Black)	E2626
37	B-5	Sweep Hose Complete	E2B05
38	B-10	Wear Rings	E2B10
--	B-2	Weight, Sweep Hose	E2B02

Complete Product on page 61

POLARIS BOOSTER PUMP - PB4-60

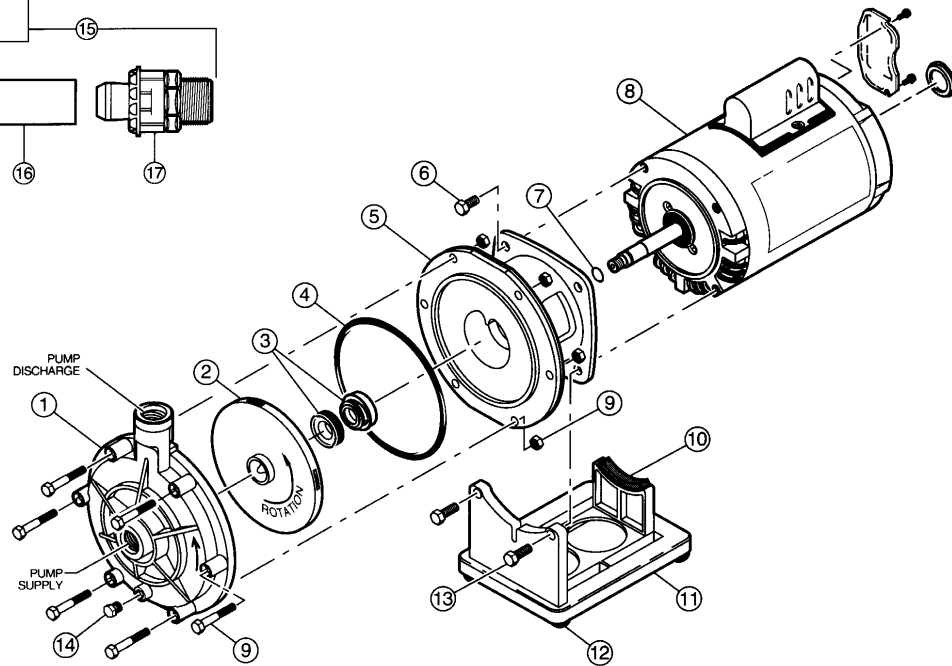

KEY	MFG NO.	DESCRIPTION	ITEM NO.
—	PB4-60	Polaris Booster Pump	E2000
1	P-5	Volute (includes drain plug)	E2P05
2	P-15	Impeller	E2P15
3	P-55	Seal, Stainless Cup/Spring	E2P55
4	P-95	O-ring, Bracket	E2P95
5	P-10	Bracket	E2P10
6	P-35	Bolt, SS, Bracket to Motor	E2P35
7	P-40	O-ring for Shaft	E2P40
8	P-61	Motor, 3/4 HP, Threaded Shaft	E2P61
9	P-25	Bolt/Nut, S.S., for Volute to Bracket	E2P25
10	P-80	Rubber Strip, Motor/Bracket	E2P80
11	P-70	Pump Stand w/ Feet, Strip	E2P70
12	P-75	Rubber Feet	E2P75
13	P-65	Bolt, S.S., Stand to Bracket & Motor	E2P65
14	P-20	1/8" NPTM Plug, Plastic	E2P20
15	P-17	Installation Kit w/ Quick Connects	E2P17
16	P-18	Pump Hose, 3 Ft., Flex. Reinforced	E2P18
17	P-133	Softube (TM) Quick Connect	E2P133

Parts Not Shown

—	G-16	Adapter 3/4" NHTMxNPTM, Pump	E2G16
—	G-17	Nipple 3/4" NPTMxNPTM, G-12 Only	E2G17
—	G-133	Hose Barb and Clamp	E2G133
—	P-45	Shaft for Impeller	E2P45
—	P-50	Set Screw for Shaft	E2P50
—	P-53	Pressure Restrictor	E2P53
—	P-135	Pump Hose Spool, 25 Ft.	E2P135

Polaris Booster Pump - PB4-60Q Halcyon

Complete Product on
page 61

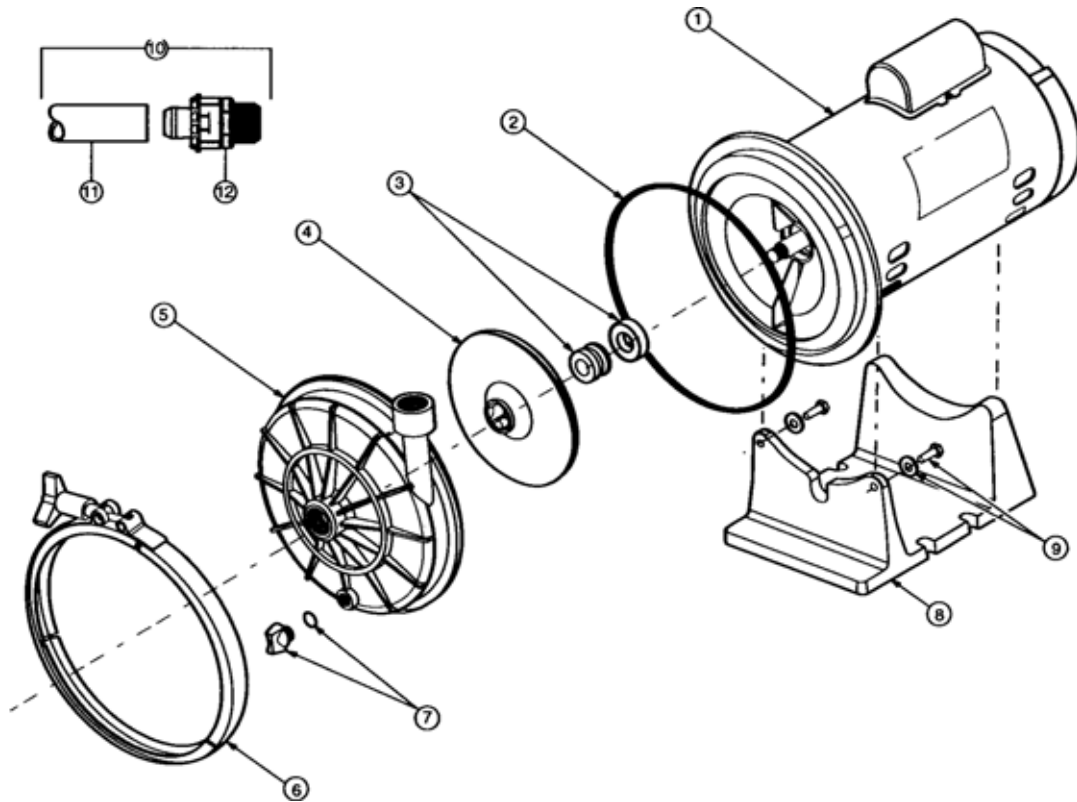

—	PB4-60Q	Complete Halcyon Booster Pump	E2004
1	P64	3/4 HP Motor - Seal Plate Assembly	*
2	P85	O-Ring, Seal Plate	E2P85
3	P84	Seal, Ceramic / Spring	E2P84
4	P16	Impeller	E2P16
5	P82	Volute Includes Drain Plug w/O-Ring	E2P82
6	P87	Band Clamp	E2P87
7	P88	1/2" - 20 UNF Drain Plug w/O-Ring	E2P88
8	P86	Pump Stand	E2P86
9	P91	1/4 - 20 x 3/4" Bolt w/Washer	*
10	P17	Softube Hose, 6', Flexible Reinforced	E2P17
11	P19	Pump Hose, 6', Flexible Reinforced	E2P19
12	P133	Softube Quick Connect	E2P133

Hayward Swim Clear	331
Jacuzzi TRI-C.L.O.P.S.....	332
Jandy CL Series	333
Pentair (Pac-Fab) Clean & Clear/Predator	334
Pac-Fab Clean & Clear Plus.....	335-336
Replacement Cartridges (Pools).....	126-128
Replacement Cartridges (Spas)	129-131

Filters (Cartridge)

Hayward Swim Clear Filters

Complete Product on
Page 123

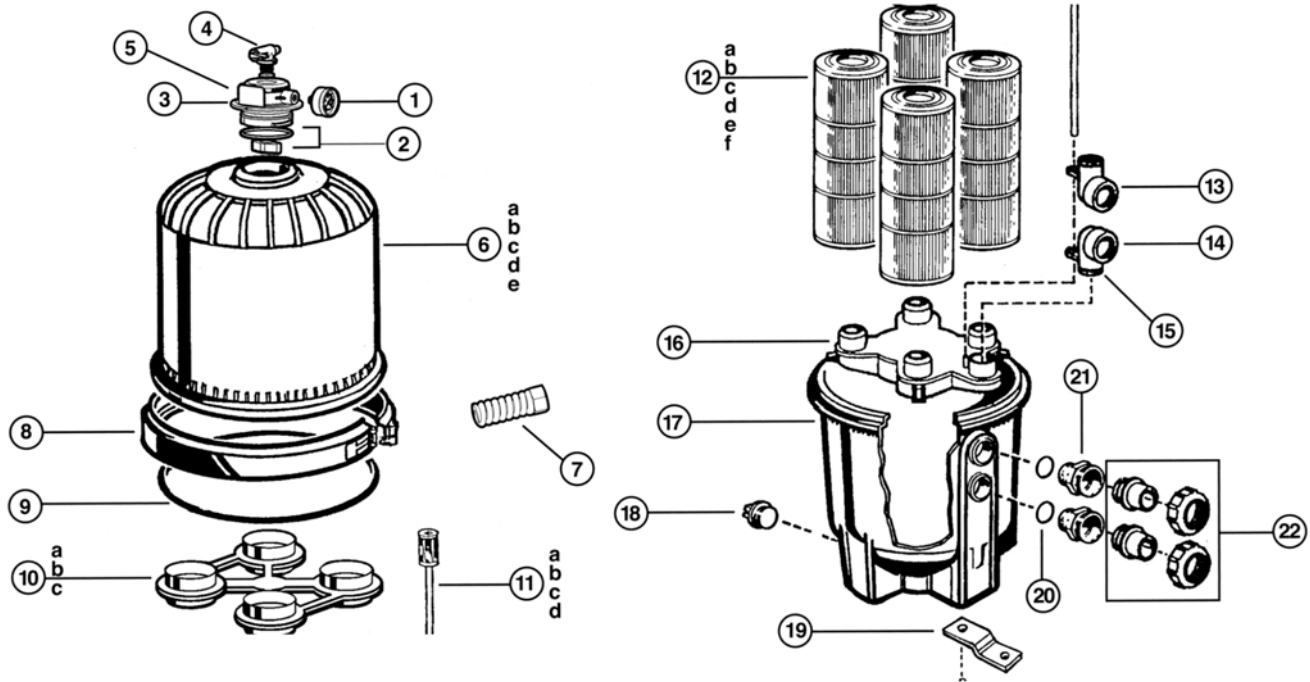

1	ECX2712B1	Pressure Gauge
2	DEX2420Z8A	O-ring Kit
3	CCX1000N	Manual Air Relief Valve Nut
4	CCX1000V	Manual Air Relief Valve
5	DEX2420MAR	Manual Air Relief Assembly
6a	DEX2420BT	Filter Head
6b	DEX3620BT	Filter Head
6c	DEX4820BT	Filter Head
6d	DEX6020BT	Filter Head
6e	DEX7220BT	Filter Head
7	DEX2420J1KIT	Clamp Spring Assembly Replacement Kit (includes washer w/small hole, spring, washer w/large hole, brass sleeve nut)
8	DEX2420J1	Clamp Assembly w/ Spring Assembly
9	DEX2400K	Filter Tank O-ring
10a	CX2020DA	Top Closure Plate (C2020)
10b	CX3020DA	Top Closure Plate (C3020 & C4020)
10c	CX5020DA	Top Closure Plate (C5020)
11a	CX800Z4A	Air Relief Tube w/Screen (C2020/C2025)
11b	CX3000Z3	Air Relief Tube w/Screen (C3020/C3025)
11c	CX4000Z3	Air Relief Tube w/Screen (C4020/C4025)
11d	CX5000Z3	Air Relief Tube w/Screen (C5020/C5025)

12a	CX480XRE	Replacement Element (C2020/C2025)
12b	CX580XRE	Replacement Element (C3020/C3025)
12c	CX880XRE	Replacement Element (C4020/C4025)
12d	CX875RE	Replacement Element (C4520 Series)
12e	CX1280XRE	Replacement Element (C5020/C5025)
12f	CX1380RE	Replacement Element (C5520 Series)
13	CX3000F1	Inlet Elbow
14	CX3020FB	Outlet Elbow
15	DEX360M	O-ring
16	CX3000C	Bottom Collector Manifold
17	DEX2420AT	Filter Body - Taupe
18	SP1022C	Drain Plug 1 1/2" w/O-ring
19	DEX2420DCKIT	Strap Kit (2 straps, 2 screws)
20	SX220Z2	O-ring
21	DEX2420F	Bulkhead Fitting
22	DE2400PAK2CS	Plumbing Kit (includes 2 O-rings, 2 slip connectors and 2 locknuts)

JACUZZI TRI-C.L.O.P.S. ELEMENT FILTER
TC-300, TC450 & TC-600

Complete Product on
 Page 124

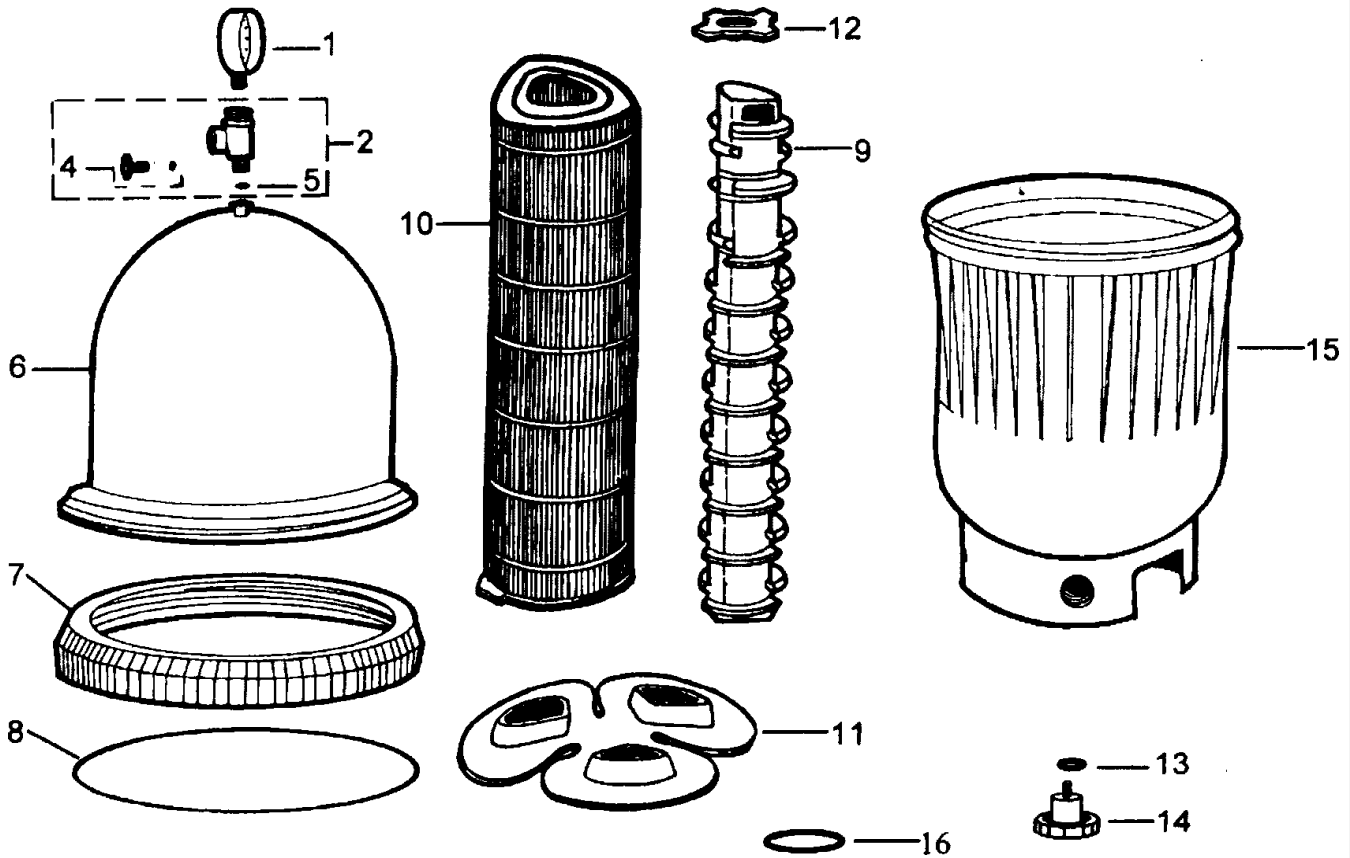

KEY	MFG.NO.	DESCRIPTION	ITEM NO.
1	9193-4158-R	Pressure Gauge O-60#	H8368
2	42-2972-00-R	Tee Air Bleed 1/4" - PVC (includes # 4, # 5)	H8111
4	39-2547-01-R	Air Bleed Valve Knob	H8193
5	47-0112-00-R	O-Ring 1/2" x 11/16 x 3/32 B-N	H8181
6	42-2930-01-R	Top for TC-300	H8112
6	42-2931-00-R	Top for TC-450	H8113
6	42-2932-09-R	Top for TC-600	H8114
7	42-2935-06-R	Aluminum Filter Nut	H8117
8	47-0569-99-R	Tank O-Ring - 20"	H8118
9	42-3637-05-R	Standpipe Support Assy. for TC-300	H8545
9	42-3640-00-R	Standpipe Support Assy. for TC-450	H8546
9	42-3643-07-R	Standpipe Support Assy. for TC-600	H8547
10	42-3640-10-R	Replacement Element for TC300 (3 needed)	H9420
10	42-3640-15-R	Replacement Element for TC450 (3 needed)	H9422
10	42-3640-20-R	Replacement Element for TC600 (3 needed)	H9424
11	42-3652-05-R	Element Manifold	H8548
12	14-4248-08-R	Retainer Ring	H8549
13	47-0212-66-R	O-Ring .986 x 1.276 x .145	H8149
14	42-3653-04-R	Manifold Ret Knob w/ Washer	H8574
15	42-2934-07-R	Filter Bottom	H9220
16	47-0228-68-R	O-Ring 2-1/4 x 2-1/2 x 1/8	H8354

JANDY CL SERIES

Complete Product on
Page 124

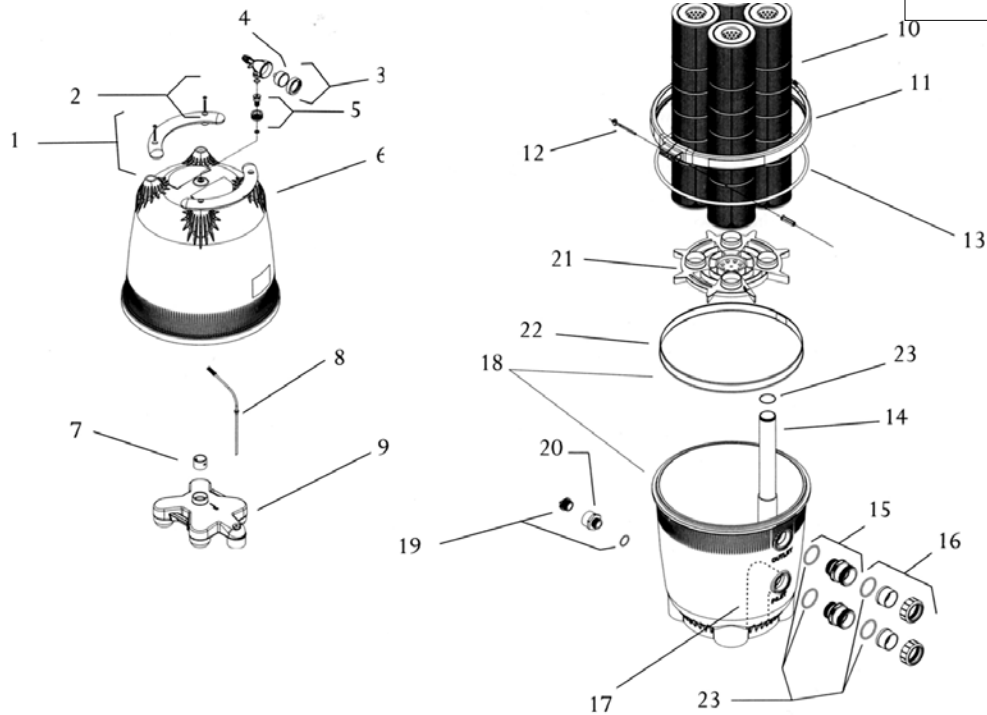

1	R0357100	Handle Assembly w/hardware (set of 2)
2	R0359900	Handle Hardware (set of 4)
3	R0357200	Gauge / Air Release Assembly
4	R0359600	Pressure Gauge
5	R0552000	Tank Adapter w / O-ring
6	R0357300	Tank Top CL580
	R0554700	Tank Top CL340 & CL460
7	R0357700	Top Spacer
8	R0358700	Breather Tube Assembly
9	R0357600	Manifold Assembly
10	R0357900	CL580 Filter Cartridge, 145 sq. ft. (4 Req'd)
	R0554600	CL460 Filter Cartridge, 115 sq. ft. (4 Req'd)
	R0554500	CL340 Filter Cartridge, 85 sq. ft. (4 Req)
11	R0357400	Tank Clamp Ring w/Knob Assembly
12	R0357500	Clamp Ring Knob Assembly w/Threaded Rod and Retainer
13	R0357800	Tank O-ring
14	R0358100	CL580 Outlet Tube/Elbow Assembly w/ O-rings
	R0358200	CL460 & CL340 Outlet Tube/Elbow Assembly w/ O-rings
15	R0358200	Bulkhead Assembly w/ O-ring
16	R0328300	Coupling Nuts w/ Flange & O-ring (set of 2)
17	R0358400	Inlet Elbow w/ O-ring
18	R0358600	Tank Bottom w/ Retaining Ring and Drain Plug
19	R0358800	Drain Plug w/ O-ring
20	R0395500	Large Tank Drain Adapter w/ O-ring
21	R0358500	Filter Cartridge Support
22	R0405200	Large Tank Retaining Ring
23	R0442500	"O"-ring kit, Outlet Tube, Bulkhead Assy
	R0358000	Large Tank O-ring Replacement Kit (not shown)
	H0238700	Installation/Operation Manual (not shown)
	R0443700	Gauge Adapter Kit (not shown) (1 brass pump adapter and 1 thermoplastic filter adapter)

PENTAIR (PAC-FAB) CLEAN & CLEAR / PREDATOR FILTERS

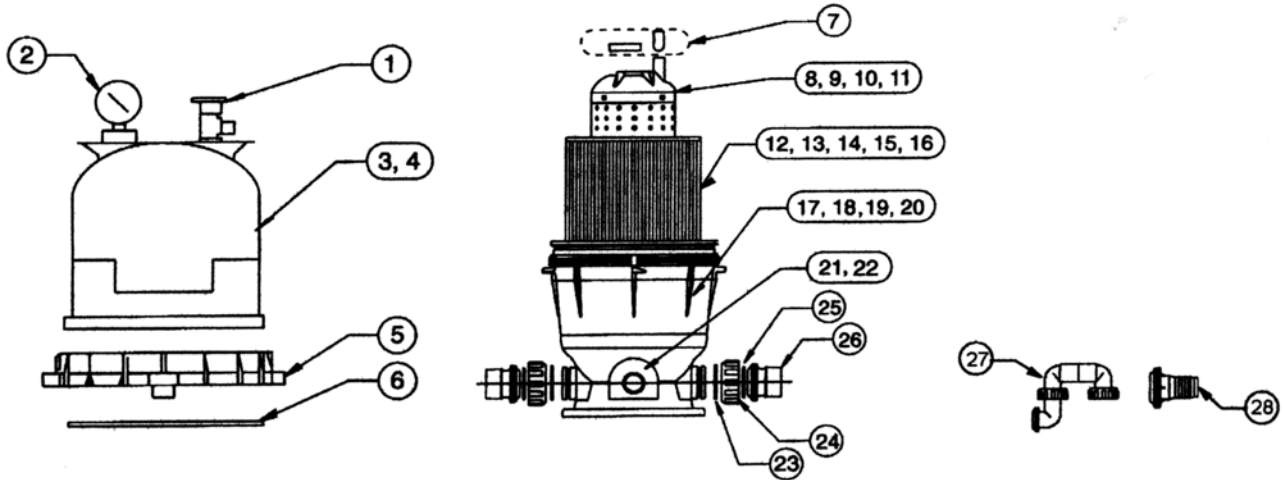

REF.	PART NO.	DESCRIPTION	REPLACES
1	98209800	High Flow Manual Air Relief Valve	H3561
2	53003201	Pressure Gauge, Bottom Mount	H3500
2	-----	Generic Pressure Gauge, Bottom Mount, Plastic	H7000
2	-----	Generic Pressure Gauge, Bottom Mount, Metal	H7003
3	178553	Lid, 50, 100 sq. ft. Filters - Almond	(after 11/98) H3480
3	59053000	Lid, 50, 100 sq. ft. Filters - Black	(before 11/98) H3482
4	178561	Lid, 75, 150, 200 sq. ft. Filters	(after 11/98) H3481
4	59053100	Lid, 75, 150, 200 sq. ft. Filters	(before 11/98) H3483
5	59052900	Locking Ring Assembly	H3484
6	87300400	Body O-Ring	H3485
7	59016200	Air Bleed Sock Kit	H3486
8	59053500	Center Core 50 sq. ft. Filter	H3487
9	59053600	Center Core 75 sq. ft. Filter	H3488
10	59053700	Center Core 100 sq. ft. Filter	H3489
11	59053800	Center Core 150, 200 sq. ft. Filter	H3490
12	59054000	Cartridge Element 50 sq. ft. Filter	H3491
13	59054100	Cartridge Element 75 sq. ft. Filter	H3492
14	59054200	Cartridge Element 100 sq. ft. Filter	H3493
15	59054300	Cartridge Element 150 sq. ft. Filter	H3494
16	59054400	Cartridge Element 200 sq. ft. Filter	H3495
17	178562	Bottom 50 sq. ft. Filter - Almond	(after 11/98) H3496
17	59055600	Bottom 50 sq. ft. Filter - Black	(before 11/98) H3668
18	178554	Bottom 75 sq. ft. Filter - Almond	(after 11/98) H3497
18	59056000	Bottom 75 sq. ft. Filter - Black	(before 11/98) H3752
19	178563	Bottom 100 sq. ft. Filter - Almond	(after 11/98) H3498
19	59055700	Bottom 100 sq. ft. Filter - Black	(before 11/98) H3753
20	178560	Bottom 150, 200 sq. ft. Filter - Almond	(after 11/98) H3499
20	59055200	Bottom 150, 200 sq. ft. Filter - Black	(before 11/98) H3704
21	51516200	Drain Cap Assembly	(before 11/98) H3431
21	86202000	Plug 1-1/2" w/ O-ring	(after 11/98) H3469
22	86300500	Drain Cap Gasket	(before 11/98) H8844
22	51005000	O-Ring for Drain Cap	(after 11/98) H8931
23	39104500	Union Nut "C" Clip	H3432
24	98212200	Union Nut	H3435
25	39102800	Union O-Ring	K3890
26	79304600	Body, Swivel	H3433
27	59019900	Pump Connector (before 6/96)	H3705
27	59018700	Pump Connector (after 6/96)	H3706
28	39105600	Outlet Connector (before 3/98)	H3707

PENTAIR (PAC-FAB) CLEAN & CLEAR PLUS FILTER

Fiberglass Reinforced Polypropylene Tank

Complete Product on Page 125

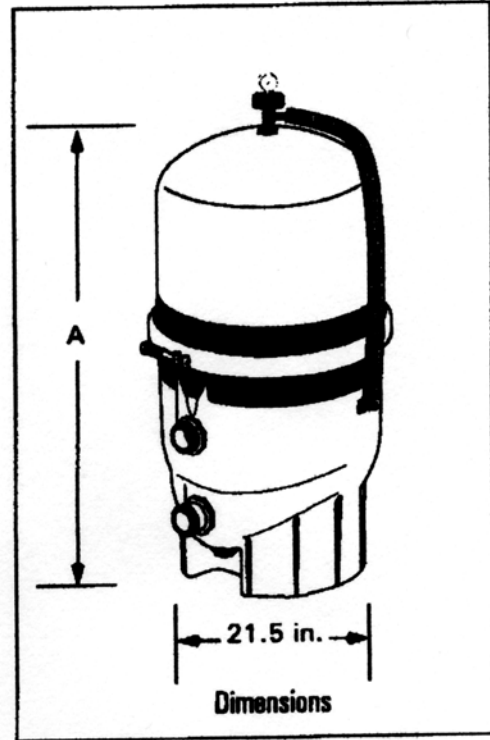
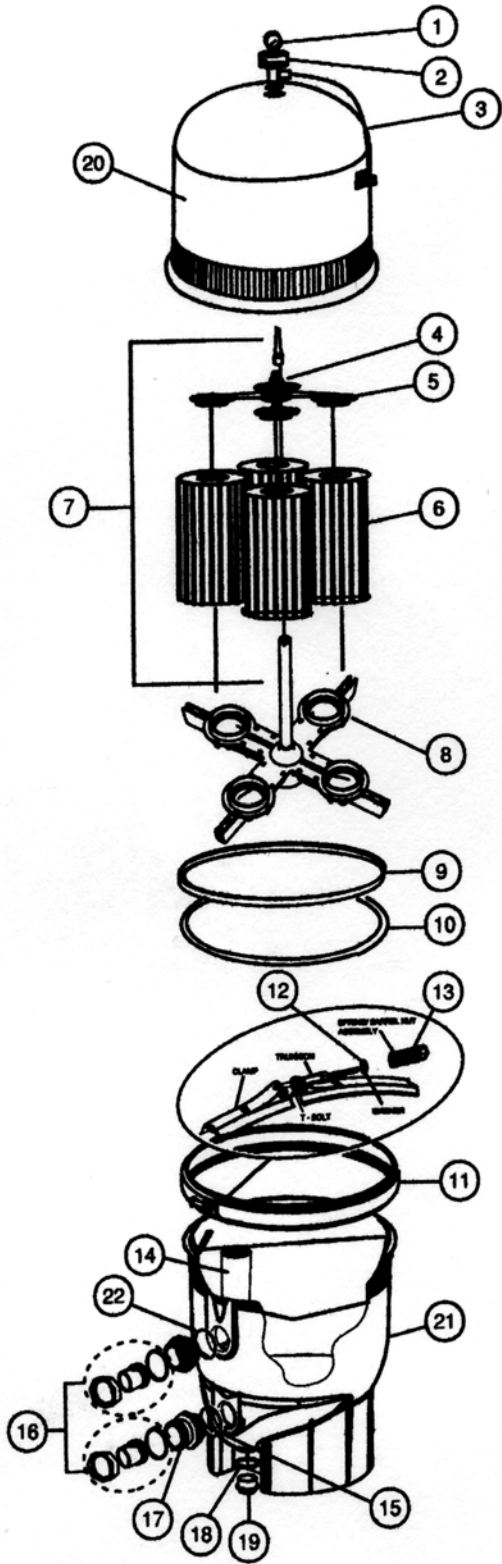

240, 320, 420 & 520 Sq. Ft. Series Filter

Flow Rate

Product #	Sq. Ft.	Dim. A	Flow					
			GPM ¹	GPM ²	GPM ¹	GPM ²	8 Hour ²	8 Hour ²
16-0310	240	37	120	90	7,200	5,400	32,400	43,200
16-0340	320	43	180	135	10,800	8,100	48,000	64,800
16-0301	420	49	250	183.5	15,000	11,250	67,500	90,000
16-0332	520	56	250	183.5	15,000	11,250	67,500	90,000

1. One GPM per sq. ft. is the cartridge rate, recommended flow rate is .5 GPM per sq. ft.
2. Commercial rate is .375 GPM per sq. ft. of filter area. Actual system flow will depend on plumbing size and other system components.

PENTAIR (PAC-FAB) CLEAN & CLEAR PLUS FILTER
Fiberglass Reinforced Polypropylene Tank

KEY	MFG NO.	DESCRIPTION	ITEM NO.
1	53003201	Pressure Gauge 1/4", Bottom Mount	H3500
1	-----	Generic Pressure Gauge, Plastic	H7000
1	-----	Generic Pressure Gauge, Metal	H7003
2	98209800	High Flow Manual Air Relief Valve	H3708
3	98201200	Hose & Retainer Clips for Air Relief Valve	H3565
4	56636900	Spring, Compression <i>(before 11/98)</i>	H3439
4	178616	Spring, Compression <i>(after 11/98)</i>	H3479
5	59071000	Manifold, Top Assembly <i>(before 11/98)</i>	H3440
5	170026	Manifold, Top Assy., 240 sq. ft. <i>(after 11/98)</i>	H3441
5	170027	Manifold, Top Assy., 320 & 520 sq. ft. <i>(after 11/98)</i>	H3442
6	178569	Cartridge Element, 240 sq. ft. <i>(4 needed)</i>	H3443
6	178580	Cartridge Element, 320 sq. ft. <i>(4 needed)</i>	H3444
6	56628300	Cartridge Element, 360 sq. ft. <i>(4 needed)</i>	H3445
6	178538	Cartridge Element, 420 sq. ft. <i>(4 req.) (before 11/98)</i>	H3446
6	178584	Cartridge, 420 sq. ft., <i>(4 needed) (after 11/98)</i>	H3447
6	56627900	Cartridge, 520 sq. ft. <i>(4 needed) (before 11/98)</i>	H3448
6	178585	Cartridge, 520 sq. ft. <i>(4 needed) (after 11/98)</i>	H3449
7	170030	Air Bleed Tube Assy., 240 sq. ft. <i>(before 11/98)</i>	H3451
7	55028500	Air Bleed Tube Assy, 360, 420 sq. ft. <i>(before 11/98)</i>	H3453
7	170029	Air Bleed Tube Assy., 320 sq. ft. <i>(after 11/98)</i>	H3455
7	170028	Air Bleed Tube Assy., 420 sq. ft. <i>(after 11/98)</i>	H3457
7	55028400	Air Bleed Tube Assy., 500 sq. ft. <i>(before 11/98)</i>	H3458
7	178583	Air Bleed Tube Assy., 520 sq. ft. <i>(after 11/98)</i>	H3459
8	56626800	Manifold, Bottom <i>(before 11/98)</i>	H3460
8	170031	Manifold, Bottom <i>(after 11/98)</i>	H3461
9	57000300	Gasket, Bottom Manifold <i>(before 11/98)</i>	H3462
10	39010200	O-Ring, Clamp	H3590
11	178565	Clamp Kit, Tension Control	H3463
12	53006300	Washer, .325 I.D. for Filter Clamp	H3657
13	53108900	Spring/Barrel Nut Assembly	H3501
14	55035000	Baffle, Bulkhead Assembly <i>(before 11/98)</i>	H3464
14	190039	Baffle, Bulkhead Assembly <i>(after 11/98)</i>	H3465
15	86006900	O-Ring, Bulkhead, Lower	H3637
16	98960311	Bulkhead Union (set) <i>(before 11/98)</i>	H3564
16	271096	Bulkhead Union, 1-1/2" x 2" (set) <i>(after 11/98)</i>	H4040
17	59019200	Pipe Assembly, Outlet <i>(before 11/98)</i>	H3467
17	170025	Pipe Assembly, Outlet <i>(after 11/98)</i>	H3468
18	86300500	Drain Cap Gasket <i>(before 11/98)</i>	H8844
18	51005000	O-Ring for Drain Plug <i>(after 11/98)</i>	H8931
19	51516200	Drain Cap <i>(before 11/98)</i>	H3431
19	86202000	Plug, 1-1/2" Drain with O-Ring <i>(after 11/98)</i>	H3469
20	170023	Tank, Lid Assembly, 240 sq. ft.	H3470
20	170024	Tank, Lid Assembly, 320 sq. ft.	H3471
20	178552	Tank, Lid Assembly, 360 sq. ft.	H3472
20	178551	Tank, Lid Assembly, 420 sq. ft. <i>(before 11/98)</i>	H3473
20	178581	Tank, Lid Assembly, 420 sq. ft. <i>(after 11/98)</i>	H3474
20	178550	Tank, Lid Assembly, 500 sq. ft. <i>(before 11/98)</i>	H3475
20	178582	Tank, Lid Assembly, 520 sq. ft. <i>(after 11/98)</i>	H3476
21	178559	Tank, Bottom Assembly <i>(before 11/98)</i>	H3477
21	178578	Tank, Bottom Assembly <i>(after 11/98)</i>	H3478
22	192320	O-Ring, Bulkhead, Upper <i>(after 11/98)</i>	H3141
22	86006900	O-Ring, Bulkhead, Upper <i>(before 11/98)</i>	H3637

Anthony Apollo VA38 & VA52	339-340
D.E. Replacement Grids	117-119
Hayward Pro Grid	341-342
Jacuzzi Earthworks EW Series	343-344
Jandy DEL	345
Pentair (Pac-Fab) FNS Plus Series	346-347
Pentair (Pac-Fab) FNS Series	348-350
Pentair (Pac-Fab) Star	351-352
ST-35, ST-50, ST-80	

ANTHONY APOLLO D.E. FILTER
Models VA-38, VA-52 (1-1/2") & VA-52 (2")

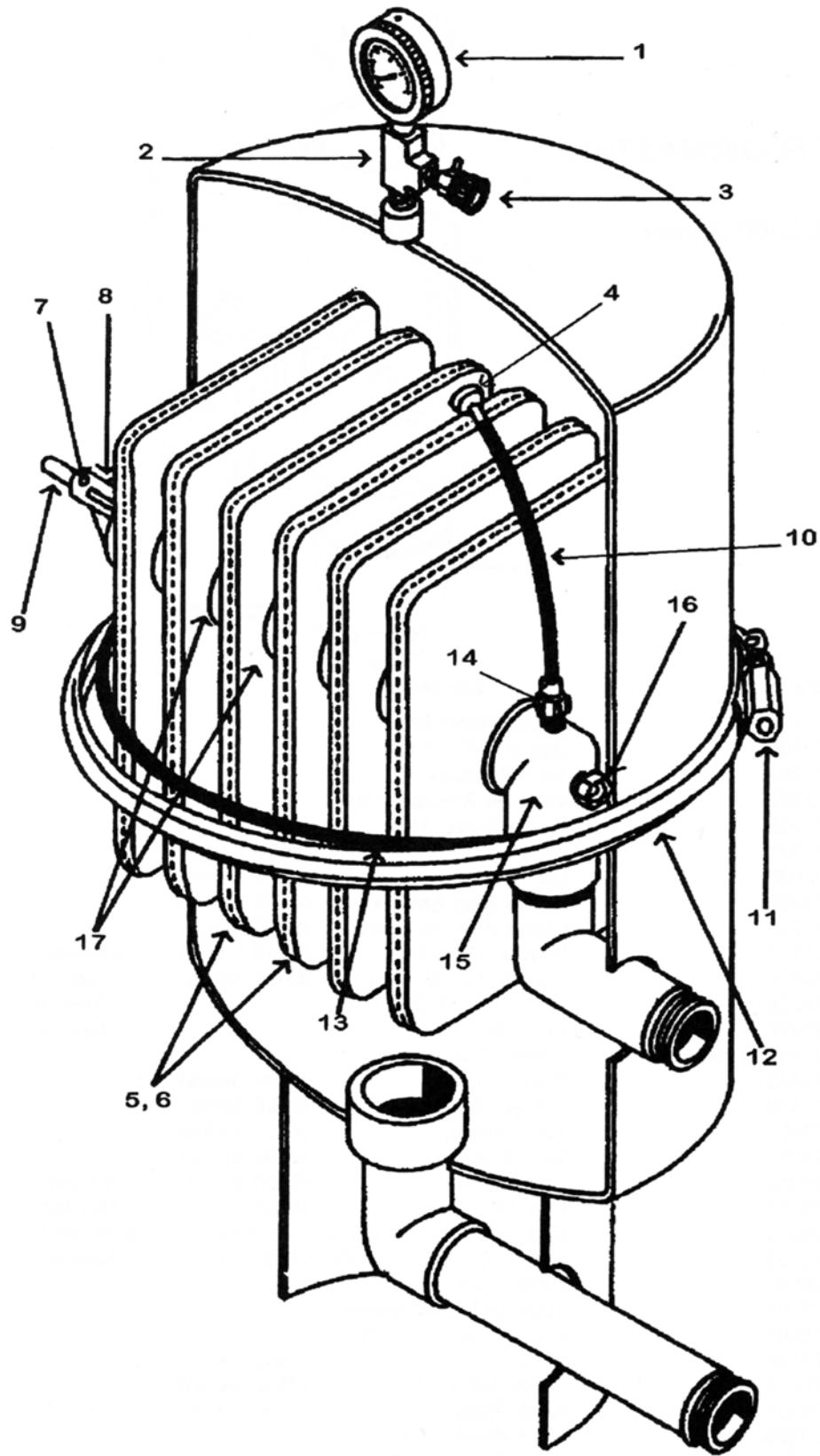

ANTHONY APPOLLO FILTER
Models VA-38, VA-52 (1-1/2") & VA-52 (2")

KEY	MFG. NO.	DESCRIPTION	ITEM NO.
1	-----	Pressure Gauge	H7000
2	-----	Brass Threaded Tee, 1/4"	V5210
3	V34-155	Bleeder Valve, 1/4"	V4652
4	-----	Air Relief Strainer, 1/4"	H4052
5	V34-129	Large Grid 17-1/2" x 24"	H3100
6	V34-128	Small Grid 13-1/2" x 24"	H3099
7	V34-123	End Bell Set Screw S.S.	Z7002
8	V34-122	End Bell w/ Set Screw	Z7001
9a	V34-125	Filter Shaft 17-1/4"	Z7003
9b	V34-126	Filter Shaft 19-3/4"	Z7004
10	-----	Tubing 1/4" O.D x 14"	C1102
11	V34-151	Tank Clamp Nut N/S "Brass"	Z7009
12a	V34-132	18" Tank Clamp	Z7007
12b	V34-133	20" Tank Clamp	Z7008
13a	V34-154	18" Tank O-Ring	H3063
13b	V34-139	20" Tank O-Ring	H3064
14	-----	Poly Fitting, 1/4"	C1090
15a	V34-130	1-1/2" Collection Elbow	Z7005
15b	V34-131	2" Collection Elbow	Z7006
16	V34-121	Insert Nut, Brass	Z7000
17	V34-149	Spacers (1" Wide)	Z7024
17	V34-150	Spacers (1-1/2" Wide)	Z7027

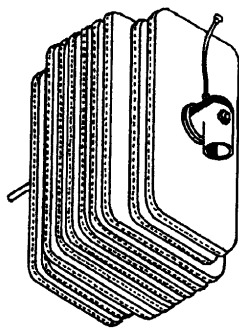

Complete Grid Assemblies

VA38-1.5	Complete Grid Assy. 38 sq. ft. 1-1/2"	Z7028
VA52-1.5	Complete Grid Assy. 52 sq. ft. 1-1/2"	Z7026
VA52-2	Complete Grid Assy. 52 sq. ft. 2"	Z7025

Hayward Pro-Grid DE Filter Parts

Complete Product on
Page 115

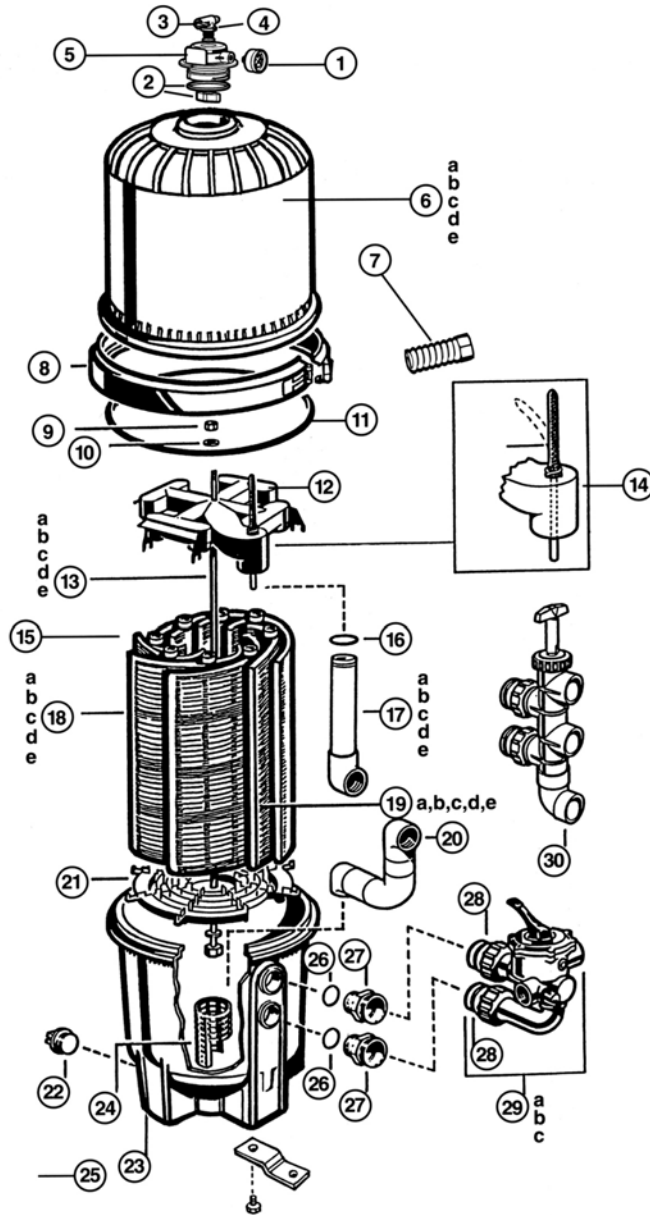

- | | | |
|----|--------------|---|
| 1 | ECX2712B1 | Pressure Guage |
| 2 | DEX2420Z8A | O-Ring Kit (set of 2) |
| 3 | CCX1000N | Manual Air Relief Valve Nut |
| 4 | CCX1000V | Manual Air Relief Valve |
| 5 | DEX2420MAR | Manual Air Relief Assembly |
| 6a | DEX2420BT | Filter Head |
| 6b | DEX3620BT | Filter Head |
| 6c | DEX4820BT | Filter Head |
| 6d | DEX6020BT | Filter Head |
| 6e | DEX7220BT | Filter Head |
| 7 | DEX2420J1KIT | Clamp Spring Assembly Replacement Kit
(washer w/small hole, spring, washer w/
large hole, brass sleeve nut) |

H6092

Hayward Pro-Grid DE Filter Parts Cont'd.

8	DEX2420J1	Clamp Assembly w/ Spring Assembly	
9	ECX176865	Retainer Nut, 5/16" - 18	H6293
10	ECX1108A	Washer, 5/16"	
11	DEX2400K	Filter Tank O-Ring	H6093
12	DEX2400C	Top Collector Manifold	H6059
		w/ Flex Air Relief Assembly	
13a	DEX2400R	Retaining Rod	
13b	DEX3600R	Retaining Rod	H6239
13c	DEX4800	Retaining Rod	H6057
13d	DEX6000R	Retaining Rod	
13e	DEX7200R	Retaining Rod	
14	DEX2400CR	Flex Air Relief Assembly	H6121
15a	DEX2420DC	Filter Element Cluster Assembly elements, collector, locator, etc.	
15b	DEX3600DC	Filter Element Cluster Assembly	H6111
15c	DEX4800DC	Filter Element Cluster Assembly	H6112
15d	DEX6000DC	Filter Element Cluster Assembly	H6138
15e	DEX7200DC	Filter Element Cluster Assembly	
16	DEX2400Z5	Outlet Elbow O-Ring	H6094
17a	DEX2420EA	Outlet Elbow Assembly w/ O-Ring	
17b	DEX3620EA	Outlet Elbow Assembly w/ O-Ring	
17c	DEX4820EA	Outlet Elbow Assembly w/ O-Ring	
17d	DEX6020EA	Outlet Elbow Assembly w/ O-Ring	
17e	DEX7220EA	Outlet Elbow Assembly w/ O-Ring	
18a	DEX2400DA	Filter Element	H4400
18b	DEX3600DA	Filter Element	H4401
18c	DEX4800DA	Filter Element	H4402
18d	DEX6000DA	Filter Element	H4403
18e	DEX7200DA	Filter Element	H4404
19a	DEX2400DS	Filter Element, Short	H4405
19b	DEX3600DS	Filter Element, Short	H4406
19c	DEX4800DS	Filter Element, Short	H4407
19d	DEX6000DS	Filter Element, Short	H4408
19e	DEX7200DS	Filter Element, Short	H4409
20	DEX2420GA	Inlet Elbow	
21	DEX2400H	Filter Element Locator	H6107
22	SP1022C	Drain Plug 1 1/2" , w/ O-Ring	V5029
3	DEX2420AT	Filter Body - Taupe	*
24	DEX2420T	Element Spacer (DE2420 ONLY)	*
25	DEX2420DCKIT	Strap Kit	*
26	SX200Z4	Bulkhead O-Ring	*
27	DEX2420F	Bulkhead O-Ring	*
28	SX200Z4	O-Ring	H6694
29a	SP0740DE	Selecta-Flo Valve Assembly - 2" SKT	V4127
29b	SP0710XR50	Vari-Flo Valve Assembly - 1 1/2" NPT	H6070
29c	SP0715XR50	Vari-Flo Valve Assembly - 2" NPT	H6071
30	SP0410X502S	Slide Valve Assembly - 2" SKT	H6073

* Non-Stocked Item

JACUZZI EARTHWORKS D.E. FILTERS
EW 75, EW 100, EW 125 & EW 150
(Parts on Next Page)

Complete Product on
Page 114

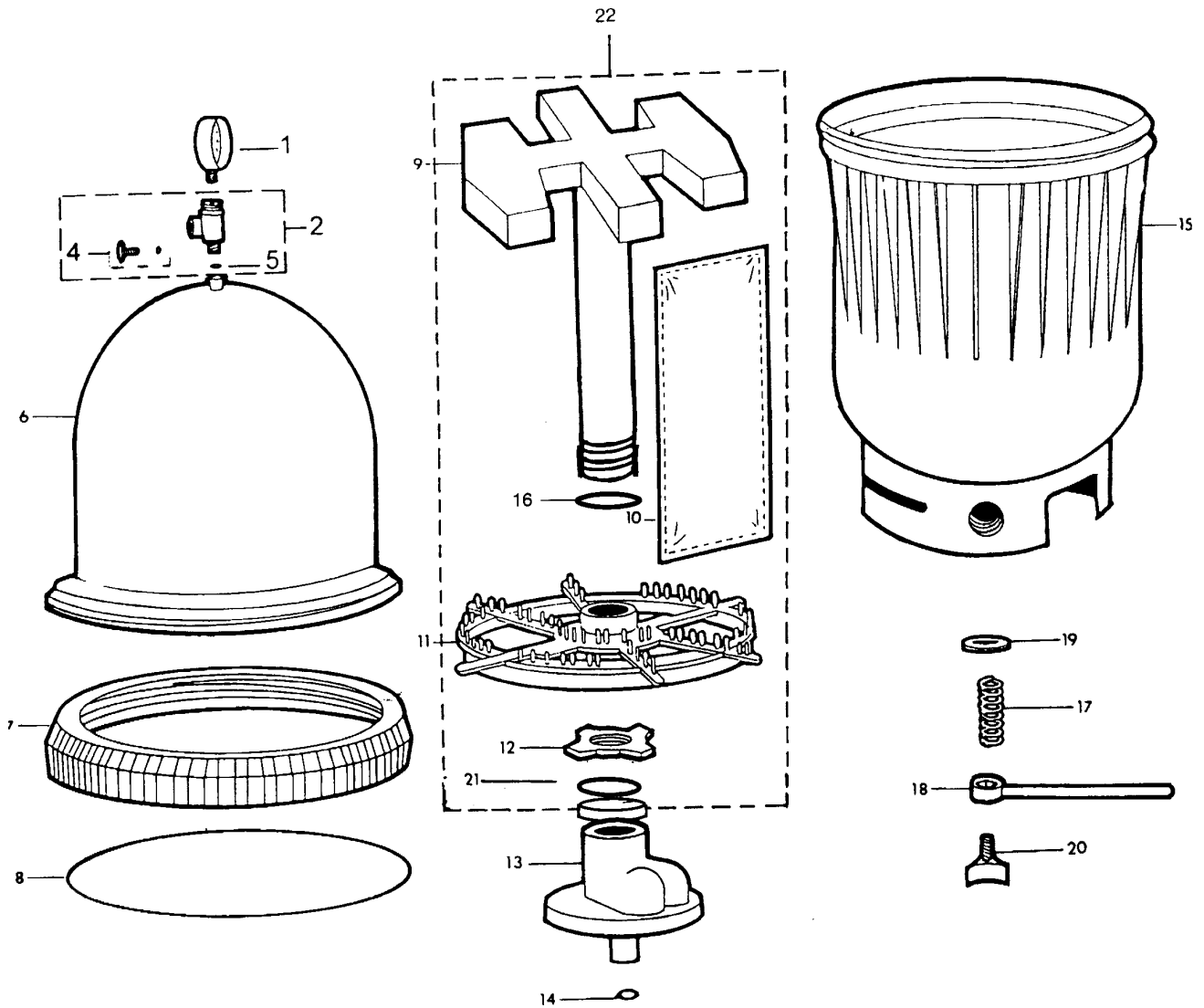

"The Most Trusted Name In Water"™

JACUZZI EARTHWORKS D.E. FILTERS
EW 75, EW 100, EW 125 & EW 150

KEY	MFG NO.	DESCRIPTION	ITEM NO.
1	9193-4158-R	Pressure Gauge, 0-60 psi	H8368
1	-----	Generic Pressure Gauge, Bottom Mount, Plastic	H7000
1	-----	Generic Pressure Gauge, Bottom Mount, Metal	H7003
2	42-2972-00-R	Air Bleeder Tee Assy, 1/4" - PVC (Includes: 4 & 5)	H8111
4	39-2547-01-R	Air Bleeder Valve Knob	H8193
5	47-0112-00-R	O-Ring, 1/2" x 11/16" x 3/32"	H8181
6	42-2930-01-R	Filter Top 40 sq ft (EW 75)	H8112
6	42-2931-00-R	Filter Top 50 sq ft (EW 100)	H8113
6	42-2932-09-R	Filter Top 60 sq ft (EW 125)	H8114
6	42-2933-08-R	Filter Top 70 sq ft (EW 150)	H8116
7	42-2935-06-R	Nut, Earthworks Filter - Aluminum	H8117
8	47-0569-99-R	Tank O-Ring, Earthworks Filter - 20"	H8118
9	42-3524-01-R	Manifold Assembly with #16 O-Ring (EW 75)	H8119
9	42-3525-00-R	Manifold Assembly with #16 O-Ring (EW 100)	H8121
9	42-3526-09-R	Manifold Assembly with #16 O-Ring (EW 125)	H8122
9	42-3527-08-R	Manifold Assembly with #16 O-Ring (EW 150)	H8123
10	42-2121-18-R	(EW 75) Element 10" x 18" (4 per unit)	H8124
	42-2123-16-R	(EW 75) Element 8-1/2" x 18" (8 per unit)	H8125
	42-2125-14-R	(EW 75) Element 7" x 18" (6 per unit)	H8126
10	42-2950-06-R	(EW 100) Element 10" x 24" (4 per unit)	H8127
	42-2951-05-R	(EW 100) Element 8-1/2" x 24" (8 per unit)	H8128
	42-2952-04-R	(EW 100) Element 7" x 24" (6 per unit)	H8129
10	42-2953-03-R	(EW 125) Element 10" x 30" (4 per unit)	H8130
	42-2954-02-R	(EW 125) Element 8-1/2" x 30" (8 per unit)	H8131
	42-2955-01-R	(EW 125) Element 7" x 30" (6 per unit)	H8132
10	42-2956-00-R	(EW 150) Element 10" x 36" (4 per unit)	H8133
	42-2957-09-R	(EW 150) Element 8-1/2" x 36" (8 per unit)	H8134
	42-2958-08-R	(EW 150) Element 7" x 36" (6 per unit)	H8135
11	85-5400-03-R	Element Support Plate - ABS	H8136
12	14-4248-08-R	Retainer Ring for Earthworks Filter	H8137
13	42-2937-04-R	Dial Valve Assembly for Earthworks Filter	H8139
14	47-0212-66-R	O-Ring	H8149
15	42-2934-07-R	Filter Bottom	H9220
16	14-0139-09-R	O-Ring	H8101
17	16-1091-00-R	Compression Spring, Stainless Steel	H8151
18	22-5574-09-R	DV Handle - Aluminum / Bronze	H8152
19	14-1984-02-R	Washer 1-1/32" x 1-1/2" x .045	H8153
20	14-4262-09-R	DV Thumb Screw for Earthworks Filter	H8154
21	14-4308-05-R	Foam Washer (Discontinued 9/98)	H8155
22	42-3584-08	(EW 75) Manifold Grid Assembly (Items 9 thru 12)	H8156
22	42-3585-07	(EW 100) Manifold Grid Assembly (Items 9 thru 12)	H8157
22	42-3586-06	(EW 125) Manifold Grid Assembly (Items 9 thru 12)	H8158
22	42-3587-05	(EW 150) Manifold Grid Assembly (Items 9 thru 12)	H8159

Jandy DEL Series

Complete Product on
Page 114

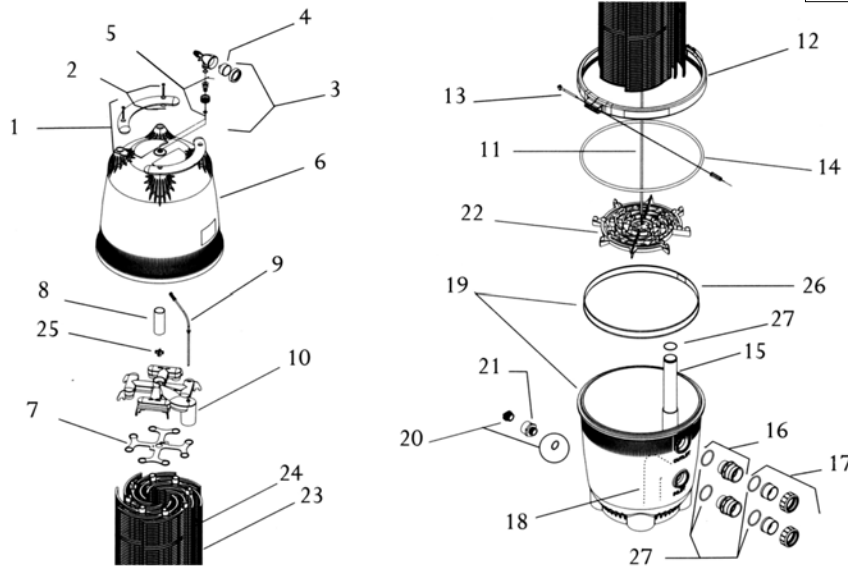

1	R0357100	Handle Assembly w/Hardware (set of 2)	H2100
2	R0359900	Handle Hardware (set of 4)	
3	R0357200	Gauge / Air Release Assembly	K2550
4	R0359600	Pressure Gauge	
5	R0552000	Tank Adapter w/O-ring	H2104
6	R0357300	Tank Top, DEL60	
	R0554700	Tank Top, DEL48	
7	R0359700	Top Spacer for DE Grids	H2134
8	R0405100	Top Spacer Collar	H2135
9	R0358700	Breather Tube Assembly	H2109
10	R0359000	DE Manifold Assembly	H2136
11	R0359300	Tie Rod w/ Knob & Lock Nuts, DEL60	H2138
	R0554800	Tie Rod w/ Knob & Lock Nuts, DEL48	H2140
12	R0357400	Tank Clamp Ring w/ Knob Assembly	H2113
13	R0357500	Clamp Ring Knob Assembly	
14	R0357800	w/ Threaded Rod and Retainer	
15	R0358100	Tank O-ring	H2116
	R0555100	Outlet Tube / Elbow Assembly	
		w/ O-rings, DEL60	
		Outlet Tube / Elbow Assembly	
		w/ O-rings, DEL48	
16	R0358200	Bulkhead Assembly w/ O-ring	H2122
17	R0328300	Coupling Nuts w/ Flange	J6372
		and O-ring (set of 2)	
18	R0358400	Inlet Elbow w/ O-ring	
19	R0358600	Tank Bottom w/ Retaining Ring and Drain Plug	
20	R0358800	Drain Plug w/ O-ring	H2130
21	R0395500	Large Tank Drain Adapter w/ O-ring	H2458
22	R0359500	DE Grid Support	H2142
23	R0359100	DE Single Grid, Full Size, DEL60 (7 req'd)	H4403
	R0555000	DE Single Grid, Full Size, DEL48 (7 req'd)	H4402
24	R0359200	DE Single Grid, Short Span, DEL60 (1 req'd)	H4408
	R0554900	DE Single Grid, Short Span, DEL48 (1 req'd)	H4407
25	R0359400	Tie Rod Knob	H2144
26	R0405200	Large Tank Retaining Ring	H2145
27	R0442500	"O" ring Kit, outlet tube, bulkhead assembly	
	R0358000	Large Tank O-ring Replacement Kit (not shown)	
	H0238800	Installation / Operation Manual	
	R0442600	Complete Set of Filter Grids for DEL 60	H3097
		(7 full-size, 1 short span)	
	R0442700	Complete Set of Filter Grids for DEL 48	H3096
		(7 full-size, 1 short span)	
	R0443700	Gauge Adapter Kit (not shown)	
		(1 brass pump adapter, and 1 thermoplastic filter adapter)	

PENTAIR (PAC-FAB) FNS PLUS FILTERS***Reinforced Polypropylene Material Tank***

KEY	MFG NO.	DESCRIPTION	ITEM NO.
1	53003201	Pressure Gauge	H3500
1	-----	Generic Pressure Gauge	H7003
1	-----	Generic Pressure Gauge	H7010
2	98209800	Air Relief Valve Assembly - Manual	H3708
3	98201200	Hose and Retainer Clip for Air Relief Valve <i>(N/A when out)</i>	H3565
4	58001100	Nut, Knurled Brass	H3712
5	59000800	Tie Rod, 24 sq. ft. Filter	H3528
5	59001500	Tie Rod, 36 sq. ft. Filter	H3529
5	59002100	Tie Rod, 48 sq. ft. Filter	H3530
5	59002700	Tie Rod, 60 sq. ft. Filter	H3531
6	59023700	Manifold, Top w/ Air Bleed	H3695
7	59023600	Internal Air Bleed Assembly	H3696
8	98725800	Template, Filter	H3555
9	59001100	Grid, Large 12", 24 sq. ft. Filter <i>(Generic H4400)</i>	H3534
9	59001800	Grid, Large 18", 36 sq. ft. Filter <i>(Generic H4401)</i>	H3535
9	59002400	Grid, Large 24", 48 sq. ft. Filter <i>(Generic H4402)</i>	H3536
9	59003000	Grid, Large 30", 60 sq. ft. Filter <i>(Generic H4403)</i>	H3537
10	59001000	Grid, Small 12", 24 sq. ft. Filter <i>(Generic H4405)</i>	H3541
10	59001700	Grid, Small 18", 36 sq. ft. Filter <i>(Generic H4406)</i>	H3542
10	59002300	Grid, Small 24", 48 sq. ft. Filter <i>(Generic H4407)</i>	H3543
10	59002900	Grid, Small 30", 60 sq. ft. Filter <i>(Generic H4408)</i>	H3544
11	59023800	Complete Grid Assembly for 24 sq. ft. Filter	H3700
11	59023500	Complete Grid Assembly for 36 sq. ft. Filter	H3701
11	59023400	Complete Grid Assembly for 48 sq. ft. Filter	H3702
11	59023300	Complete Grid Assembly for 60 sq. ft. Filter	H3703
12	98211400	Nut, 1/4-20, Plated Brass	H8916
13	59000500	Spider, Grid Locator	H3539
14	58001000	Nut, Lock, Hex, Nylon	H3635
15	39010200	O-Ring, RPM Tank Clamp	H3590
16	190034	Clamp, Kit	H3589
17	53006300	Washer, .325 I.D. for Filter Clamp	H3657
18	53108900	Spring/Barrel Nut Assembly	H3501
19	190034	Assy., Standpipe, Outlet, 24 sq. ft. Filter	H3720
19	190035	Assy., Standpipe, Outlet, 36 sq. ft. Filter	H3721
19	190036	Assy., Standpipe, Outlet, 48 sq. ft. Filter	H3722
19	190037	Assy., Standpipe, Outlet, 60 sq. ft. Filter	H3723
20	86006900	O-Ring, Bulkhead	H3637
21	271096	Bulkhead Union (set)	H4040
22	190043	Assembly, Pipe, Inlet	H3558
23	51005000	O-Ring for Drain Plug	H8931
24	86202000	Plug, 1-1/2" Drain, w/O-Ring	H3711

PENTAIR (PAC-FAB) FNS PLUS FILTERS
Reinforced polypropylene Material Tank

Complete Product on
 Page 116

KEY	MFG NO.	DESCRIPTION	ITEM NO.
25	170015	Tank Bottom, Assy., 24 sq. ft. Filter	H3730
25	170016	Tank Bottom, Assy., 36 sq. ft. Filter	H3731
25	170017	Tank Bottom, Assy., 48 sq. ft. Filter	H3732
25	170018	Tank Bottom, Assy., 60 sq. ft. Filter	H3733
26	170019	Tank Lid, 24 sq. ft. Filter	H3734
26	170020	Tank Lid, 36 sq. ft. Filter	H3735
26	170021	Tank Lid, 48 sq. ft. Filter	H3736
26	170022	Tank Lid, 60 sq. ft. Filter	H3737

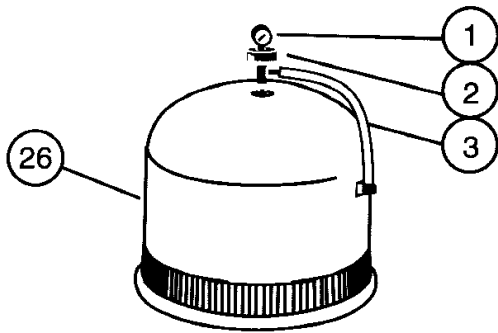

*FNS Plus 24, 36,
 48 & 60 Sq. Ft. Series*

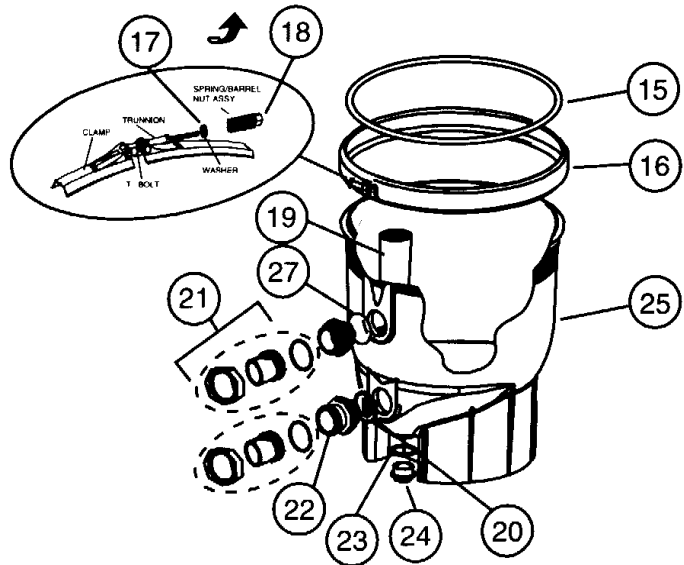
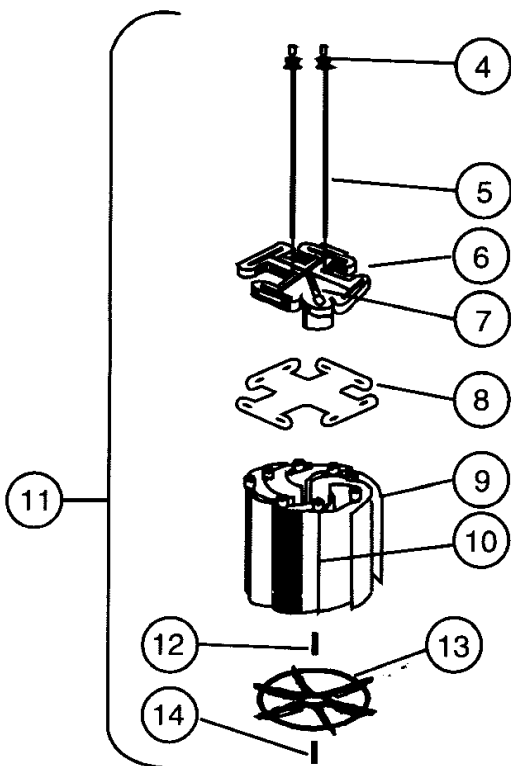

**purex
 triton**

PENTAIR (PAC-FAB) NAUTILUS FNS D.E. FILTERS
Fiberglass Filter Tank

Complete Product on
 Page 116

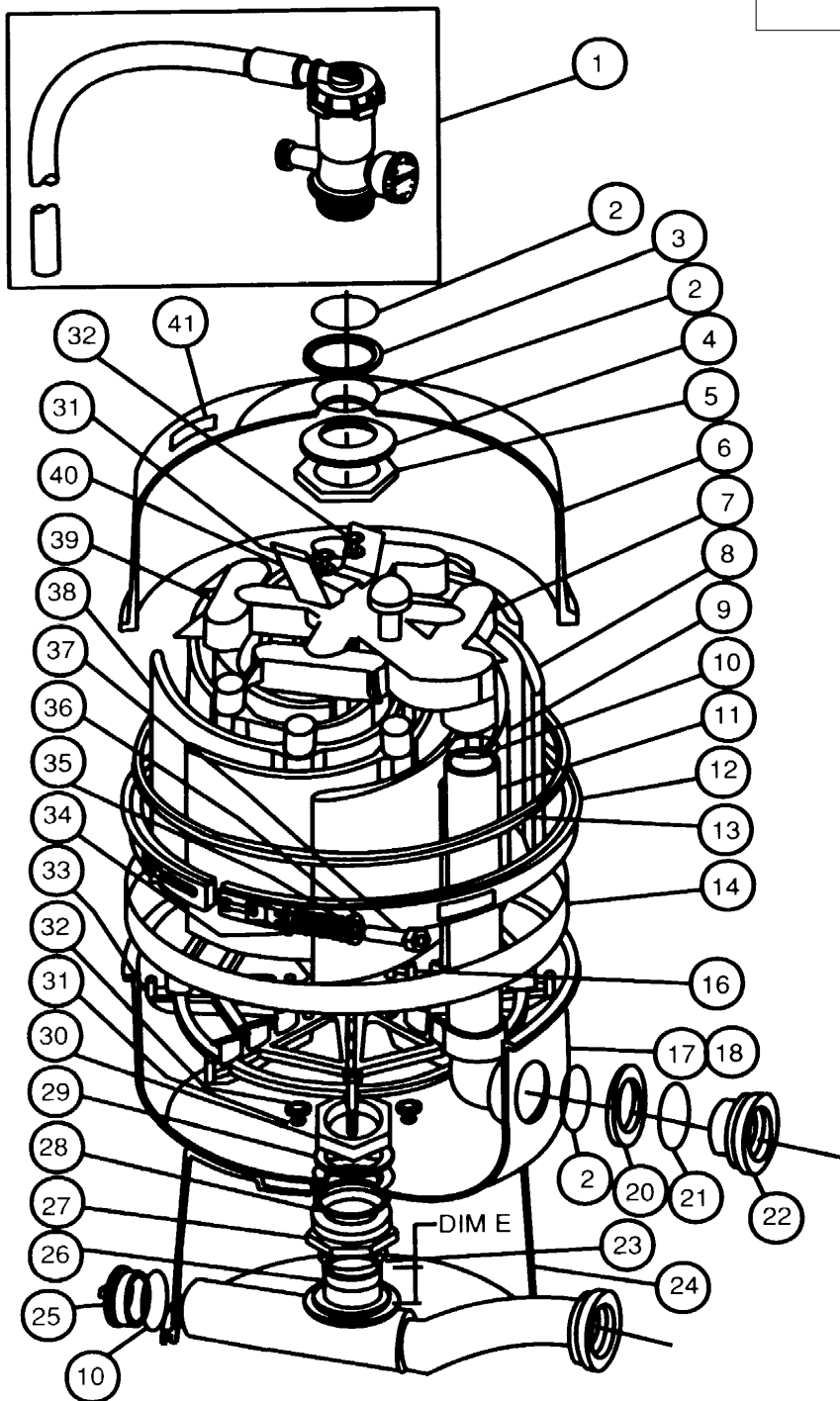

FNS-24
FNS-36
FNS-48
FNS-60

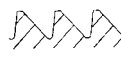

 Detail A, (after 12/1/91)
 6 in. br. Thread.

 Detail B, (before 12/1/91)
 6 in. "V" Thread.

PENTAIR (PAC-FAB) NAUTILUS FNS D.E. FILTER
FNS-24, FNS-36, FNS-48 & FNS-60 Fiberglass Tank

KEY	MFG NO.	DESCRIPTION	ITEM NO.
1	261003	Automatic Air Relief Assembly <i>(No longer available)</i>	H4316
1	273550	Manual Air Relief	H4316
2	154492	O-Ring for 2" Bulkhead <i>(3 needed)</i>	H4246
3	273502	Spacer - Top Black	H4321
4	273505	Spacer	H4419
5	154412	Bulkhead Nut	H4230
6	195950	** Tan Tank Top with Air Relief Valve (FNS-24 & FNS-36)	H4451
6	195951	** Tan Tank Top with Air Relief Valve (FNS-48)	H4452
6	195952	** Tan Tank Top with Air Relief Valve (FNS-60)	H4453
6	195947	** Black Tank Top with Air Relief Valve (FNS-24 & FNS-36)	H4454
6	195948	** Black Tank Top with Air Relief Valve (FNS-48)	H4455
6	195949	** Black Tank Top with Air Relief Valve (FNS-60)	H4456
6	195941	** Black Tank Top with 2-3/8" Hole (FNS-24 & FNS-36)	H4457
6	195942	** Black Tank Top with 2-3/8" Hole (FNS-48)	H4458
6	195943	** Black Tank Top with 2-3/8" Hole (FNS-60)	H4459
7	192173	Manifold Grid (with Extension)	H4431
8	59001100	Full Element Grid - 12" (FNS-24) <i>(7 needed)</i>	H3130
8	59001800	Full Element Grid - 18" (FNS-36) <i>(7 needed)</i>	H3131
8	59002400	Full Element Grid - 24" (FNS-48) <i>(7 needed)</i>	H3132
8	59003000	Full Element Grid - 30" (FNS-60) <i>(7 needed)</i>	H3133
9	59001000	Partial Element Grid - 12" (FNS-24) <i>(1 needed)</i>	H3147
9	59001700	Partial Element Grid - 18" (FNS-36) <i>(1 needed)</i>	H3148
9	59002300	Partial Element Grid - 24" (FNS-48) <i>(1 needed)</i>	H3149
9	59002900	Partial Element Grid - 30" (FNS-60) <i>(1 needed)</i>	H3150
10	192323	O-Ring for Upper Piping Assembly	H3142
11	195213	Upper Piping Assembly (FNS-24)	H4432
11	195214	Upper Piping Assembly (FNS-36)	H4433
11	195215	Upper Piping Assembly (FNS-48)	H4434
11	195216	Upper Piping Assembly (FNS-60)	H4435
12	195351	+ Band Assembly - Complete	H4471
13	195008	Tank O-Ring	H3189
14	195337	*** Retainer - Tank Seal 15/16" Tall	H4460
16	192182	Rod, 5/16" x 15-1/2" Manifold Retainer (FNS-24) <i>(2 needed)</i>	H3126
16	192183	Rod, 5/16" x 21-1/2" Manifold Retainer (FNS-36) <i>(2 needed)</i>	H3127
16	192184	Rod, 5/16" x 27-1/2" Manifold Retainer (FNS-48) <i>(2 needed)</i>	H3128
16	192185	Rod, 5/16" x 33-1/2" Manifold Retainer (FNS-60) <i>(2 needed)</i>	H3129
16A	192140	Rod, 5/16" x 13" Long (FNS-24)	H4461
16A	192141	Rod, 5/16" x 19" Long (FNS-36)	H4462
17	195934	Black Tank Bottom with Buttress Thread (FNS-24)	H4437
17	195935	Black Tank Bottom with Buttress Thread (FNS-36 thru FNS-60)	H4438
17	195930	Tan Tank Bottom with Buttress Thread (FNS-24)	H4439
17	195931	Tan Tank Bottom with Buttress Thread (FNS-36 thru FNS-60)	H4440
18	195400	% Black Tank Bottom, Foot & Piping (FNS-24)	H4463
18	195401	% Black Tank Bottom, Foot & Piping (FNS-36)	H4464
18	195402	% Black Tank Bottom, Foot & Piping (FNS-48)	H4465
18	195403	% Black Tank Bottom, Foot & Piping (FNS-60)	H4466
20	194893	Spacer - 2" External	H3160
21	192320	O-Ring, Bulkhead	H3141
22	194801	Bulkhead Fitting - 2" with Groove	H4334
23	274494	O-Ring for Valve Adaptor	H3371
24	195153	Foot	H4443
25	195829	Plug, 2" NPSM	H4398
26	195308	@ Lower Pipe Assembly <i>(Dimension E = 1-5/8")</i>	H4446
27	195221	# !! Adaptor 6" FNS Buttress Thread <i>(Use w/19-5308)</i>	H4448
28	274494	O-Ring Adaptor, 6" FNS	H3371
29	195004	Washer, Polyethylene	H3198

(Continued on Next Page)

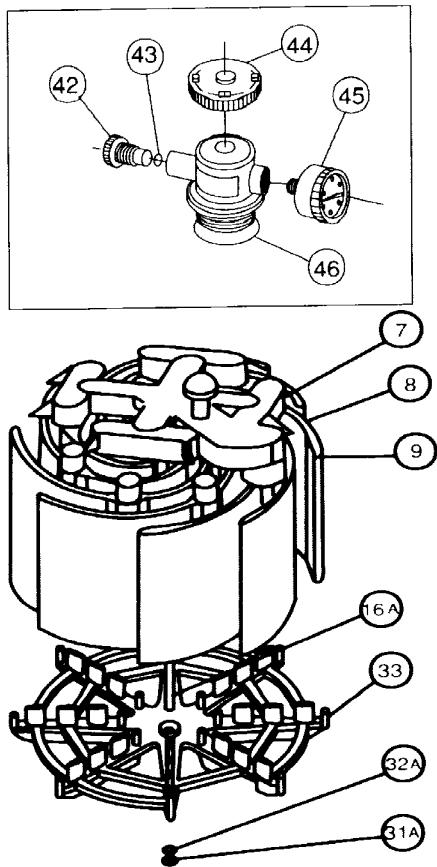

ALTERNATE GRID ASSEMBLY
USING SINGLE ROD - FN534.36

PRODUCT CHANGE HISTORY

- + + Filters manufactured before July 1, 1993 contain a bracket support (item 40) which prevented the grid assy. from being lifted off the standpipe under certain operating conditions. Current models have increased engagement between the manifold and the standpipe so that item 40 is no longer required.
- + Filters manufactured before March 1, 1993 contain a different clamp band assy. (item 12). The correct P/N for these units is 19-5038. Filters manufactured before Sept. 1, 1992 contain a different (Non-spring design). Clamp components such as nuts, washers or bolts are no longer available for these non-spring design clamps. Do not attempt to interchange components between spring design and non-spring design clamps.
- *** Filters manufactured before March 1, 1993 contain a different retainer (item 14) which is 5/8 in. tall. For replacement, order P/N 19-5073.
- ** Filters manufactured before March 1, 1993 contain a different tank top assy. which is no longer available. Replacement of tank top assy. may be accomplished by ordering the following current production items: Tank top assy. (item 6), retainer (item 14) and band assy. (item 12).
- @ Filters manufactured before Oct. 1, 1992 utilize a different lower piping assy. P/N 19-5107. Lower piping P/N 19-5107 fits 6 in. adaptors P/N 19-5219 and P/N 19-5225 only. Dimension "E" for P/N 19-5107 is 2 1/2 in.
- * Filtered manufactured between Nov. 1, 1991 and Oct. 1, 1992 utilize a different 6 in. btm. adaptor P/N 19-5225. Adaptor P/N 19-5225 fits lower piping P/N 19-5107 only. Adaptor P/N 19-5225 may be placed with current design closure only if current lower piping P/N 19-5308 is used.
- !! Filters manufactured before Nov. 1, 1991 utilize a different 6 in. btm. adaptor P/N 19-5219. This item has a different thread design and will not interchange with adaptor P/N 19-5221 or P/N 19-5225. Adaptor P/N 19-5219 fits lower piping P/N 19-5107 only.
- # Filters manufactured between Nov. 1, 1991 and Oct. 1, 1992 utilize a different 6 in. btm. adaptor P/N 19-5225. Adaptor P/N 19-5225 fits lower piping P/N 19-5107 only. Adaptor P/N 19-5225 may be replaced with current design closure only if current low piping P/N 19-5308 is used.
- % Filters manufactured before Nov. 1, 1991 utilize a different tank btm. with "V" thread btm. opening which is no longer available. These btm.s may be replaced with item 18 tank btm. with foot and lower piping.

PENTAIR (PAC-FAB) NAUTILUS FNS D.E. FILTERS (Cont.)
Models FNS-24, FNS-36, FNS-48 & FNS-60 Fiberglass Tank

KEY	MFG NO.	DESCRIPTION	ITEM NO.
30	154412	Locknut, 2" Internal	H4230
31	192013	Nut, 5/16" - 16, S.S.	H3102
31A	192013	Nut, 5/16" - 16, S.S.	H3102
32	174955	Lock Washer, 5/16", S.S.	H4450
32A	174955	Lock Washer, 5/16", S.S.	H4450
33	192194	Retainer Grid - Bottom	H3135
34	195610	+ Washer, Small ID	H4551
35	195612	+ Spring	H4552
36	195611	+ Washer, Large ID	H4553
37	194997	+ Nut, Machined	H4554
38	195182	Complete Grid Assembly (FNS-24) <i>Items #7 - 9, 16, 31 - 33 & 39</i>	H4555
38	195183	Complete Grid Assembly (FNS-36) " " " "	H4556
38	195086	Complete Grid Assembly (FNS-48) " " " "	H4557
38	195070	Complete Grid Assembly (FNS-60) " " " "	H3282
39	172855	Air Vent Strainer - 3/4" (Filters Built After 12/1/91)	H4054
40	174755	++ Bracket Support	H4559
42	273512	Bleeder Screw	H4222
43	273513	O-Ring for Bleeder	H4223
44	273501	Cap, Bleeder Assembly, Obsolete	H4273
45	155050	Pressure Gauge - Back Mount	H4300
45	-----	Generic Pressure Gauge - Back Mount	H7010
46	154492	O-Ring, Bleeder Assembly	
H4246			
---	197082	Bulkhead Wrench, Bottom - 2" (old #15-1603)	H4308

PENTAIR (PAC-FAB) STAR D.E. FILTERS
ST-35, ST-50 & ST-80

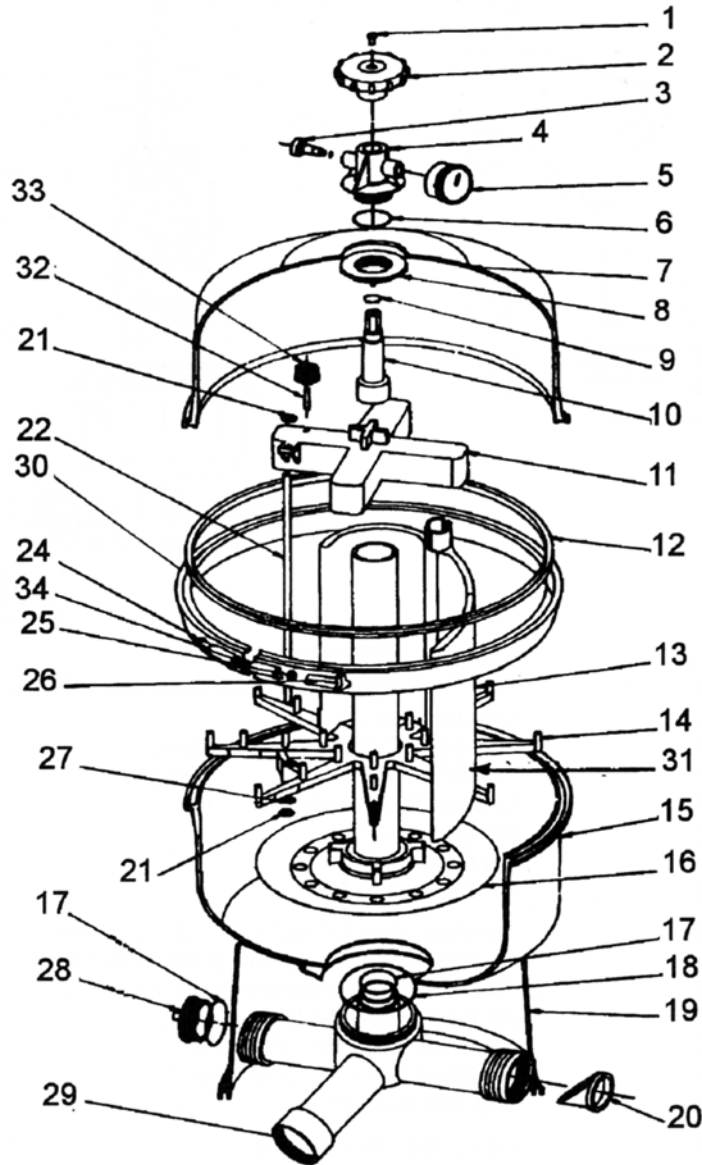

KEY	MFG NO.	DESCRIPTION	ITEM NO.
1	552472	Screw, Flathead #12 x 1"	H3253
2	191472	Knob, Engagement Shaft	H3254
3	272515	Air Bleeder with O-Ring	H3255
4	191475	Adaptor for Tank Top	H3256
5	155050	Pressure Gauge - Back Mount	H4300
5	-----	Pressure Gauge - Back Mount, Generic	H7010
6	155064	O-Ring, 1-7/8" x 2—1/8" x 1/8"	H4305
7	191954	Tan Tank Top, w/Knob (ST-35)	H3290
7	191501	Tan Tank Top, w/Knob (ST-40 & ST-50)	H3292
7	750012	Black Tank Top, w/Knob (ST-35)	H3293
7	191500	Black Tank Top, w/Knob (ST-40 & ST-50)	H3294
7	191509	Black Tank Top, w/Knob (ST-80)	H3679
8	191478	Nut, Buttress Threads, 1-7/8"	H3257

PENTAIR (PAC-FAB) STAR D.E. FILTERS
ST-35, ST-50 & ST-80

KEY	MFG NO.	DESCRIPTION	ITEM NO.
9	191479	O-Ring, 7/8" x 1-1/8" x 1/8"	H3261
10	191955	Engagement Shaft (ST-35)	H3295
10	191480	Engagement Shaft (ST-40 & ST-50)	H3262
11	191950	Manifold Assembly	H3263
12	174704	Tank O-Ring	H5101
13	191321	Grid (ST-35) 4 needed	H3272
13	191322	Grid (ST-40 & ST-50) 4 needed	H3273
13	191510	Grid (ST-80)	H3681
14	191467	Retainer for Grids - Bottom	H3264
15	191422	Tan Tank Bottom (ST-40 & ST-50)	H5145
15	191503	Tan Tank Bottom (ST-35)	H3296
15	191504	Black Tank Bottom (ST-35)	H3297
15	750009	Black Tank Bottom (ST-40 & ST-50)	H5148
15	191511	Black Tank Bottom (ST-80)	H3683
16	191942	Center Pipe w/ Diffuser & O-Ring (ST-35)	H3298
16	191483	Center Pipe w/ Diffuser & O-Ring (ST-40 & ST-50)	H3265
16	191512	Center Pipe w/ Diffuser & O-Ring (ST-80)	H3685
17	191474	O-Ring, 1-3/4" x 2" x 1/8" 2 needed	H3266
18	191424	O-Ring, 3-1/2" x 3-7/8" x 3/16"	H3267
19	191423	Foot - Tank	H5142
20	191437	Check Valve Assembly	H3268
21	272408	Nut, Hex 1/4" - 20 Serrated S.S. 4 needed	H3277
22	191948	Rod, 1/4" x 15" S.S. (ST-35) 2 needed	H3299
22	191430	Rod, 1/4" x 21-1/2" S.S. (ST-40 & ST-50) 2 needed	H3278
22	191513	Rod, 1/4" x 28" (ST-80)	H3687
24	152060	Bolt, 5/16" - 18 x 4-1/4" Carriage	H4207
25	072173	Flat Washer, 5/16" S.S. (Replaces #63-9822)	L1553
26	174882	Knob for Band Assembly	H5138
27	191330	Lock Washer, 1/4" S.S. 2 needed	H3279
28	552417	Plug, 1-1/2" with O-Ring	H5149
29	191469	Bottom Piping Assembly with Check Valve	H5103
30	174880	Band Assembly - Complete (Items #23 thru #26 & #34)	H4315
31	191953	Grid Assembly - Complete (ST-35)	H5108*
31	191486	Grid Assembly - Complete (ST-40 & ST-50)	H3276*
31	191519	Grid Assembly - Complete (ST-80)	H3689
32	191606	Tubing - 1/4"	H3281
33	191329	Air Relief Strainer	H4052
34	175020	Retaining Ring Carriage Bolt	H3283
---	191495	Wrench - Star Center Piping	H5114
---	750016	Piping Assy., Star Systems (incl. piping, parts & o-rings)	H3043

* Grid Assembly - Complete, Consists of Items #11, #13, #14, #21, #22 & #27

Hayward Pro Series S180T, S210T, S220T & S244T	355
Hayward Pro Series S210S, S220S, S224S & 310S	356-357
Pac-Fab Tagelus	358-361
Pac-Fab Triton II	362-363
Pac-Fab Triton C	364-365
Pac-Fab Triton C-3	366-367

HAYWARD PRO SERIES SAND FILTERS

Complete Product on Page 112

S180T
S210T
S220T
S244T

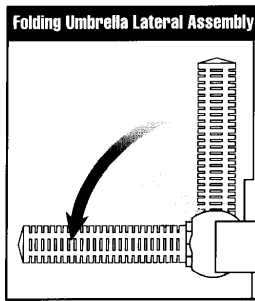
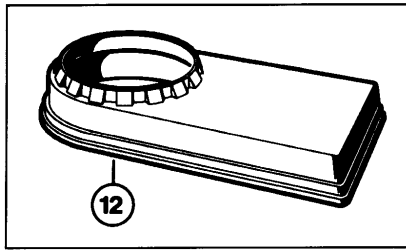
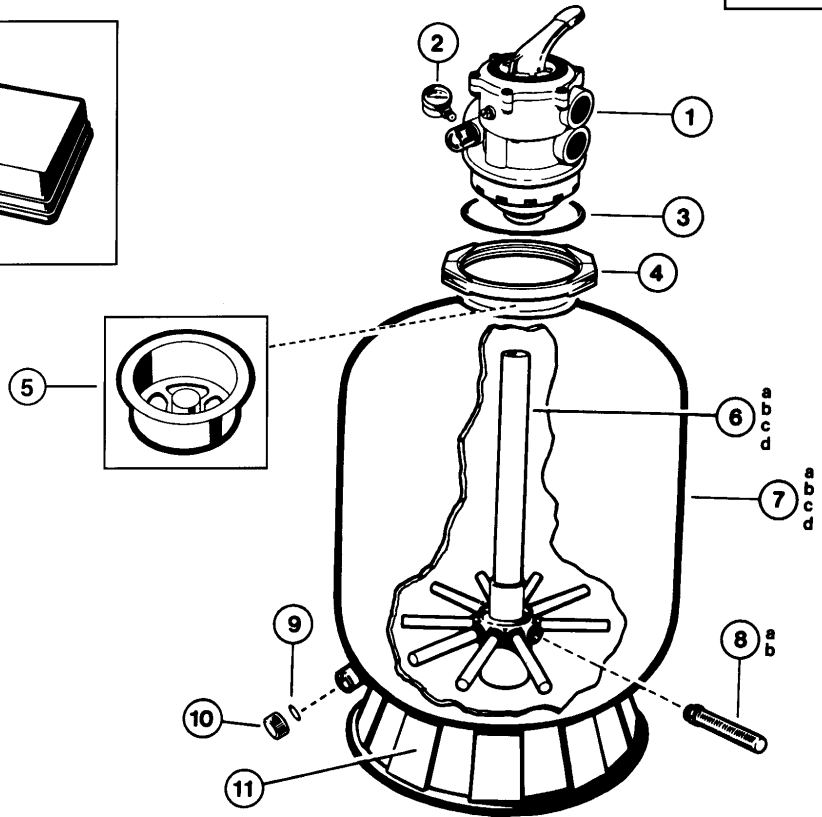

Diagram A



KEY	MFG NO.	DESCRIPTION	ITEM NO.
1	SP0714T	Vari-Flo XL Control Valve - 1-1/2"	H8000
2	ECX270861	Pressure Gauge	H6317
2	-----	Generic Pressure Gauge, Plastic Case, Back Mount	H7000
2	-----	Generic Pressure Gauge, Metal Case, Back Mount	H7003
3	GMX600F	Valve/Tank O-Ring	H8425
4	GMX600NM	Flange Clamp, Noryl	H6613
5	SX202S	Sand Shield (1997-Present)	H6707*
6A	SX180DA	Folding Umbrella Lateral Assembly with Center Pipe (S180T)	H6609
6B	SX210DA	Folding Umbrella Lateral Assembly with Center Pipe (S210T)	H6614
6C	SX220DA	Folding Umbrella Lateral Assembly with Center Pipe (S220T)	H6683
6D	SX244DA	Folding Umbrella Lateral Assembly with Center Pipe (S244T)	H6780
7A	SX180AA2	Filter Tank with Skirt, Drain & Lateral Assembly (S180T)	H6615*
7B	SX210AA1	Filter Tank with Skirt, Drain & Lateral Assembly (S210T)	H6616*
7C	SX220AA1	Filter Tank with Skirt, Drain & Lateral Assembly (S220T)	H6617*
7D	SX244AA1	Filter Tank with Skirt, Drain & Lateral Assembly (S244T)	H6618*
---	SX202P	Lateral Pivot (1996-Present)	H6702*
8A	SX200Q	Lateral (S180T) (10 needed)	H6670
8B	SX240D	Lateral (S210T, S220T & S244T) (10 needed)	H6772
9	SX180G	Gasket	H6610
10	SX180H	Drain Cap	H6611
11	SX200J	Filter Support Stand	H6678
12	SX180K	System Base (S180T Systems)	H6612*

HAYWARD PRO SERIES SAND FILTERS
S210S, S220S, S244S & S310S

KEY	MFG NO.	DESCRIPTION	ITEM NO.
1	SX200G	Manual Air Relief Cap	H6640
2	SX200Z5	O-Ring, 13/16" O.D.	H6642
3	SX244K	Top Closure Dome	H6639
4	GMX600F	Valve/Tank O-Ring	H8425
5A	GMX600NM	Flange Clamp (Dome - Tank) Noryl	H6613
5B	SX310N	Flange Clamp (Dome - Tank) (S310S)	H6600
6A	SX210AA2FW	Filter Tank (S210S after 1997)	H6641*
6B	SX220AA2	Filter Tank (S220S)	OBS
6C	SX244AA2	Filter Tank (S244S 1996 & prior)	OBS
6D	SX244AA2FW	Filter Tank (S244S after 1996)	H6645*
6E	SX310AA2	Filter Tank (S310S 1996 & prior)	H6649*
6F	SX310AA2FW	Filter Tank (S310S after 1996)	H6738*
7	SX244G	Top Diffuser	H6651
8A	SX210CD	Top Elbow Assembly (S210S 1995 & prior)	H6652*
8B	SX244CD1	Top Elbow Assembly (S244S 1995 & prior)	H6654*
8C	SX310CD1	Top Elbow Assembly (S310S 1995 & prior)	H6655
8D	SX210CD1FW	Top Elbow Assembly (S210S after 1996)	H6740
8E	SX244CD1FW	Top Elbow Assembly (S244S after 1996)	H6637*
8F	SX310CD1FW	Top Elbow Assembly (S310S after 1996)	H6656
9A	SX210CD2	Bottom Elbow Assembly (S210S 1995 & prior)	OBS
9B	SX244CD2	Bottom Elbow Assembly (S244S 1995 & prior)	H6661
9C	SX310CD2	Bottom Elbow Assembly (S310S 1995 & prior)	H6663*
9D	SX210CD2FW	Bottom Elbow Assembly (S210 after 1996)	H6691*
9E	SX244CD2FW	Bottom Elbow Assembly (S244S after 1996)	H6692*
9F	SX310CD2FW	Bottom Elbow Assembly (S310S after 1996)	H6698*
10A	SX200Q	Lateral (S210S) (10 needed)	H6670
10B	SX240D	Lateral (S220S & S244S) (10 needed)	H6772
10C	SX310HA	Lateral (S310S)	H6605
11A	SX242MA1	Folding Lateral Holder Assy (S310S after 1997)	H6774*
11B	SX242MA2	Folding Lateral Holder Assy (S220S, S244S after 1999)	H6742*
11C	SX242MA3	Folding Lateral Holder Assy (S310S after 1999)	H6733*
12A	CX3000Z2	Plastic Air Tube (S210S)	H6665
12B	CX1100Z4	Plastic Air Tube (S244S)	H5240*
12C	SX200Z1	Plastic Air Tube (S310S)	H6658
13	SX200Z2	Air Tube Lock Screw	H6660*
14	SX180G	Gasket	H6610
15	SX180H	Drain Cap	H6611
16A	SX200J	Filter Support Stand	H6678
16B	SX310J	Filter Support Stand, Large (S310S)	H6606*
17A	SP0710X62	1-1/2" Vari-Flo Control Valve Assembly with Gauge	H8016
17B	SP0715X62	2" Vari-Flo Control Valve Assembly with Gauge	H8017
18	SX200Z4	O-Ring	H6694
19	ECX270861	Pressure Gauge	H6317
20A	SX220Z3	O-Ring (Large, 1995 & prior, 2 needed)	H6669
20B	SX360Z1	O-Ring	OBS
21	SX360E	O-Ring Spacer (after 1995)	H6703*
22A	DEX360F	Bulkhead Fitting (2 needed)	H6120
22B	SX244P	Bulkhead Fitting (S210S, S244S, S310S, S311S)	H6705*

HAYWARD PRO SERIES SAND FILTERS

S210S, S220S,
S244S & S310S

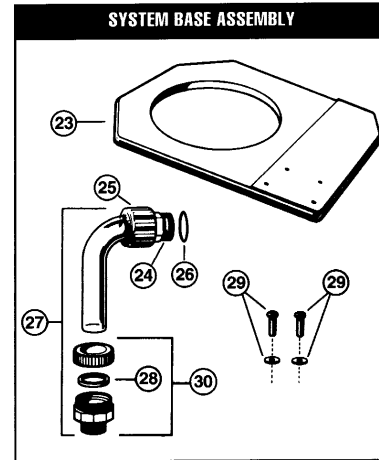
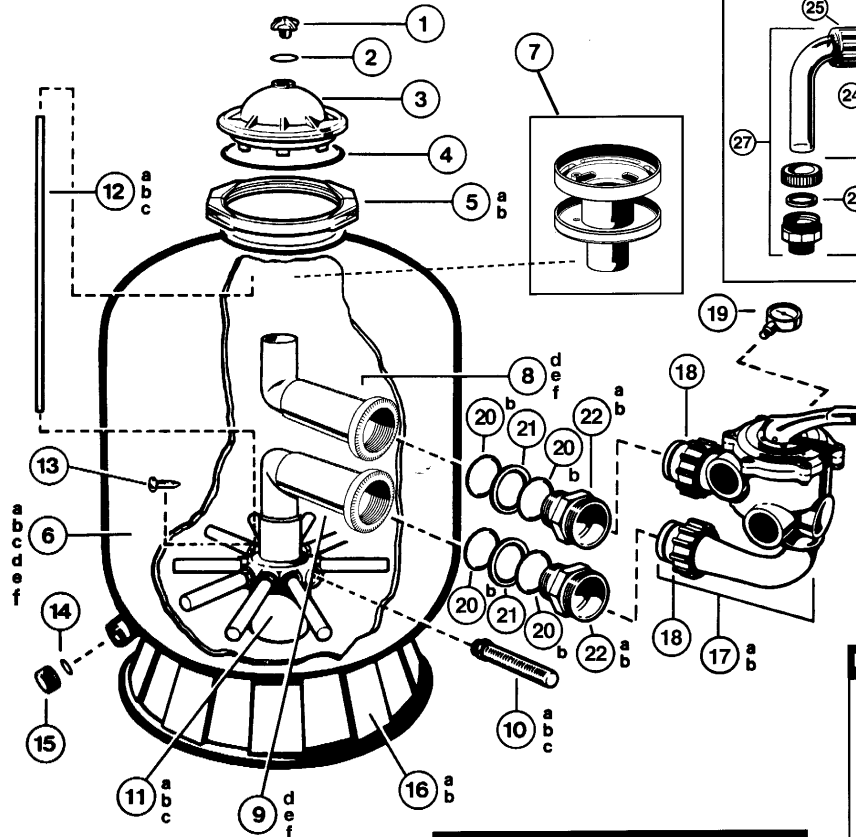

Complete
Product on
Page 112

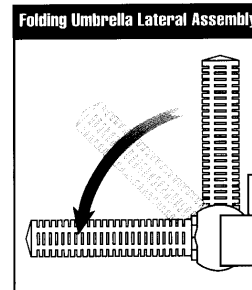
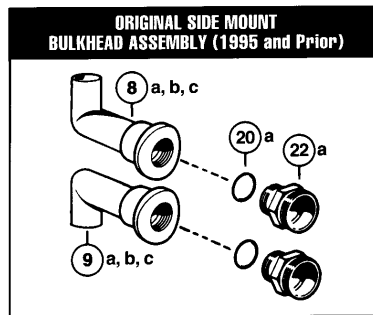

Diagram A



S200PAK3 System Base

KEY	MFG NO.	DESCRIPTION	ITEM NO.
23	ECX1291	Standard Pump/Filter Mounting Base	H6716*
24	SPX1480A	Union Ball End	H6718
25	SPX1480C	Union Nut	H6720
26	SPX1425Z6	O-Ring	H6722
27	SPX1485B3	Union Elbow with Compression Assembly	H6724
28	SPX1485G	Compression Gasket	H6727
29	ECX1161Z2	Mounting Screw Set w/Washers (2 needed)	H6544*
30	SPX1485DA	Compression Fitting with Gasket	H6235*

Complete Products on Page 111

PENTAIR (PAC-FAB) TAGELUS SAND FILTER

- TA 30D/ TA30
- TA 35D/ TA 35
- TA 40D/ TA 40
- TA 50D/ TA 50
- TA 60D/ TA 60
- TA 100D

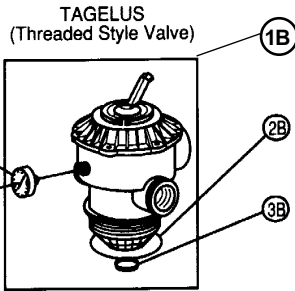

Also see valve section for additional parts



Detail A, (after 12/1/91)
6 in. btr. Thread.



Detail B, (before 12/1/91)
6 in. "V" Thread.

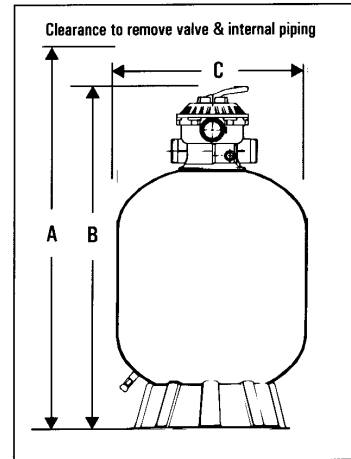
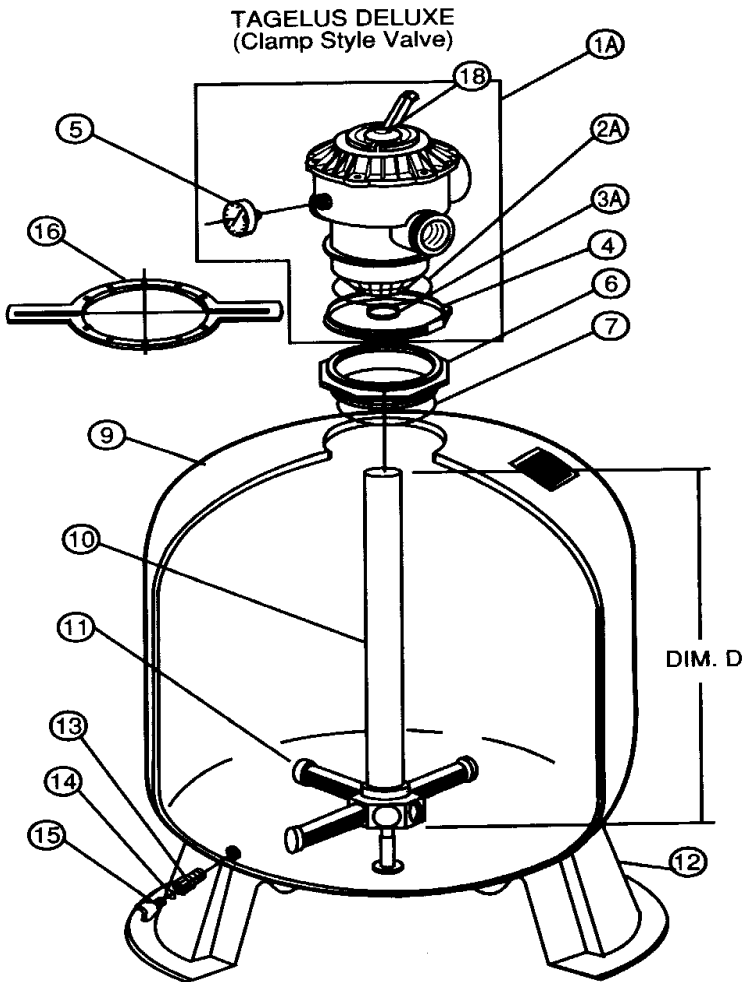

DIMENSION TABLE

MODEL	A. DIM.	B DIM.	C DIM.
TA 35D	37 ¼ in.	31 ½ in.	15 ½ in.
TA 40D	47 in.	37 in.	18 ¾ in.
TA 50D	51 ½ in.	38 ½ in.	21 ¼ in.
TA 60D	57 in.	41 ¼ in.	24 in.
TA 100D	65 ½ in.	47 ¼ in.	30 in.

KEY	MFG NO.	DESCRIPTION	ITEM NO.
1A	262506	Valve - 1-1/2" 6-Way Clamp Style (TA-30, TA35D thru TA-60D)	H4122
1A	261185	Valve - 2" 6-Way Clamp Style (TA-100D)	H4343
1B	261130	Valve - 1-1/2" 6-Way Buttruss Threads (after 12-91) Black *(See Note 5)	H4121
1B	261124	Valve - 1-1/2" 6-Way "V" Type Threads (before 12-91) *(See Note 6)	H4120
1B	SP712-2	Valve - 1-1/2" (Hayward Brand) "V" Type Threads	H8002
2A	272541	O-Ring, Valve Body (TA-30D thru TA-60D models only)	H4344
2A	275333	O-Ring, Valve Body (TA-100D)	H4345
2B	154493	O-Ring, Valve Body (TA-30 thru TA-60 models only)	H4044

PENTAIR (PAC-FAB) TAGELUS SAND FILTERS

KEY	MFG NO.	DESCRIPTION	ITEM NO.
3A	355330	Standpipe O-Ring (TA-100D) <i>(See Note 1)</i>	K4631
3B	155064	Standpipe O-Ring (TA-30 thru TA-60 only) (Before 4-93 Only) <i>*(See Note 1)</i>	H4305
4	155526	Clamp, S.S., 6-1/2" (TA-30D thru TA-60D)	H4346*
4	152165	Clamp, Plastic, 6-1/2" Diameter (TA-30D thru TA-60D)	H4116
4	152130	Clamp, 8.35" Diameter (TA-100D)	H4347*
5	155050	Pressure Gauge, Back Mount	OBS
5	-----	Generic Pressure Gauge, Back Mount	H7010
6	154555	Adaptor 6" Buttress Threads (TA-30D thru TA-60D) <i>(after 11-91)</i> <i>*(See Notes 4 & 7)</i>	H4348
6	155225	Adaptor 6" "V" Type Threads (TA-30D thru TA-60D) <i>(before 11-91)</i> <i>*(See Notes 4 & 8)</i>	H4349
6	154521	Adaptor 8-1/2" Buttress Threads (TA-100D) <i>*(See Note 4)</i>	H4350*
7	154494	O-Ring, Square (TA30D thru TA-60D)	H4047
7	355619	O-Ring Valve Adaptor (TA-100D Only)	K4538
9	153445	Tank & Foot Assy w/ Valve Adaptor (TA-35D) <i>*(See Notes 2 & 7)</i>	OBS
9	155276	Tank & Foot Assy w/ Valve Adaptor (TA-40D) <i>*(See Notes 2, 7 & 8)</i>	H4354*
9	155279	Tank & Foot Assy w/ Valve Adaptor (TA-50D) <i>*(See Notes 2, 7 & 8)</i>	H4355*
9	155269	Tank & Foot Assy w/ Valve Adaptor (TA-60D) <i>*(See Notes 2, 7 & 8)</i>	H4356*
9	155324	Tank & Foot Assy w/ Valve Adaptor (TA-100D) <i>*(See Notes 2, 7 & 8)</i>	H4357*
9	153450	Tank & Foot Assy - Buttress Thread Style (TA-35) <i>*(See Note 5)</i>	OBS
9	155342	Tank & Foot Assy - Buttress Thread Style (TA-40) <i>*(See Notes 5 & 6)</i>	H4297*
9	155343	Tank & Foot Assy - Buttress Thread Style (TA-50) <i>*(See Notes 5 & 6)</i>	H4298*
9	155344	Tank & Foot Assy - Buttress Thread Style (TA-60) <i>*(See Notes 5 & 6)</i>	OBS
10	155060	Piping Assy w/ Hub (TA-30 & TA-30D) 12-7/8"	H4301
10	153455	Piping Assy w/ Hub (TA-35 & TA-35D)	H4386
10	155061	Piping Assy w/ Hub (TA-40 & TA-40D) 17-3/4"	H4302
10	155062	Piping Assy w/ Hub (TA-50 & TA-50D) 19-7/8"	H4303
10	155063	Piping Assy w/ Hub (TA-60 & TA-60D) 22-5/8"	H4304
10	155340	Piping Assy w/ Hub (TA-100D) 27-1/4"	H4362*
11	155007	Lateral (TA-30, TA-30D, TA-35 & TA-35D) 5-11/32" (8 req.)	H4294
11	152290	Lateral (TA-40 thru TA-60 & TA-40D thru TA-60D) 6-11/16" (8 req.)	H4062
11	152202	Lateral (TA-100D) 9-1/8" (8 req.)	H4206
12	154926	Tank Foot (TA-35 thru TA-60D & TA35D thru TA60D)	H4310*
12	154596	Tank Foot (TA-100D) <i>*(See Note 3)</i>	H4309*
13	154698	Drain Assembly - 3/4" (TA30) (after 1983)	H4311
13	154685	Drain Assembly - 1/2" (TA30D) (before 1983)	H4070
14	192115	O-Ring, Drain Plug 1/16" x 1/2" I.D.	H3274
15	154699	Drain Plug, 1/4" w/O-ring (after 1983)	H4312
16	154512	Wrench, 6-1/2" Across Flats (TA-30D, TA40D, TA50D & TA-60D)	H4046
16	151608	Wrench, 9" Across Flats (TA-100D)	H4365*
17	154402	Foot Mounting Tape - (TA-30 thru TA-60 & TA-30D thru TA-60D)	H4318
17	154407	Foot Mounting Tape (TA100D only)	H4319*

**(See Notes on Following Page)*

PENTAIR (PAC-FAB) TAGELUS SAND FILTERS***Special Notes***

- Note 1:** Item 3A O-Ring - Standpipe is used on model TA100D Filters Only. Item 3B O-Ring - Standpipe is used on Tagelus Filter models TA30, 40, 50, 60 manufactured before April, 1993. Item 38 is not used on Tagelus Clamp Filter models TA30D, 35D, 40D, 50D, 60D or on any Tagelus models manufactured after April, 1993.
- Note 2:** Tagelus Clamp Filter models Tank & ft. assy. has valve adaptor. (Item 6) factory installed.
- Note 3:** Replacement of Tank ft. requires the use of Mounting Tape. See part number listed.
- Note 4:** Lubricate O-Ring liberally w/ Silicone lubricant and tighten to following spec: TA30D, 35D, 40D, 50D, 60D...Handtight plus 1/4 turn min. TA100D Handtight plus 3/4 turn min.
- Note 5:** Tagelus Filter Models TA30, 35, 40, 50, 60 manufactured after Nov. 1, 1991 were manufactured w/ a buttress thread top opening and utilize a buttress style valve which is black in color. A change was made to the port arrangement in April, 1993 which will require that minor changes be made to the valve plumbing connections when replacing valves on filters manufactured between Nov. '91 and Mar. '93.
DO NOT ATTEMPT TO INTERCHANGE THREAD TYPES!!
- Note 6:** Tagelus Filter models TA30, 40, 50, 60 manufactured before Nov. 1, 1991 were manufactured w/ a "V" in. thread style valve that is white or brown in color. These valves may be replaced w/ "V" in. thread style valve P/N 26-1124, see Detail B.
DO NOT ATTEMPT TO INTERCHANGE THREAD TYPES!!
- Note 7:** Tagelus Clamp Filter models TA30D, 35D, 40D, 50D, 60D manufactured after Nov. 1, 1991 were manufactured w/ a buttress thread top opening and utilize a buttress thread valve adaptor. P/N 15-4555, See detail A.
DO NOT ATTEMPT TO INTERCHANGE THREAD TYPES!!
- Note 8:** Tagelus Clamp Filter models TA30D, 40D, 50D, 60D manufactured before Nov. 1, 1991 were manufactured w/ a "V" thread top opening and utilize a "V" thread valve adaptor. P/N 15-5225, see detail B.
DO NOT ATTEMPT TO INTERCHANGE THREAD TYPES!!

PENTAIR (PAC-FAB) TAGELUS FILTER SYSTEMS

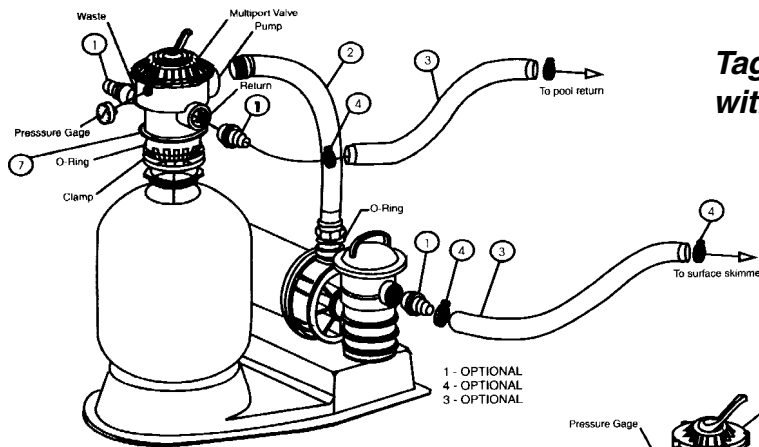

Tagelus Sand System with Clamp Style Valve

Tagelus Sand System with Threaded Valve

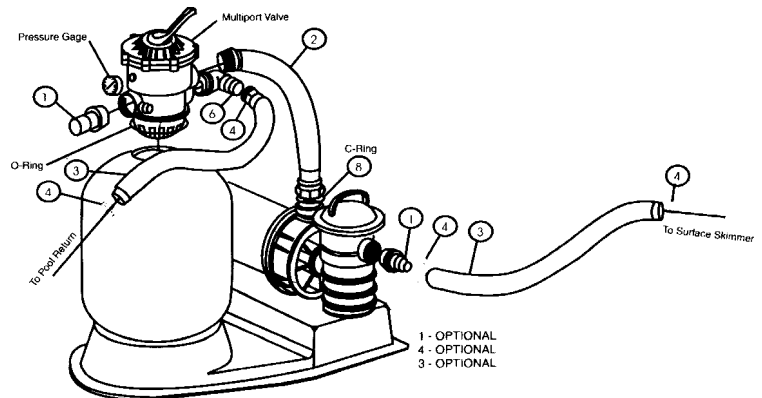

KEY	MFG. NO.	DESCRIPTION	ITEM NO.
1	711006	Hose Adapter, Tapered (3 needed)	H4142*
2	155285	PVC Hose w/ Quick Disconnect (TA-35D)	H4102
2	155278	PVC Hose w/ Quick Disconnect (TA40D)	H3046
2	155283	PVC Hose w/ Quick Disconnect (TS50D)	H4112*
3	155153	Flex Hose 1-1/2" x 6' (2 needed)	H4113*
4	711004	Hose Clamp 1-1/2" Wire Type (4 needed)	H4144*
5	-----	Teflon Tape	V1205
6	155223	Base - Elevated Platform	OBS
7	152165	Clamp TAD System	H4116

WITH THREADED VALVE

1	711006	Hose Adapter, Tapered (2 needed)	H4142*
2	155285	PVC Hose w/ Quick Disconnect (TA-35)	H4102
2	155278	PVC Hose w/ Quick Disconnect (TA400)	H3046
2	155283	PVC Hose w/ Quick Disconnect (TS50)	H4112*
3	155153	Flex Hose 1-1/2" x 6' (2 needed)	H4113*
4	155155	Hose Clamp 1-1/2" Wire Type (4 needed)	OBS
5	-----	Teflon Tape	V1205
6	155135	1-1/2" Elbow Adapter	OBS
7	155223	Base - Elevated Platform	OBS
8	354571	O-Ring	K4606

PENTAIR (PAC-FAB) TRITON II SAND FILTERS
TR-40, TR-50, TR-60, TR-100 & TR-140

KEY	MFG NO.	DESCRIPTION	ITEM NO.
1	154689	Air Bleeder/Tee Assembly	H4314*
2	154700	Adaptor - Brass Air Bleeder	H4265
3	155050	Pressure Gauge - Back Mount	H7010
4	154661	O-Ring- Air Bleeder Adaptor	H4259
5	154664	Nut, 3/8" - 16 S.S.	H4261
6	154570	Dome Closure - 6" (Buttress Thread) Black (After 12/1/91)	H4045
6	154559	Dome Closure - 6" ("V" Type Thread) Black (Before 12/1/91)	H4043
7	154493	O-Ring for 6" Closure Dome	H4044
7	154495	O-Ring for 6" Closure Dome, White	OBS
8	154578	Strainer, Air Relief (Filters Before 11/1/99)	H4339
8	150035	Strainer, Air Relief (Filters After 11/1/99)	H4059
9	154435	Air Relief Tube (TR40) (Filters Before 11/1/99)	H4235
9	150039	Air Relief Tube (TR40) (Filters After 11/1/99)	H4307*
9	154436	Air Relief Tube (TR50 & TR60) (Filters Before 11/1/99)	H4236
9	150040	Air Relief Tube (TR50 & TR60) (Filters After 11/1/99)	H4317*
9	154437	Air Relief Tube (TR100) (Filters Before 11/1/99)	H4237
9	150041	Air Relief Tube (TR100) (Filters After 11/1/99)	H4359
9	154438	Air Relief Tube (TR140) (Filters Before 11/1/99)	H4238
9	150042	Air Relief Tube (TR140) (Filter After 11/1/99)	H4360*
10	154598	Diffuser Assembly (TR40 & TR50)	H4255
10	154599	Diffuser Assembly (TR60)	H4256
10	154462	Diffuser Assembly (TR100)	H4241
10	154906	Diffuser Assembly (TR140)	H4287
11	154803	Upper Piping Assembly (TR40)	H4281
11	156814	Upper Piping Assembly (TR50)	H4202*
11	154533	Upper Piping Assembly (TR60)	H4249
11	154426	Upper Piping Assembly (TR100)	H4234
11	154500	Upper Piping Assembly (TR140)	H4247
12	154440	Connector - Air Relief Tube (Filters Built Before 2/89)	H4239
12	154421	Connector - Air Relief Tube (After 2/89 & Before 11/99)	H4208*
12	150036	Connector - Air Relief Tube (Filters Built After 11/1/99)	H4361
13	154801	Lower Piping Assembly (TR40)	H4280
13	156816	Lower Piping Assembly (TR50)	H4278*
13	154805	Lower Piping Assembly (TR60)	H4282
13	154807	Lower Piping Assembly (TR100)	H4283
13	154489	Lower Piping Assembly (TR140)	H4244
15	152290	Lateral, 6-11/16" Length (TR40, TR50 & TR60) 8 needed	H4062
15	152202	Lateral, 9-1/8" Length (TR100) - (Current) "	H4206
15	159560	Lateral, 6-1/2" Length (TR100) - (Prior to 1985) "	H4066
15	154540	Lateral, 12" Length (TR140) "	H4068
16	154763	Hub for Lateral (TR40, TR50 & TR60)	H4060
16	154453	Hub for Lateral (TR100 & TR140)	H4064
17	152220	Sand Drain 2" (Current)	H4335
17	154698	Spigot 3/4" - Sand Drain (After 3/83 Thru 3/96)	H4311
17	154685	Spigot 1/2" - Sand Drain (Filters Built Before 3/83)	H4070
18	154871	Cap Threaded 1-1/2" (Current)	H4336*
18	154699	Plug for Drain 1/4" - (After 3/83 Thru 3/96)	H4312
18	154481	Plug for Drain 1/4" (Filters Built Before 3/83)	H4243
19	154512	Wrench - Closure 6"	H4046
19	154510	Wrench - Closure, Aluminum	H4213
20	154412	Locknut - 2" Internal	H4230
21	154416	Spacer - 2" Internal	H4233
22	154492	O-Ring - 2" Bulkhead	H4246

PENTAIR (PAC-FAB) TRITON II SAND FILTERS

Complete Product on Page 110

TR-40
TR-50
TR-60
TR-100
TR-140

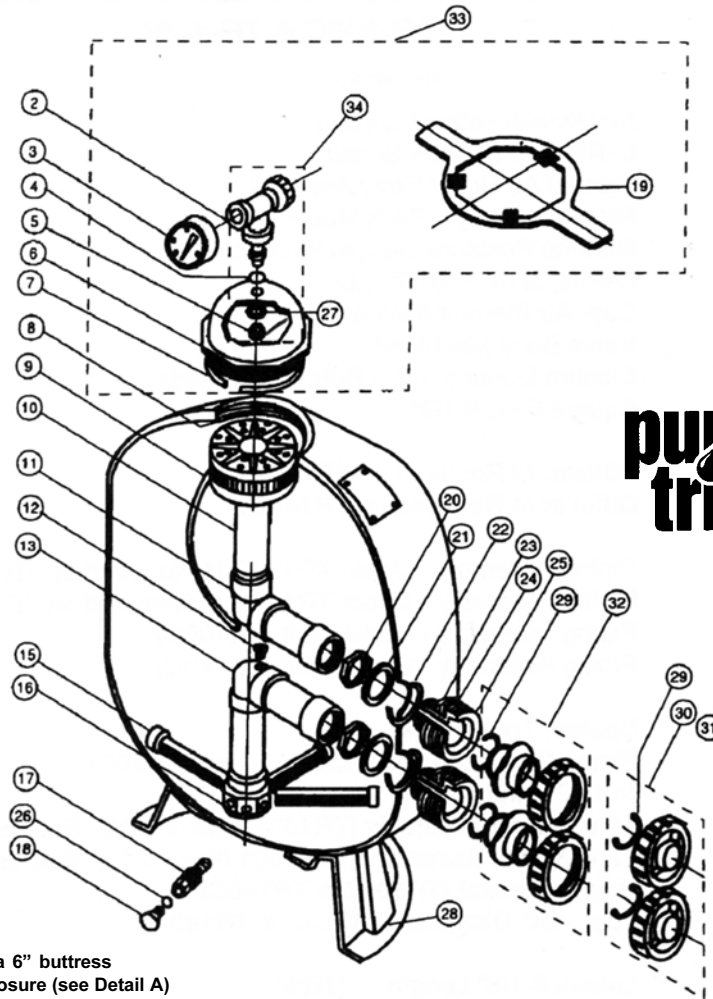
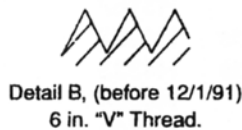
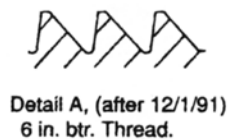

purex
triton

Filters manufactured after Dec. 1, 1991 utilize a 6" buttress thread in the filter tank top opening & on the closure (see Detail A)

Filters manufactured before Dec. 1, 1991 utilize a 6" "V" type thread (see Detail B)

KEY	MFG NO.	DESCRIPTION	ITEM NO.
23	154408	Spacer - 2" External	H4228
24	154538	Gasket - 2" Bulkhead	H4250
25	154405	Bulkhead - 2"	H4226
---	154714	Complete 2" Bulkhead Assembly - Triton	H4266
26	154492	O-Ring 3/16" x 2-5/8" I.D.	H4246
26	192115	O-Ring for Drain Plug (Filters Built After 3/83)	H3274
27	154418	Washer 3/8" S.S.	H4269
28	154926	Foot - 16" Diameter (TR-40 & TR-50) Requires Mounting Tape	H4310*
28	154520	Foot - 19" Diameter (TR-60)	H4214*
28	154596	Foot - 24" Diameter (TR-100 & TR-140)	H4309*
---	154402	Foot Mounting Tape (TR-40, TR-50 & TR-60)	H4318
---	154407	Foot Mounting Tape (TR-100 & TR-140)	H4319*
29	274494	O-Ring, Valve Adapter (2 needed)	H3371
30	271092	Kit, Valve Adaptor 2" Threaded - Pair	H4041
31	271094	Kit, Valve Adaptor 1-1/2" Threaded - Pair	H4039*
32	271096	Kit, Valve Adapter 1-1/2" & 2" Slip - Pair	H4040
33	154641	Closure Kit 6" (Buttress Thread) Black	H4218
33	154697	Closure Kit 6" ("V" Type Thread)	H4264
34	154687	Bleeder Valve Assembly - Complete (#1, #2, #4, #5 & #27)	H4050
---	151602	Bulkhead Wrench - 2"	H4201
---	272044	Clear Vacuum Relief Valve	H4221

PENTAIR (PAC-FAB) TRITON COMERCIAL FILTERS
TR-100C & TR-140C

KEY	MFG NO.	DESCRIPTION	ITEM NO.
1	273512	Air Bleeder without O-Ring	H4222
2	273513	O-Ring Air Bleeder Screw	H4223
3	273564	Manual Air Relief Body Assembly	H4242
4	155050	Pressure Gauge, Back Mount	OBS
4	-----	Generic Pressure Gauge, Back Mount	H7010
5	274494	O-Ring 3/16" x 2-5/8" I.D.	H3371
6	273501	Cap, Air Bleeder (N/A when out)	H4273*
7	273564	Valve Body Machined	H4242
8	154575	Closure Dome 8-1/2" - Buttress Threads	H4277
9	152509	Square Ring 8-1/2"	H4291
10	154599	Diffuser (2 Required on TR100C)	H4256
10	154599	Diffuser (4 Required on TR140C)	H4256
11	156355	Piping Assembly - Upper TR100C (1 Required on TR100C)	H4292
11	156355	Piping Assembly - Upper TR140C (2 Required on TR140C)	H4292
12	156344	Piping Assembly - Upper Inlet (TR100C)	H4295
12	156345	Piping Assembly - Upper Inlet (TR140C)	OBS
13	273502	Spacer, Top - Black	H4321
14	156354	Piping Connecting Assembly Upper (TR140C)	H4329*
15	194908	Nut - 2" Internal	H3162*
16	153430	Tank & Foot Assembly (TR100C) Black 8-1/2" Buttress Thrds	H4332*
16	153431	Tank & Foot Assembly (TR140C) Black 8-1/2" Buttress Thrds	H4333*
17	154453	Hub for Lateral (TR100C & TR140C)	H4064
18	154596	Foot - 24" Diameter (TR100C & TR140C)	H4309*
19	152202	Lateral 9-1/8" Length (TR100C) 8 needed	H4206
19	154540	Lateral 12" Length (TR140C) 8 needed	H4068
20	154412	Locknut - 2" Internal	H4230
21	154416	Spacer - 2" Internal	H4233
22	154492	O-Ring - 2" Bulkhead	H4246
23	154408	Spacer - 2" External	H4228
24	154538	Gasket - 2" Bulkhead	H4250
25	154405	Bulkhead - 2"	H4226
--	154714	Complete Bulkhead Assembly - 2"	H4266
26	154492	O-Ring 3/16" x 2-5/8" I.D.	H4246
27	192320	O-Ring, Drain Bulkhead	H3141
28	194801	Drain Bulkhead - 2-3/8" Buttress	H4334
30	152220	2" Sand Drain	H4335
31	274407	Nut, Drain Bulkhead Adapter	H3369
32	154871	Cap - Threaded 1-1/2"	H4336*
33	154527	Wrench for 8-1/2" Closure Dome	H4337
34	154807	Lower Piping Assembly (TR100C)	H4283
34	154489	Lower Piping Assembly (TR140C)	H4244
35	154421	Connector for Air Relief Tube (Filters Before 11/1/99)	H4208*
35	150036	Connector for Air Relief Tube (Filters After 11/1/99)	H8896*
36	273071	Screw (1 Required for TR100C) (2 Required for TR140C)	H3343

PENTAIR (PAC-FAB) TRITON COMMERCIAL FILTER TR-100C & TR-140C

Complete
Product on
Page 110

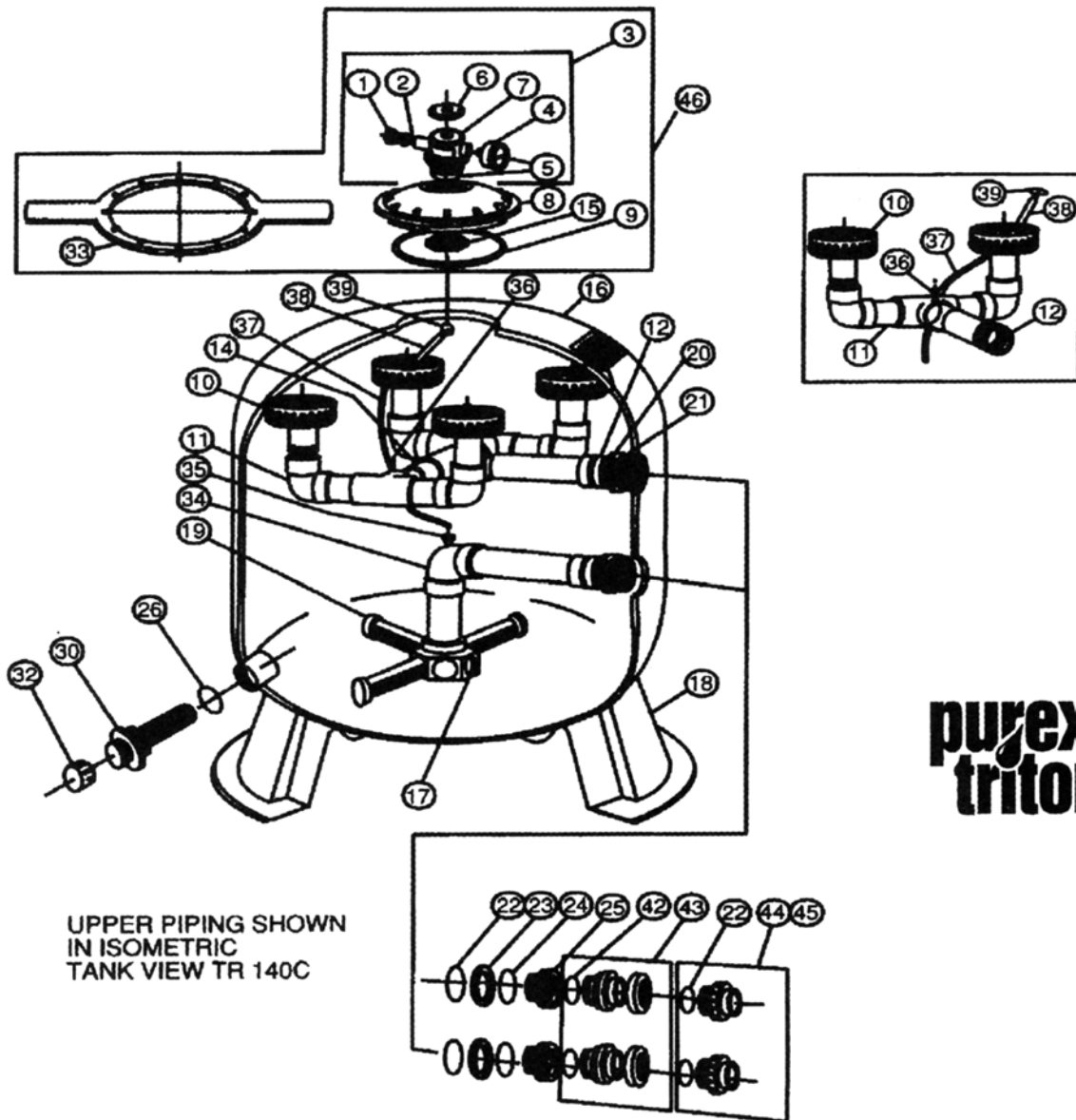

UPPER PIPING SHOWN
IN ISOMETRIC
TANK VIEW TR 140C

**purex
triton**

Sand Filters

KEY	MFG NO.	DESCRIPTION	ITEM NO.
37	154437	Tube, Air Relief (TR100C) <i>(Filters Before 11/1/99)</i>	H4237
37	150041	Tube, Air Relief (TR100C) <i>(Filters After 11/1/99)</i>	H4359
37	154438	Tube, Air Relief (TR140C) <i>(Filters Before 11/1/99)</i>	H4238
37	150042	Tube, Air Relief (TR140C) <i>(Filters After 11/1/99)</i>	H4360*
38	154507	Spacer, Air Vent Strainer 6-3/4"	H4338*
38	154508	Spacer, Air Vent Strainer 10-5/16"	H4038*
39	154578	Air Relief Strainer <i>(Filters Before 11/1/99)</i>	H4339
39	150035	Air Relief Strainer <i>(Filters After 11/1/99)</i>	H4059
42	274494	O-Ring, Valve Adapter	H3371
43	271096	Kit, Valve Adapter 1-1/2" & 2" Slip - Pair	H4040
44	271092	Kit, Valve Adapter 2" Threaded - Pair	H4041
45	271094	Kit, Valve Adapter 1-1/2" - Pair	H4039*
46	154856	Closure Kit, 8-1/2" Buttress Thread - Black	H4342

PENTAIR (PAC-FAB) TRITON C-3 COMMERCIAL FILTERS
TR-100C-3 & TR-140C-3

<i>KEY</i>	<i>MFG NO.</i>	<i>DESCRIPTION</i>	<i>ITEM NO.</i>
1	273512	Air Bleeder w/ O-Ring	H4222
2	273513	O-Ring, Air Bleeder Screw	H4223
3	273501	Cap Only for Manual Air Relief Assembly	H4273*
4	273564	Body Only for Manual Air Relief Assembly	H4242
6	155050	Pressure Guage, Back Mounted	OBS
6	-----	Pressure Guage, Back Mounted, Generic	H7010
7	274494	O-Ring, Manual Air Relief Assy., 3/16" x 2-5/8"	H3371
8	273564	Manual Air Relief Assembly	H4242
9	154575	Filter Dome - 8-1/2"	H4277
10	154412	2" Internal Nut	H4230
11	152509	Square Ring for Filter Dome	H4291
12	154527	Closure Wrench, 8-1/2"	H4337
13	154856	Closure Kit, 8-1/2" Buttress Thread	H4342
15	153430	Tank and Foot Assembly for TR100C-3	H4004*
15	153431	Tank and Foot Assembly for TR140C-3	H4007*
16	154007	Upper Piping Assembly for TR100C-3	H4021
16	154008	Upper Piping Assembly for TR140C-3	H4022
17	154005	O-Ring, (2 Needed)	H4023
18	154002	3" Spacer (2 Needed)	H4024
19	154004	O-Ring, (2 Needed)	H4026
20	154003	3" Flange Ring (2 Needed)	H4027
21	154001	3" Flange Adapter (2 Needed)	H4028
22	154009	Lower Piping Assembly for TR100C-3	H4029
22	154010	Lower Piping Assembly for TR140C-3	H4033*
23	154596	24" Foot for TR100C-3 & TR140C-3	H4309*
24	152202	Lateral, 9" Length for TR100C-3 (8 Needed)	H4206
24	154540	Lateral, 12" Length for TR140C-3 (8 Needed)	H4068
25	154871	Threaded Cap, 1-1/2"	H4336*
26	152220	Sand Drain, 2"	H4335
27	274494	O-Ring, 3/16" x 2-5/8" (2 Needed)	H3371
28	154440	Air Relief Tube Connector	H4239
29	154437	Air Relief Tube, 23" for TR100C-3	H4237
29	154438	Air Relief Tube, 27" for TR140C-3	H4238
30	154017	Diffuser Piping Assembly for TR100C-3 (2 Needed)	OBS
30	154018	Diffuser Piping Assembly for TR140C-3 (2 Needed)	H4036*
31	552474	Screw, #10 - 1-1/2" Flat Philips Head (2 Needed)	OBS
32	154599	Diffuser (2 Required on TR100C-3)	H4256
32	154599	Diffuser (4 Required on TR140C-3)	H4256
33	154507	Spacer, 6-3/4" for TR100C-3	H4037*
33	154508	Spacer, 10-5/16" for TR140C-3	H4038*
34	154578	Air Relief Strainer	H4339

PENTAIR (PAC-FAB) TRITON C-3 COMMERCIAL FILTERS
TR-100C-3 & TR-140C-3

Complete
 Product on
 Page 110

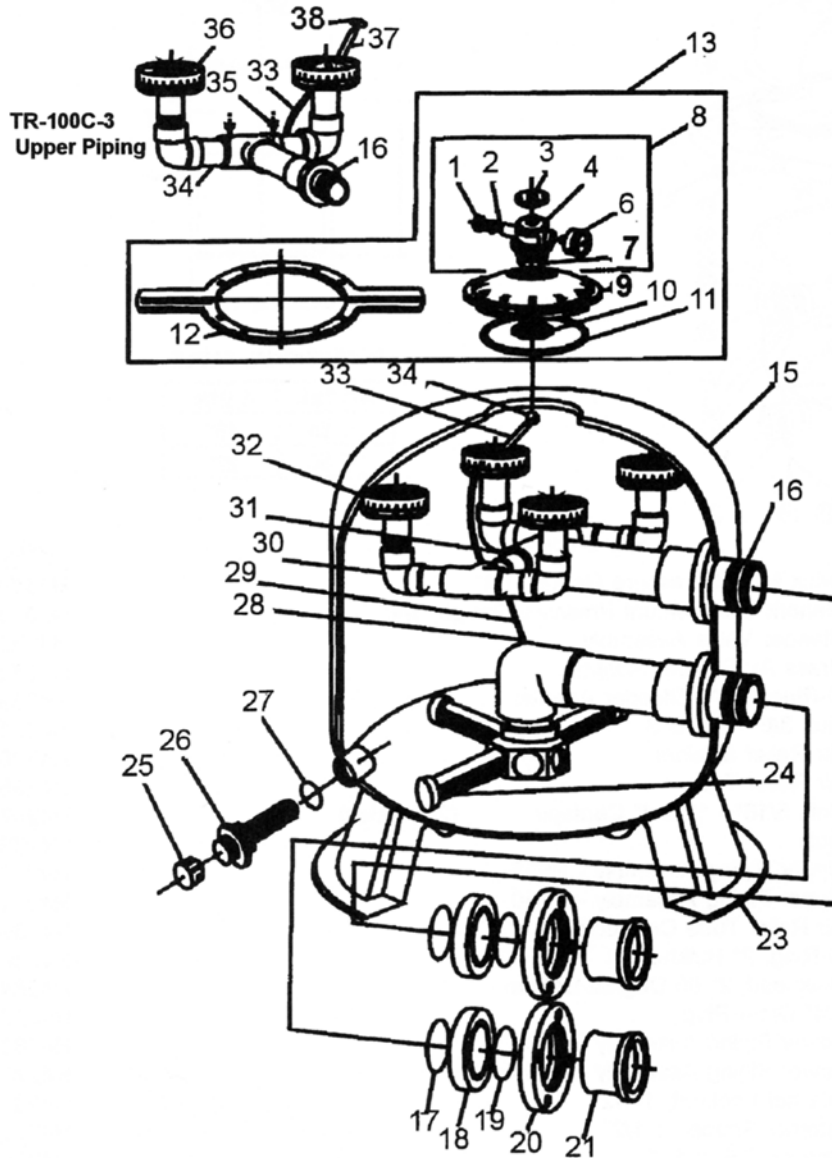

PENTAIR (PAC-FAB) TRITON C-3 COMMERCIAL FILTERS
Oval Closure Kit & Components

MFG NO.	DESCRIPTION	ITEM NO.
53003201	Pressure Gauge, 1/4"	H7000
154581	Knob for Triton C-3 Tank	H4056
154582	Spring	H4057*
154579	Bridge	H4058*
273512	Air Bleeder with O-Ring	H4222
154576	Oval Closure	H4055
152509	Square Ring 8-1/2" for Closure	H4291
156841	Complete C-3 Closure Kit - Oval	H4048

American Products Ultra-Flow	370-371
Hayward Super Pumps SP-1600X Series	372
Hayward Super Pumps SP-2600X Series	373
Hayward Northstar SP-4000X Series	374
Jandy Stealth	375
Jandy Stealth SHPF / SHPM	376-377
Pentair Challenger High Flow	378-379
Pentair Challenger High Head	380-381
Purex / Pentair Whipperflo “WFE” Series	382
Sta-Rite Pentair Dura-Glas & Max-E-Glas	383-384
Pentair EQ Commercial Plastic Pumps	385-387

AMERICAN PRODUCTS ULTRA-FLOW PUMPS

Complete Product on Page 147

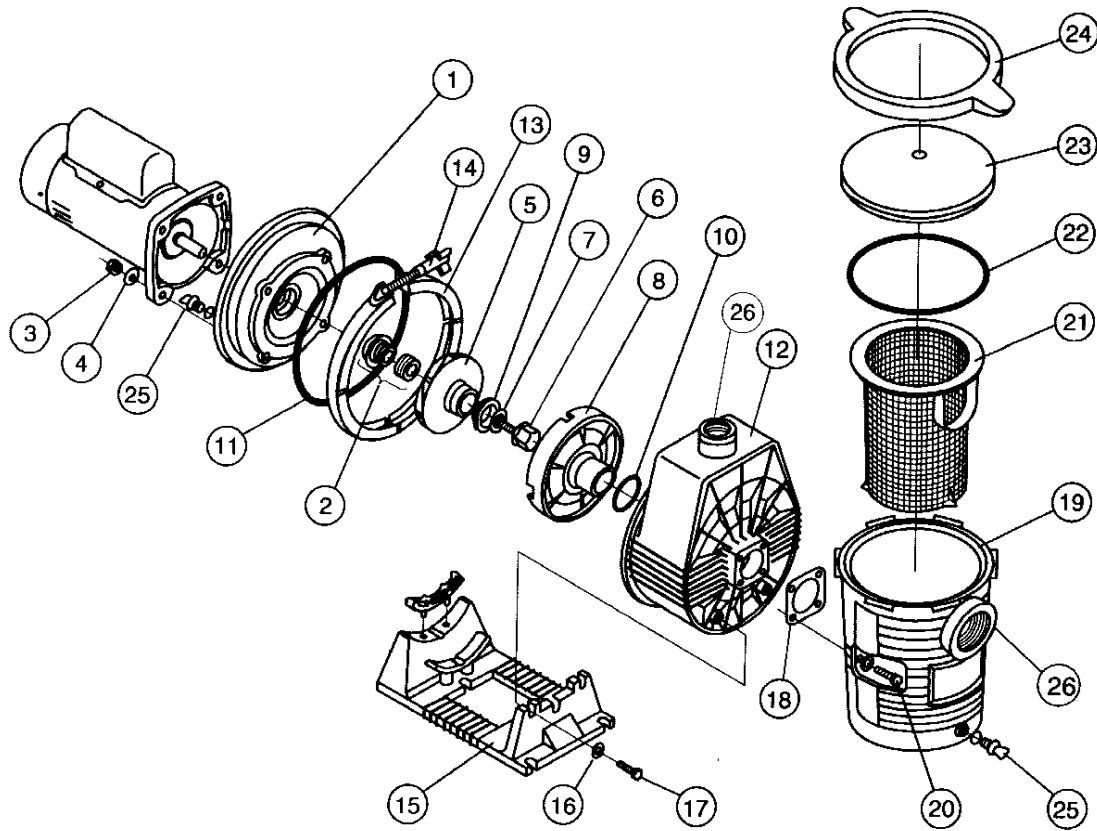

**purex
triton**

Pool and Spa Systems

KEY	MFG NO.	DESCRIPTION	ITEM NO.
1	357143	Seal Plate	K3839
1	357142	Seal Plate, Kit	K3700
2	071734	Shaft Seal	K9386
2	-----	Generic Shaft Seal #1000	K6054
3	98220500	Nut, Brass, 3/8 - 16 Hex	K3896
4	98220600	Washer, Lock, 3/8, S/S	K3828

AMERICAN PRODUCTS ULTRA-FLO PUMPS

KEY	MFG.NO.	DESCRIPTION	ITEM NO.
5	39005600	1/2 HP Impeller, Full Rated	K3842
5	39005000	3/4 HP Impeller, Full Rated	K3843
5	39005100	1 HP Impeller, Full Rated	K3844
5	39005200	1-1/2 HP Impeller, Full Rated	K3845
5	39005300	2 HP Impeller, Full Rated	K3846
5	39005400	3 HP Impeller, Full Rated	K3847
6	39009900	Screw, Impeller Lock, Left Hand Threaded	K3795
8	39005500	Diffuser, 1/2 to 1-1/2 HP	K3848
8	39015500	Diffuser, 2 and 3 HP	K3714
9	39006900	Wear Ring <i>(Install Smaller Side Toward Impeller)</i>	K3849
10	39006600	Gasket, Diffuser	K3850
11	39006000	O-Ring, Volute	K3851
12	357141	Volute, 1-1/2"	K3852
12	357140	Volute, 2"	K3853
13	39006200	Clamp Assembly, Volute	K3854
14	39302700	Knob, Clamp	K3816
15	357139	Base	K3855
16	072184	Washer, Flat 3/8"	K3828
17	98219800	Bolt, 5/16-18 x 1"	K3856
18	39501200	Gasket, Pot to Volute	K3857
19	39201810	Pot, 1-1/2" Threaded, w/Wear Ring (before 11-94) <i>(Replaces# 39307300)</i>	K3838
19	357138	Pot, 1-1/2" Threaded w/Wear Ring (after 11-94)	K3716*
19	39202010	Pot, 2" Threaded, w/Wear Ring (before 11-94) <i>(Replaces # 39007100)</i>	K3837
19	357137	Pot, 2" Threaded w/Wear Ring (after 11-94)	K3718
20	98201800	Bolt, 1/4 - 20 x 1-3/4"	K3858
21	39303500	Basket, Strainer	K3835
22	39300300	O-Ring, Lid (before 11-94)	K3811
22	39300600	O-Ring, Lid (after 11-94)	K3905
23	39301700	Lid	K3906
24	39303000	Clamp Assembly Pot (before 11-94)	K3861
24	39105000	Locking Ring, Pot Lid (after 11-94)	K3908
25	98206400	Plug 1/4" w/O-Ring	H3621
26	39007200	Ring Reinforcing, for Ports 2"	K3863*
26	39204600	Ring, Reinforcing, for Ports 1-1/2"	K3836
--	98208300	Screw, HH 1/4-20 x 7/8	K3897
--	51008500	Flat Washer, 1/4"	K3898
--	39302800	Clamp Only	K3899*
--	Go Kit 20	Pump Repair Kit (Gaskets & Seal)	K6009

*Non-Stock Item

HAYWARD SUPER PUMPS
SP-1600X Series (Max Rated)

KEY	MFG NO.	DESCRIPTION	ITEM NO.
1	SPX1600P	Hand Knob with Swivel Nut	K4306
2	SPX1600N	Swivel Nut	K4302
3	SPX1600D	Strainer Cover, Clear Lexan	K4298
4	SPX1600S	Gasket for Strainer Cover	K4300
5	SPX1600M	Basket for Strainer (B-167)	K7167
6	SPX1600V	Drain Plug 1/4" (1991 & Prior)	K4295
6	SPX1700FG	Drain Plug 1/4" with Gasket	K4284
7	SPX1600AA	Pump Housing / Strainer, 1-1/2" x 1-1/2" with Drain Plugs	K4290
7	SPX1620AA	Pump Housing / Strainer, 2" x 2" with Drain Plugs	K4292
8	SPX1600R	Diffuser Gasket	K4296
9	SPX1600B	Diffuser, 1/2 HP (Medium Head)	K4326
9	SPX1605B	Diffuser, 3/4 HP (Medium Head)	K4328
9	SPX1607B	Diffuser, 1 HP (Medium Head)	K4330
9	SPX1608B	Diffuser, 1 HP (High Head)	K4332
9	SPX1610B	Diffuser, 1-1/2 HP (Medium Head)	K4334
9	SPX1608B	Diffuser, 1-1/2 HP (High Head)	K4332
9	SPX1615B	Diffuser, 2 HP & 2-1/2 HP (Medium Head)	K4338
9	SPX1616B	Diffuser, 2 HP & 2-1/2 HP (High Head)	K4340
10	SPX1621C	Impeller, 2-1/2 HP (High Head)	K4356
11	SPX1600Z2	Seal Assembly	K4392
11	AS-1521	Generic Shaft Seal	K6062
12	SPX1600T	Gasket for Housing	K4294
13	SPX1600E	Seal Plate (Medium Head)	K4358
13	SPX1611E	Seal Plate (High Head)	K4360
14	SPX1600F	Motor Mounting Plate	K4394
15	SPX1600Z4	Housing Cap Screw	K4396
16	SPX0125Z44	Motor Cap Screw (Set of 4)	K4398
17,18	SPX1600GJ	Mounting Feet - Long (Set Left & Right) w/Adapter	K4386
---	SPX1600Q	Mounting Leg Adapter (48 Frame Motors)	K4312
19	SPX1600Z54	Mounting Foot Cap Screw (Set of 4)	K4390
20	SPX0125F	Slinger	K4324
21	SPX1600Z1M	Motor, 1/2 HP - Threaded Shaft (115V)	K5090*
21	SPX1605Z1M	Motor, 3/4 HP - Threaded Shaft (115/230V)	K5091*
21	SPX1607Z1M	Motor, 1 HP - Threaded Shaft (115/230V)	K5092*
21	SPX1610Z1M	Motor, 1-1/2 HP - Threaded Shaft (115/230V)	K5093*
21	SPX1615Z1M	Motor, 2 HP - Threaded Shaft (115/230V)	K5094*
21	SPX1620Z1M	Motor, 2-1/2 HP - Threaded Shaft (230V)	K5095*
---	GO-KIT 3	Aladdin Pump Repair Kit (Gaskets & Seal)	K6003

*Non-Stock Item

HAYWARD SUPER PUMP SP-2600X Series (Max Rated)

Complete
Product on
Page 136

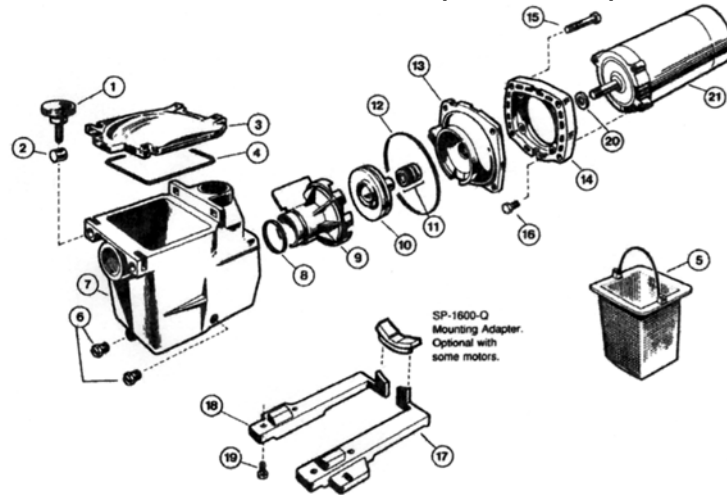

KEY	MFG NO.	DESCRIPTION	ITEM NO.
1	SPX1600P	Hand Knob with Swivel Nut	K4306
2	SPX1600N	Swivel Nut	K4302
3	SPX1600D	Strainer Cover, Clear Lexan	K4298
4	SPX1600S	Gasket for Strainer Cover	K4300
5	SPX1600M	Basket for Strainer (B-167)	K7167
6	SPX1600V	Drain Plug, 1/4" (1991 & Prior)	K4295
6	SPX1700FG	Drain Plug with Gasket, 1/4"	K4284
7	SPX1600AA	Pump Housing/Strainer, 1-1/2" x 1-1/2" with Drain Plugs	K4290
7	SPX1620AA	Pump Housing/Strainer, 2" x 2" with Drain Plugs	K4292
8	SPX1600R	Gasket, Diffuser	K4296
9	SPX2600B	Diffuser, 1/2 HP thru 2 HP	K4362
9	SPX1616B	Diffuser, 2-1/2 HP	K4340
10	SPX2600C	Impeller, 1/2 HP	K4361
10	SPX2605C	Impeller, 3/4 HP	K4364
10	SPX2607C	Impeller, 1 HP	K4365
10	SPX2610C	Impeller, 1-1/2 HP	K4366
10	SPX2615C	Impeller, 2 HP	K4367
10	SPX1621C	Impeller, 2-1/2 HP	K4356
11	SPX1600Z2	Seal Assembly	K4392
11	AS-1521	Generic Shaft Seal	K6062
12	SPX1600T	Housing Gasket	K4294
13	SPX2600E	Seal Plate, 1/2 HP thru 2 HP	K4363
14	SPX1611E	Seal Plate, 2-1/2 HP	K4360
15	SP1600Z4	Housing Cap Screw	K4396
16	SPX0125Z44	Motor Cap Screw (Set of 4)	K4398
17,18	SPX1600GJ	Mounting Feet - Long (Set Left & Right) w/Adaptor	K4386
--	SPX1600Q	Mounting Leg Adapter	K4312
19	SPX1600Z52	Mounting Foot Cap Screw (Set of 4)	K4390
20	SPX0125F	Slinger	K4324
21	SPX1600Z1M	Motor, 1/2 HP Threaded Shaft (115V)	K5090
21	SPX1605Z1M	Motor, 3/4 HP Threaded Shaft (115/230V)	K5091
21	SPX1607Z1M	Motor, 1 HP Threaded Shaft (115/230V)	K5092
21	SPX1610Z1M	Motor, 1-1/2 HP Threaded Shaft (115/230V)	K5093
21	SPX1615Z1M	Motor, 2 HP Threaded Shaft (115/230V)	K5094
21	SPX1620Z1M	Motor, 2-1/2 HP Threaded Shaft (230V)	K5095

HAYWARD NORTHSTAR PUMP SP4000X Series (Max Rated)

Complete
Product on
Page 136

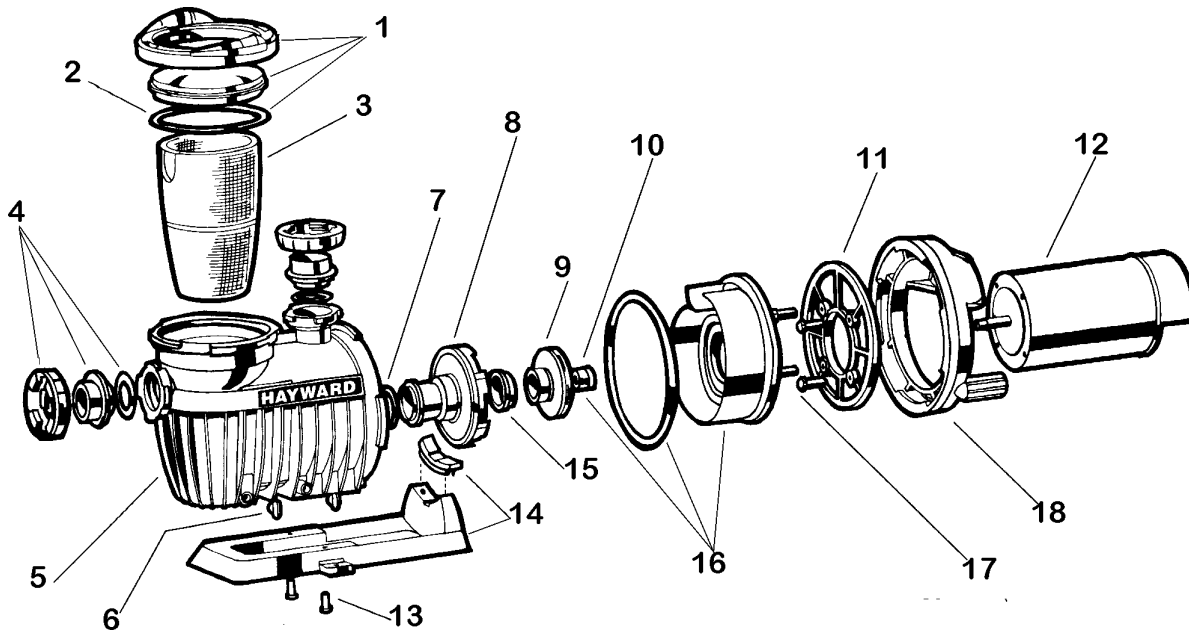

KEY	MFG.NO.	DESCRIPTION	ITEM NO.
1	SPX4000DA	Strainer Cover Kit (Strainer Cover, Lock Ring, O-Ring)	K4479
2	CX400G	Strainer Cover O-ring	K4481
3	SPX4000M	Basket	K4483
4	SPX4000UNPAK1	Union Kit	K4485
4A	SPX4000Z1	O-Ring for Union	K4466
5	SPX4020AA	Pump Housing	K4486
6	SPX4000FG	Drain Plug w/ Gasket	K4487
7	SX360Z1	Diffuser O-ring	K4488
8	SPX4000B	Diffuser	K4489
9	SPX4007C	Impeller for 1 HP (SP4007X10NS)	K4449
9	SPX4010C	Impeller for 1 1/2 HP (SP4010X15NS)	K4450
9	SPX4015C	Impeller for 2 HP (SP4015X20NS)	K4452
9	SPX4020C	Impeller for 2 1/2 HP (SP4020X25NS)	K4453
9	SPX4025C	Impeller for 3 HP (SP4025X30NS)	K4455
10	SPX1600Z2	Seal Assembly	K4392
11	SPX4000F	Motor Mounting Plate	K4456
12	SPX1607Z1MNS	Motor, 1 HP (SP4007X10NS)	K4457
12	SPX1610Z1MNS	Motor, 1 1/2 HP (SP4010X15NS)	K4458
12	SPX1615Z1MNS	Motor, 2 HP (SP4015X20NS)	K4459
12	SPX1620Z1MNS	Motor, 2 1/2 HP (SP4020X25NS)	K4460
12	SPX1625Z1MNS	Motor, 3 HP (SP4025X30NS)	K4461
13	SPX1600Z52	Mounting Foot Cap Screw	K4390
14	SPX4000GA	Mounting Base w/ Adapter	K4463*
15	SPX3021R	Impeller Ring 2 & 3 HP	K4271
16	SPX4000SEALKIT	Seal Plate Kit	K4464*
16A	SPX4000T	O-Ring for Seal Plate	K4467
17	SPX0125Z44	Motor Cap Screw	K4398
18	SPX4000K	Motor Lock Ring	K4465

*Non-Stock Item

JANDY STEALTH PUMPS

Complete
Product on
Page 135

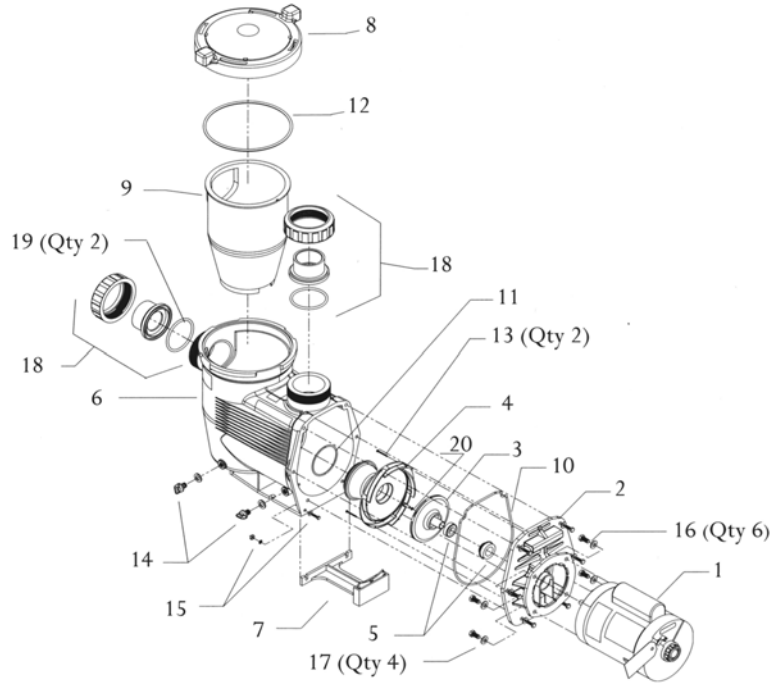

			ITEM NO.
2	R0556000	Mounting Bracket	K5281
3	R0555801	Impeller, JHP / PHP .75 hp	K2583
	R0555802	Impeller, JHP / PHP 1.0 hp	K2585
	R0555803	Impeller, JHP / PHP 1.5 hp	K2587
	R0555804	Impeller, JHP / PHP 2.0 hp	K2589
	R0555805	Impeller, JHP / PHP 3.0 hp	K2591
3	R0555801	Impeller, JHPU / PHPU 1.0 hp	K2583
	R0555802	Impeller, JHPU / PHPU 1.5 hp	K2585
	R0555803	Impeller, JHPU / PHPU 2.0 hp	K2587
	R0555804	Impeller, JHPU / PHPU 2.5 hp	K2589
4	R0555701	Diffuser w/ cone and Cone O-ring (.75 hp - 2.5 hp)	K2593
4	R0555705	Diffuser w/ cone and Cone O-ring (JHP 3.0 hp)	K2595
5	R0338200	Mechanical Seal	K6058
6	R0555600	Pump Body	K2597
7	R0559200	Mounting Foot Assy	*
8	R0555300	Pot Lld w/ Clamp Ring	K2599
9	R0555500	Pot Basket	K2590
10	R0555900	Gasket, Body	K2601
11	R0558705	Diffuser Cone O-Ring .75 - 2.5 hp	K2605
11	R0558705	Diffuser Cone O-Ring 3.0 hp	K2605
12	R0555400	O-Ring, Pot Lid	K2592
13	R0555201	Hardware Set, Diffuser Mounting	*
14	R0559500	Drain Plugs (2)	K2604
15	R0339200	Hardware Set (2), Foot Mounting	*
16	R0339300	Hardware Set (6), Bracket Mounting	*
17	R0339400	Hardware Set (4), Motor Mounting	*
18	R0556300	Coupling Nut Set (2 - 2 1/2") .75 - 2.5 hp	H2314
18	R0559900	Coupling Nut Set (2 1/2 - 3") 3.0 hp	H2315
19	R0339600	O-Ring, (2) for coupling nut	K2612

*Non-Stock Item

JANDY SHPF / SHPM PUMPS - "STEALTH SERIES"

Complete Product on Page 135

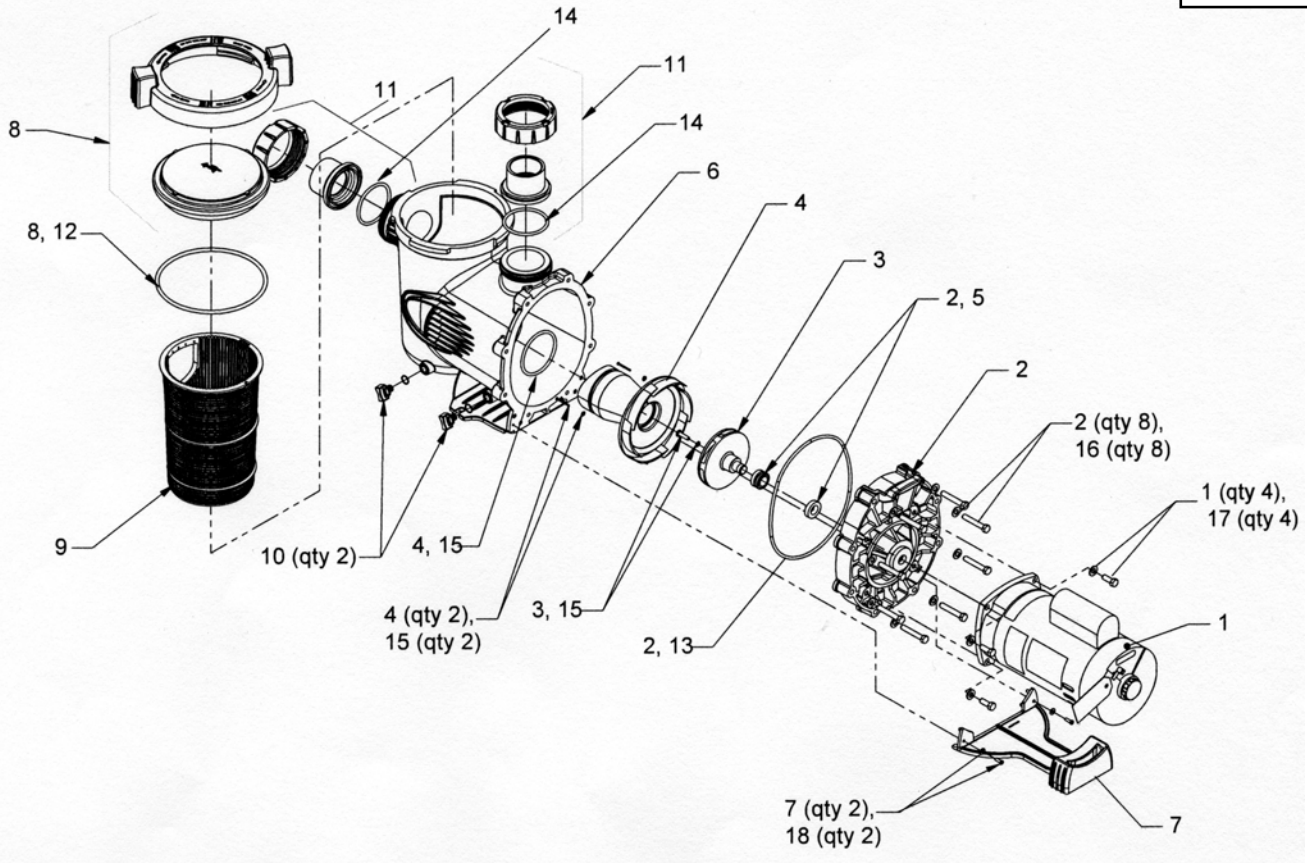

KEY	MFG NO.	DESCRIPTION	ITEM NO.
1	R0445101	Motor, single-speed SHPF (.75 HP)	*
1	R0445102	Motor, single-speed SHPF (1.0 HP)	*
1	R0445103	Motor, single-speed SHPF (1.5 HP)	*
1	R0445104	Motor, single-speed SHPF (2.0 HP)	*
1	R0445105	Motor, single-speed SHPF (3.0 HP)	*
1	R0445101	Motor, single-speed SHPM (1.0 HP)	*
1	R0445102	Motor, single-speed SHPM (1.5 HP)	*
1	R0445103	Motor, single-speed SHPM (2.0 HP)	*
1	R0445104	Motor, single-speed SHPM (2.5 HP)	*
1	R0445106	Motor, 2-speed SHPM (2.0 HP)	*
1	R0445107	Motor, 2-speed SHPM (2.5 HP)	*
1	R0445101-07	Bolts (4)	*
		Washers (4)	*
2	R0445200	Backplate, SHPF/SHPM	K2616
		Mechanical Seal, Carbon	
		Mechanical Seal, Ceramic	
		O-ring	
		Bolts (8)	
		Washers (8)	
3	R0445302	Impeller, SHPF (.75 HP)	K2617
3	R0445303	Impeller, SHPF (1.0 HP)	K2618
3	R0445304	Impeller, SHPF (1.5 HP)	K2619
3	R0445305	Impeller, SHPF (2.0 HP)	K2620
3	R0445306	Impeller, SHPF (3.0 HP)	K2621

*Non-Stock Item

JANDY SHPF / SHPM PUMPS - "STEALTH SERIES"

3	R0445302	Impeller, SHPM (1.0 HP)	K2617
3	R0445303	Impeller, SHPM (1.5 HP)	K2618
3	R0445304	Impeller, SHPM (2.0 HP)	K2619
3	R0445305	Impeller, SHPM (2.5 HP)	K2620
3	R0445304	Impeller, 2-speed SHPM (2.0 HP)	K2619
3	R0445305	Impeller, 2-speed SHPM (2.5 HP)	K2620
3	R0445302-06	Screw with O-ring, Self-sealing	*
4	R0445400	Diffuser	K2622
		Screw (2)	
		Washer (2)	
		O-ring	
5	R0445500	Mechanical Seal, Carbon	K2615
		Mechanical Seal, Ceramic	*
6	R0445601	Body, Pump, SHPF/SHPM	K2623
7	R0445700	Motor Mounting Foot	*
		Assembly, SHPF/SHPM	
		Screws (2)	
8	R0445800	Locking Ring	K2624
		Lid	
		O-ring	
9	R0445900	Filter Basket	K2625
10	R0446000	Plug, Drain (2)	K2614
		O-ring (2)	
11	R0446101	Tail Piece (2" b 2½") (.75 HP) (2)	K2610
		Coupling Nut (2.5 HP) (2)	
		O-ring (2)	
11	R0446102	Tail Piece (2½" by 3") (3.0 HP) (2)	K2626
		Coupling Nut (2)	
		O-ring (2)	
12	R0446200	O-ring, Lid	K2627
13	R0446300	O-ring, Backplate	K2628
14	R0446400	O-ring, Tail Piece	K2629
15	R0446500	Diffuser/Impeller Hardware	K2630
		Screw w/O-ring, Self-sealing,	
		Impeller Mounting	
		Screw, Diffuser Mounting (2)	
		Washer, Diffuser Mounting (2)	
		O-ring, Diffuser	
16	R0446600	Backplate Hardware	*
		Bolts (8)	
		Washer (8)	
17	R0446700	Motor Hardware	*
		Bolts (4)	
		Washer (4)	
18	R0446800	Screws, Motor Mounting Foot (2)	*

*Non-Stock Item

PENTAIR (PAC-FAB) CHALLENGER PUMPS
High Head Models

KEY	MFG NO.	DESCRIPTION	ITEM NO.
1	-----	Motor, Square Flange (See Motor Pages 217-219)	-----
2	355303	Seal Plate	K4622
3	355384	Mounting Plate, 1/2 HP Full-Rate & 3/4 HP Up-Rate	K4637
3	355317	Mounting Plate, 3/4 HP - 3 HP Full & 1 HP - 2-1/2 HP U-R	K4627
4	354545	Mechanical Shaft Seal 5/8" (#200)	K6030
5	355147	Impeller, 1/2 HP Full-Rate & 3/4 HP Up-Rate	K4614
5	355187	Impeller, 3/4 HP Full-Rate & 1 HP Up-Rate	K4616
5	355369	Impeller, 1 HP Full-Rate & 1-1/2 HP Up-Rate	K4636
5	355315	Impeller, 1-1/2 HP Full-Rate & 2 HP Up-Rate	K4625
5	355604	Impeller, 2 HP Full-Rate & 2-1/2 HP Up-Rate (After 10/1/92)	K4645
5	355431	Impeller (Obsolete) <i>Used on 2 HP Full-Rate & 2-1/2 HP Up-Rate Pumps</i>	N/A
		<i>Built Prior to 10/1/92 - Must Replace with 35-5545 Diffuser & 35-5604 Impeller</i>	
5	355544	Impeller, 3 HP Full-Rate	K4640
6	355148	Diffuser, 1/2 HP Full-Rate & 3/4 HP Up-Rate	K4615
6	355188	Diffuser, 3/4 HP - 1 HP Full-Rate & 1 HP - 1-1/2 HP Up-Rate	K4617
6	355270	Diffuser, 1-1/2 HP Full-Rate & 2 HP Up-Rate	K4618
6	355316	Diffuser (Obsolete) <i>Used on 2 HP Full-Rate & 2-1/2 Hp Up-Rate Pumps</i>	N/A
		<i>Built Prior to 10/1/92 - Must Replace with 35-5545 Diffuser & 35-5604 Impeller</i>	
6	355545	Diffuser, 2 HP - 3 HP Full-Rate & 2-1/2 HP Up-Rate	K4641
7	355320	Band Clamp Assembly - Complete	K4644
8	355302	Front Housing	K4621
9	354290	Screw, 3/8" - 16 S.S. Hex Head	K4548
10	355389	Impeller Locking Screw	K4638
11	355305	Pump Base (See Note 4)	K4623
11A	355492	Adapter - Dual Radius Motor Support	K4553*
11B	355385	Adapter - 5-5/8" Diameter Motor	K4554*
12	355334	Screw, 8-32 x 1" S.S. Hex Washer Head (3 needed)	K4634
13	355331	O-Ring for Diffuser	K4632
14	355329	Front Housing O-Ring	K4630

*Non-Stock Item

PENTAIR (PAC-FAB) CHALLENGER PUMPS High Head Models

Complete
Product on
Page 145

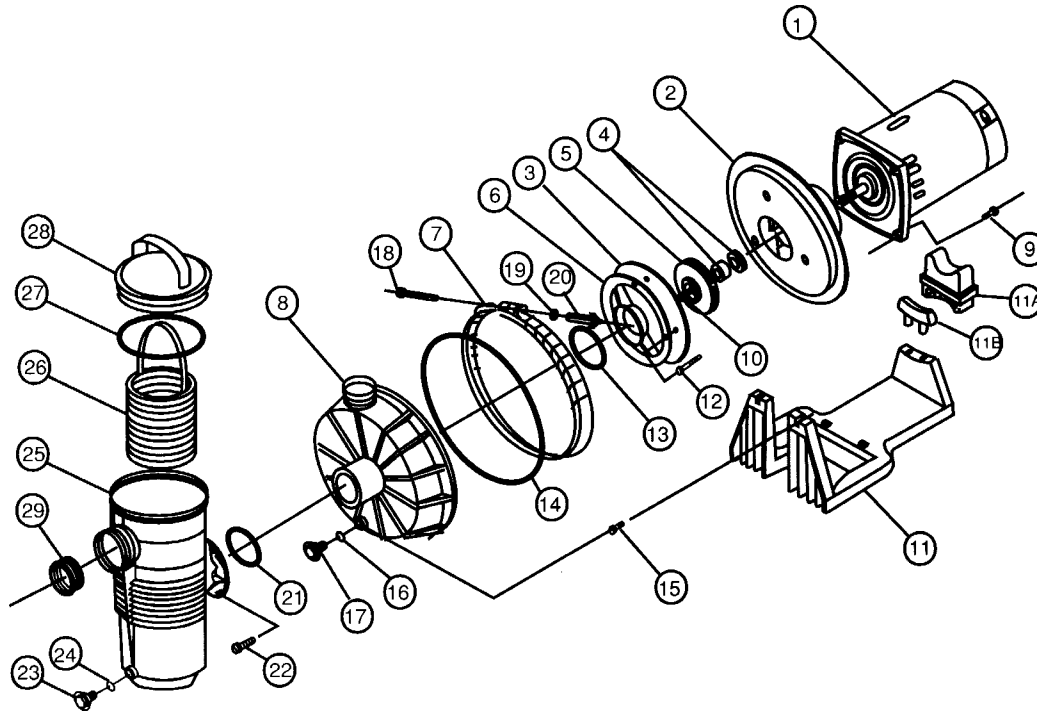

KEY	MFG NO.	DESCRIPTION	ITEM NO.
15	355335	Screw, 5/16" - 18 x 1/2" S.S.Hex Washer Head (2 needed)	K4635
16	192115	O-Ring for Drain Plug	H3274
17	154699	Drain Plug w/ O-Ring, 1/4"	H4312
18	152060	Carriage Bolt, 5/16"-18 - 4" (Repl Part for O.S. Clamp Assy)	H4207
19	639822	Flat Washer, 5/16" S.S.	L1553
20	174882	Knob (Fits Clamp with Removable Bolt Only)	H5138
20	175025	Knob (Fits Clamp with Captured T-Bolt Only)	K4555
21	355330	O-Ring, Strainer Pot Flange	K4631
22	354265	Screw, 5/16"-18 x 3/4" S.S. Hex Washer Head (4 needed)	K4543
23	154699	Drain Plug w/ O-Ring, 1/4"	H4312
24	192115	O-Ring for Drain Plug	H3274
25	355300	Strainer Pot	K4619
26	355318	Plastic Strainer Basket (All Except 3 HP Full-Rate)	K4628
26	355441	S.S. Strainer Basket (3 HP Full-Rate Only)	K4642
27	350013	Lid O-Ring (Old # 35-5332)	K4633
28	355301	Lid, Strainer Pot	K4620
28	354112	Lid, Strainer Pot BQ	K4556
28	352000	Wedgit QuikLid (Quick & Easy Replacement Lid - Also Fits Sta-Rite Pumps)	K4557*
-	Go Kit 5	Pump Repair Kit (Gasket & Seal)	K6021

*Non-Stock Item

PENTAIR (PAC-FAB) CHALLENGER PUMPS
High Flow Models

KEY	MFG NO.	DESCRIPTION	ITEM NO.
1	-----	Motor, Square Flange (See Motor Replacement Pages 217-219)	-----
1	355705	5 HP Motor, Square Flange (1-Phase)	K4689
1	355704	5 HP Motor, Square Flange (3-Phase) 230/460V	K4687
2	355303	Seal Plate	K4622
2	355497	Seal Plate, 5 HP Full-Rate	K4685
3	355028	Mounting Plate, 1/2 HP, 3/4 HP Full-Rate & 3/4 HP, 1 HP Up-Rate	K4558
3	355078	Mounting Plate, 1 HP, 1-1/2 HP Full-Rate & 1-1/2 HP, 2 HP Up-Rate	K4559
3	355095	Mounting Plate, 2 HP Full-Rate & 2-1/2 HP Up-Rate	K4560
3	355495	Mounting Plate, 5 HP Full-Rate	K4686
4	354545	Shaft Seal, 5/8" Mechanical	K6030
5	355043	Impeller, 1/2 HP Full-Rate & 3/4 HP Up-Rate	K4650
5	355067	Impeller, 3/4 HP Full-Rate & 1 HP Up-Rate	K4651
5	355074	Impeller, 1 HP Full-Rate & 1-1/2 HP Up-Rate	K4652
5	355086	Impeller, 1-1/2 HP Full-Rate & 2 HP Up-Rate	K4653
5	355093	Impeller, 2 HP Full-Rate & 2-1/2 HP Up-Rate	K4561
5	355068	Impeller, 3 HP & 5 HP Full-Rate	K4683
6	355029	Diffuser, 1/2 HP, 3/4 HP Full-Rate & 3/4 HP, 1 HP Up-Rate	K4654
6	355077	Diffuser, 1 HP, 1-1/2 HP Full-Rate & 1 HP thru 2 HP Up-Rate	K4655
6	355094	Diffuser, 2 HP Full-Rate & 2-1/2 HP Up-Rate	K4562
6	355069	Diffuser, 3 HP & 5 HP Full-Rate	K4684
7	355320	Band Clamp Assembly - Complete	K4644
8	355302	Front Housing	K4621
9	354290	Hex Head Screw, 3/8" - 16 (4 needed)	K4548
10	355389	Impeller Locking Screw	K4638
11	355305	Pump Base, Includes Item #11A	K4623
11A	355492	Adaptor - Dual Radius Motor Support	K4553*
11B	355385	Adaptor - 5-5/8" Diameter Motor (for Older Syle Bases w/2 hole mounting)	K4539*
12	355334	Screw, 8-32 Hex Washer Head (3needed)	K4634
13	355030	O-Ring, Diffuser	K4545
14	355329	O-Ring, Front Housing	K4630
15	355335	Screw, 5/16" - 18 x 1/2" S.S. Hex Washer Head (2needed)	K4635
16	192115	Drain Plug O-Ring	H3274
17	154699	Drain Plug, 1/2"	H4312
18	152060	Carriage Bolt, 5/16"-18 x 4" (Replacement Part for Old Style Clamp)	H4207
19	639822	Washer, 5/16" S.S.	L1553

PENTAIR (PAC-FAB) CHALLENGER PUMPS High Flow Models

Complete
Product on
Page 145

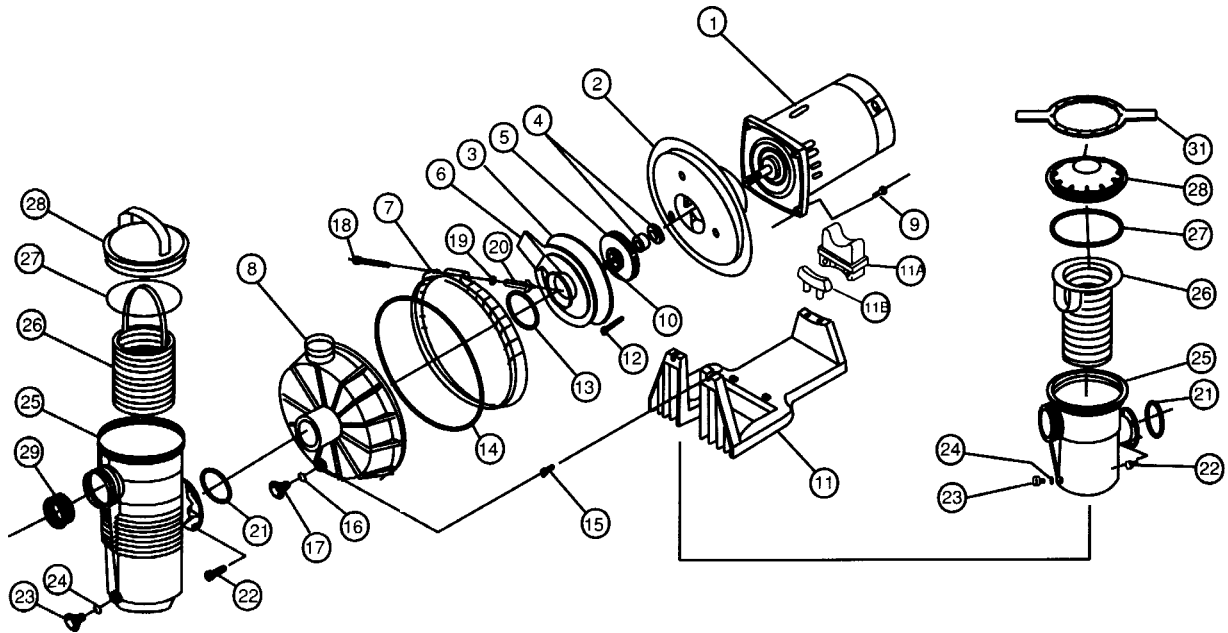

KEY	MFG NO.	DESCRIPTION	ITEM NO.
20	174882	Knob (Fits Clamp with Removable Bolt Only)	H5138
20	175025	Knob (Fits Clamp with Captured T-Bolt Only)	K4555
21	355330	O-Ring, Strainer Pot Flange	K4631
22	354265	Screw, 5/16"-18 S.S. Hex Washer Head (4 needed)	K4543
23	154699	Drain Plug, 1/4"	H4312
24	192115	O-Ring for Drain Plug	H3274
25	355300	Strainer Pot	K4619
25	355900	Strainer Pot, 5 HP (3" Suction for all large strainer pot models)	K4682
26	355318	Basket, Plastic Strainer	K4628
26	355901	Basket, Stainless Steel (5 HP)	K4681
27	350013	Lid O-Ring (Old # 35-5332)	K4633
27	152509	Square Ring - 8-1/2"	H4291
28	355301	Lid, Strainer Pot	K4620
28	354112	Lid, Strainer Pot BQ	K4556
28	355902	Lid, Strainer Pot, 5 HP Full-Rate	K4680
31	154527	Wrench, 8-1/2"	H4337
--	Go Kit 5	Pump Repair Kit (Gaskets & Seal)	K6021

PENTAIR / PUREX WHISPERFLO PUMPS

Complete Product on Page 144

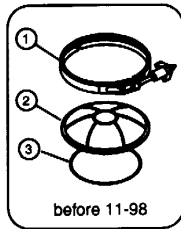

**WFE Series
High Performance
Pump**

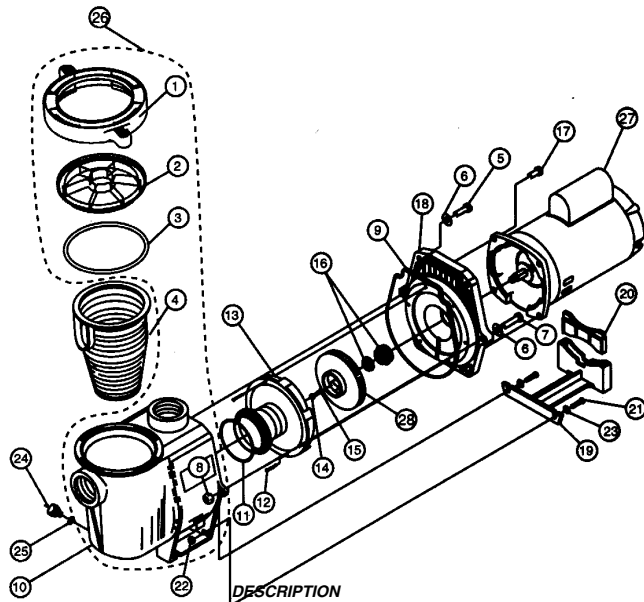

KEY	MFG NO.	DESCRIPTION	ITEM NO.
1	070711	Clamp Band Assembly WF/AQ Pump - Old Style (before 11-98)	K9302
1	357150	Clamp Band Assembly WF/AQ (after 11-98)	K9300
2	070795	Lexan Cover WFE/AQ Pump - Old Style (before 11-98)	K9304
2	357151	Lexan Cover AQ/WFE Pump (after 11-98)	K9395
3	071422	O-Ring for Cover WFE/AQ - Old Style (before 11-98)	K9306
3	350013	O-Ring AQ/WFE Cover (after 11-98)	K9422
4	070387	Basket - Plastic	K9308
5	070430	Bolt, 3/8" - 16 x 1-1/4" Hex HDSS (4 needed)	K9362
6	072184	Washer, 3/8" S.S. x 13/16" O.D. (6 needed)	K3828
7	070431	Bolt, 3/8" - 16 x 1-3/4" Hex HDSS (2 needed)	K9364*
8	071403	Nut, 3/8" - 16 Hex Head (2 needed)	K9365*
9	071445	O-Ring, Seal Plate (Before 11-98 Requires Volute Kit #357149)	K9366
9	075247	Gasket Seal Plate WFE Pump (after 6-94)	K9504*
9	357102	Gasket Seal Plate WFE Pump (after 11-98)	K9432
10	350015	Volute WFE Pump & Pot (Replaces 074565) (after 11-98)	K9371
11	071444	O-Ring, Diffuser Assembly	K9373
12	071660	Set Screw #4-40 x 1-1/8" WF (2 needed)	K9375
13	072928	Diffuser Assembly WFE-12 (3 HP Only)	K9376
13	072927	Diffuser Assembly WFE-3 thru WFE-8 (3/4 HP thru 2-1/2 HP)	K9377
14	071652	Set Screw 1/4" 20 x 1" LH Pan	K9378*
15	075713	WFE Pump Rubber Washer	K9580
16	071734	Shaft Seal with Ceramic Seat	K9386
17	070429	Bolt, 3/8" - 16 x 7/8" Hex Head (4 needed)	K9387*
18	074564	Seal Plate WFE Pump (after 1994)	K9299
19	070927	Foot, WFE Pump	K9390
20	070929	Foot Insert for WFE Pump	K9391
21	071657	Screw, 1/4 - 20 x 1" (2 needed)	K9393*
22	071406	Nut, 1/4" - 20 Hex Head S.S. (2 needed)	K9394*
23	072183	Flat Washer, 1/4" x 5/8" (2 needed)	K9529
24	071131	Drain Plug Knob (2 needed)	K9396
25	074629	Gasket, Flat Washer (2 needed)	K9607
26	357149	Volute Replacement Kit (after 11-98)	K9371
27	---	Motor, Square Flange (See Motor Replacement Pages 217-219)	---
28	073126	Impeller, 1/2 HP (WFE-2)	K9402
28	073127	Impeller, 3/4 HP (WFE-3), (WF-3 & WF-24)	K9404
28	073128	Impeller, 1 HP (WFE-4), (WF-4 & WF-26)	K9405
28	073129	Impeller, 1-1/2 HP (WFE-6), (WF-6, WF-28, WFDS-6 & WFDS-28)	K9407
28	073130	Impeller, 2 HP (WFE-8), (WF-8, WF-30, WFDS-8 & WFDS-30)	K9409
28	073131	Impeller, 3 HP (WFE-12)	K9410
---	Go Kit 32	Pump Repair Kit (Gaskets & Seal)	K6059

*Non-Stock Item

PENTAIR / STA-RITE DURA-GLAS & MAX-E-GLAS PUMPS "P2R", "P2RA", "PE" & "PEA"

Complete Product on Page 148

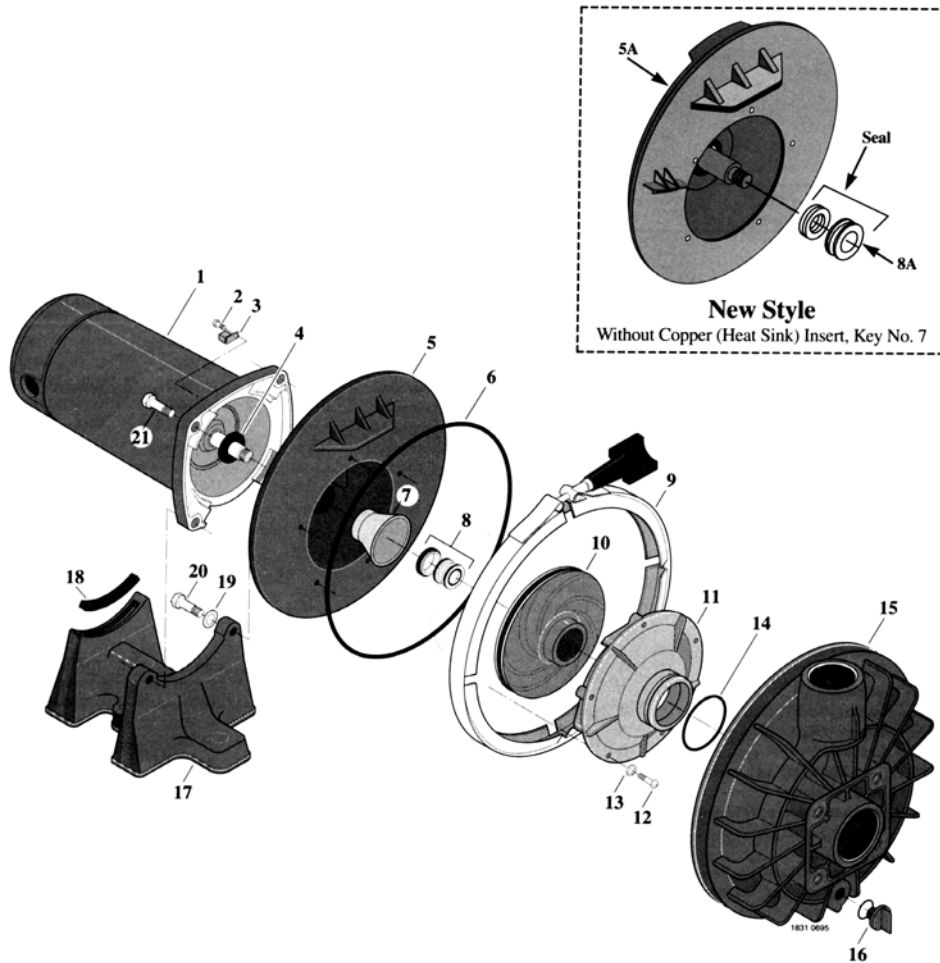

KEY	MFG NO.	DESCRIPTION	ITEM NO.
1	-----	Motor, Square Flanged (See Motor Pages 217-219)	----
2	U30-692SS	Screw, 10 - 32 x 1/2"	
3	U17-568	Bonding Lug	K3300*
4	C69-2	Water Slinger	K3500
5	C203-137P1	Seal Plate w/Copper Insert (Replaced by #C203-193P Kit)	N/A
5	C203-193P	Seal Plate w/o Copper Insert (1998 - Present)	K3402
6	U9-228A	O-Ring	K3404
7	J3-2	Copper Insert (if required)	K3406
8	U109-93SS	Shaft Seal for Seal Plate w/ Copper Insert (#100)	K6024
8A	17304-0100S	Shaft Seal for Seal Plate w/out Copper Insert	K3415
9	C19-37A	Clamp	K3485
---	WC36-22	Clamp Knob	H5308
10	C105-92PR	Impeller, 1/2 HP, Up-Rated (P2RA5C)	K3408
10	C105-92PS	Impeller, 1/2 HP, Full Rated (PE5C, PE6C, PE52C, P2R5C)	K3410
10	C105-92PS	Impeller, 3/4 HP, Up-Rated (PEA5D, PEA6D, P2RA5D)	K3410
10	C105-138PEB	Impeller, 3/4 HP, Full Rated (PE5D, PE6D, PE52D, P2R5YD)	K3412

*Non-Stock Item

STA-RITE DURA-GLAS & MAX-E-GLAS PUMPS
“P2R”, “P2RA”, “PE” & “PEA”

Complete
Product on
Page 148

KEY	MFG NO.	DESCRIPTION	ITEM NO.
10	C105-138PEB	Impeller, 1 HP, Up-Rated (P2RA5YE, PEA5E, PEA6E, P2RA5E)	K3412
10	C105-137PEB	Impeller, 1 HP, Full Rated (PE5E, PE6E, PE52E, P2R5YE, P2R5E)	K3414
10	C105-137PEB	Impeller, 1-1/2 HP, Up-Rated (PEA5F, PEA6F, P2RA5F, P2RA6F)	K3414
10	C105-137PDBA	Impeller, 1-1/2 HP, Full Rated (PE5F, PE6F, PE52F, P2R5F, P2R5YF, PWR52F3, P2R5F3)	K3453
10	C105-137PEBA	Impeller, 1-1/2 - 1/4 2-Speed Full Rated (P2R52E3, P2R5E3)	K3451
10	C105-137PEBA	Impeller, 1-1/2 - 1/4 2-Speed Up-Rated (PEA52F, P2RA5YF)	K3451
10	C105-137PDBA	Impeller, 2 HP, Up-Rated (PEA5G, PEA6G, PEA52G, P2RA5G, P2RA6G, P2RA5YG, P2RA6YG)	K3453
10	C105-137PDA	Impeller, 2 HP, Full Rated (PE5G, PE6G, PE52G, P2R52G3)	K3416
10	C105-137PDA	Impeller, 2-1/2 HP Up-Rated (PEAA5G, PEAA6G)	K3416
10	C105-137PKBA	Impeller, 3 HP (PE6H, PE62H, PE6H3)	K3417
---	C30-12	Impeller Screw (for all pumps using 3-phase motor)	K3314
11	C1-217P	Diffuser, 1/2 HP - Up-rated	K3418
11	C1-216P	Diffuser, 1/2 HP - Full	K3420
11	C1-216P	Diffuser, 3/4 HP - Up-rated	K3420
11	C1-200PA	Diffuser, 3/4 - 2-1/2 HP - Full	K3422
11	C1-200PA	Diffuser, 1 - 2-1/2 HP - Up-rated	K3422
11	C1-259P	Diffuser, 3 HP - Full	K3555*
12	U30-542SS	Screw, 8 - 32 x 7/8"	K3444
13	U43-21SS	Washer, # 8 Lock	K3446
14	U9-226	Diffuser O-Ring	K3426
15	C176-47P1	Tank Body	K3430
16	U178-920P	Drain Plug 1/4" NPT w/ O-Ring	K3439
17	C104-42P	Base w/ Motor Pad	K3448
17	C104-41P	Base w/ Motor Pad (3 HP Only)	K3450*
18	C35-11	Motor Pad	K3454
19	U43-42SS	Washer, Flat	K3456
20	U30-77SS	Capscrew, 3/8 - 16 x 1-3/4" Hex Head	K3452
20	U30-778SS	Capscrew, 3/8 - 16 x 1-3/4" Soc. Head (3 HP Only)	K3557*
21	U30-74SS	Capscrew, 3/8 - 16 x 1" Hex Head	K3458
21	U30-99SS	Capscrew, 3/8 - 16 x 1" Soc. Head (3 HP Only)	K3559*

*Non-Stock Item

PENTAIR EQ SERIES COMMERCIAL PLASTIC PUMPS HAIR AND LINT STRAINER REPLACEMENT PARTS

Complete
Product on
Page 106

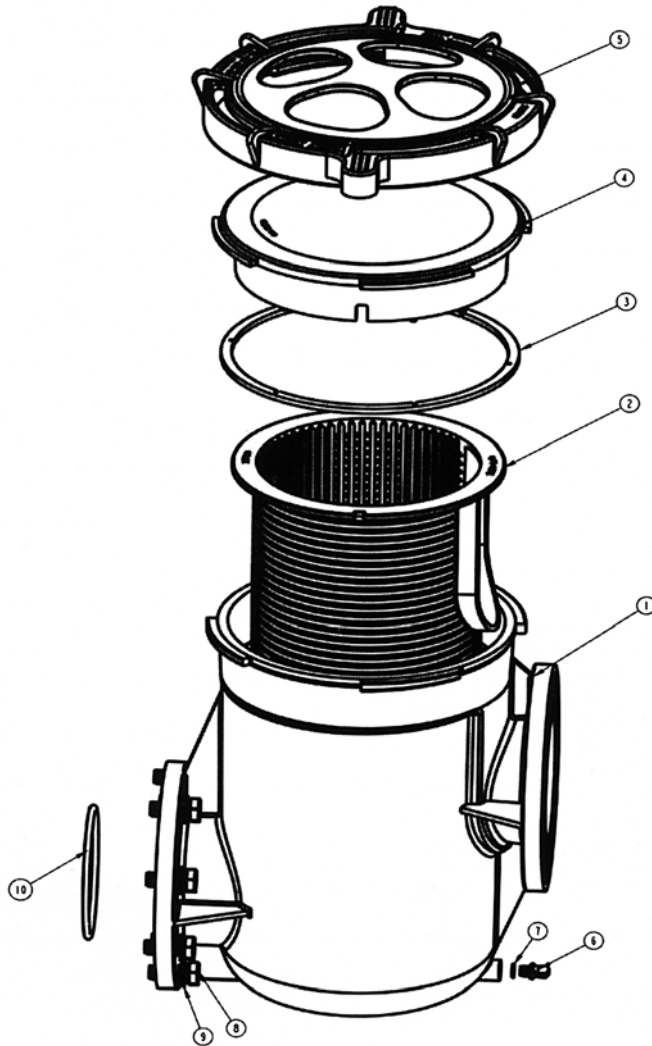

KEY	MFG NO.	DESCRIPTION	ITEM NO.
1	356725	Pot EQ Strainer	*
2	357184	Basket EQ Strainer	K3733
3	350166	Gasket, EQ lid	*
4	356750	Lid EQ clear	*
5	350171	Clamp Cam & Ramp EQ	*
6	154699	Plug wire 0.25 in. drain LGR	H4312
7	192115	O-ring drain plug	H3274
8	356788	Screw, 5/8 in., 11 x 1-3/4 in. hx hd cap 18-8 SS (qty. 8)	*
9	356789	Washer, flat 11/16 in. ID x 1-5/16 in. OD 0.078 thk 300 SS (qty. 8)	*
10	356766	O-ring pot flange	*
	350087	Pressure relief valve, 1/4 in. flange (not shown)	*

Note: If you are replacing an orange lid _ring, please order a 350171 Locking ring/O-ring Kit

*Non-Stock Item

**PENTAIR EQ SERIES COMMERCIAL PLASTIC PUMPS
REPLACEMENT PARTS**

Complete
Product on
Page 106

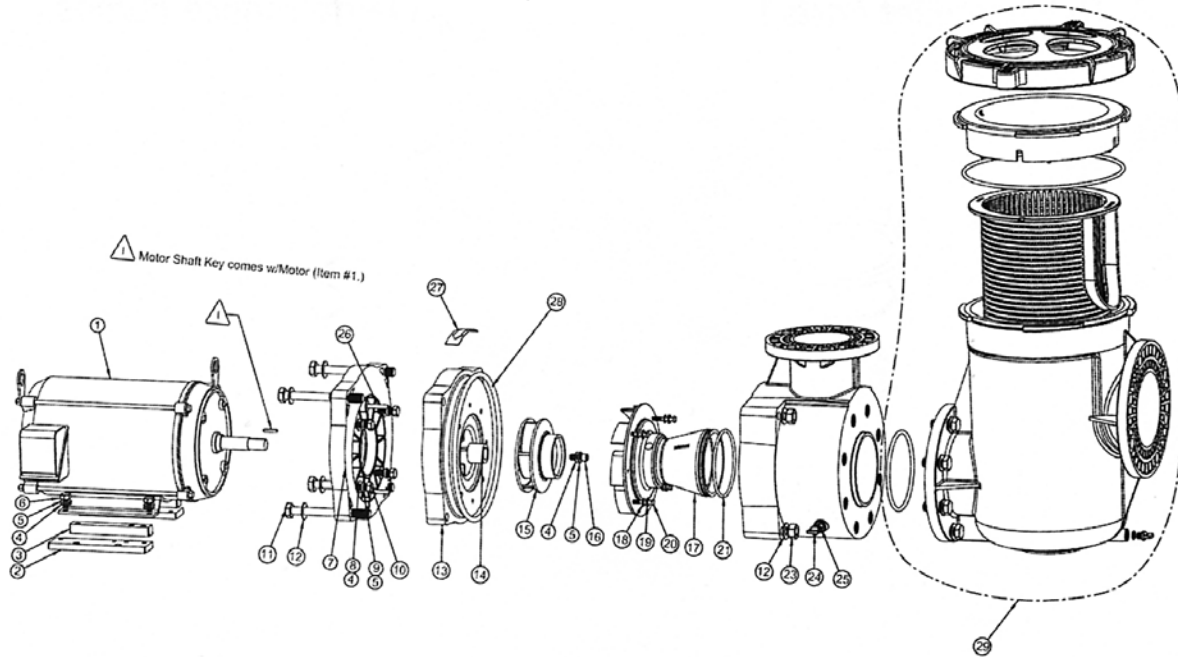

KEY	MFG NO.	DESCRIPTION	Item No.
1	357071	Motor 15 HP 3 Phase - EQ1500 - 60 Hz	*
1	357070	Motor 10 HP 3 Phase - EQ1000 - 60 Hz	*
1	357069	Motor 7½ HP 3 Phase - EQ750 - 60 Hz	*
1	357066	Motor 7½ HP 1 Phase - EQ750 - 60 Hz	*
1	357068	Motor 5 HP 3 Phase - EQ500 - 60 Hz	*
1	357065	Motor 5 HP 1 Phase - EQ500 - 60 Hz	*
1	357067	Motor 3 HP 3 Phase - EQW300 - 60 Hz	*
1	357064	Motor 3 HP 1 Phase - EQW300 - 60 Hz	*
1	350158	Motor 5 HP 3 Phase - EQW500 - 60 Hz	*
1	350159	Motor 5 HP 1 Phase - EQW500 - 60 Hz	*
1	350112	Motor Expin PF 10 HP 3 Phase - EQK1000 - 50 Hz	*
1	350113	Motor Expin PF 7½ HP 3 Phase - EQK1000 - 50 Hz	*
1	350153	Motor 10 HP 3 Phase - EQK1000 - 50 Hz	*
1	350154	Motor 7½ HP 3 Phase - EQK750 - 50 Hz	*
1	350155	Motor 5 HP 3 Phase - EQK500 - 50 Hz	*
1	350156	Motor 3 HP 3 Phase - EQK300 - 50 Hz	*
2	356713	Support - Motor {qty. 2}	K4700
3	356712	Support Adapter - Motor - EQW300, EQ500, EQ750 ...3PH {qty.2}	K4701
4	072184	Washer, Flat 3/8" ID x 7/8" OD .05 Thk 18-8 s/s {qty. 5 ¹ & qty. 9}	K3828
5	98220600	Washer Split Lock 3/8" 1-8 s/s {qty. 5 ¹ & qty. 9}	K4702

*Non-Stock Item

**PENTAIR EQ SERIES COMMERCIAL PLASTIC PUMPS
REPLACEMENT PARTS**

KEY	MFG NO.	DESCRIPTION	Item No.
6	A135	Screw 3/8" - 16x3/4 Hx Hd Cap 18-8 s/s (EQ750...1PH, EQ1000, EQ1500) {qty. 4}	K4703
6	350073	Screw 3/8" - 16 x 1½ Hx Hd Cap 18-8 s/s (EQ300, EQ500, EQ750...3PH0 {qty. 4}	K4704
7	356790	Adapter - Motor - EQ Series	K4705
8	075842	Washer, Flat ½" ID x 1¼" OD .125 Thk 300 s/s {qty. 4}	K4706
9	350063	Washer Split Lock ½" 18-8 s/s {qty. 4}	K4707
10	354290	Screw 3/8" - 16 x 1" Hx Hd Cap 18-8 s/s (EQ300, EQ500, EQ750...3PH) {qty. 4}	K4548
10	075843	Screw ½" - 13 x 1¼" Hx Hd Cap 18-8 s/s (EQ750, 1PH, EQ1000, EQ1500) {qty. 4}	K4708
11	356710	Screw 5/8" 11 x 6½" Hx Hd Cap 18-8 s/s {qty. 4}	K4709
12	356789	Washer, Flat 11/16" IDx1 - 5/16" OD .078 Thk 300 s/s {qty. 8}	K4710
13	356795	Seal Plate - EQ Series	K4711
14	071725	Seal Set	K9431
15	350030	Impeller Assy. - EQ500	K4712
15	350029	Impeller Assy. - EQ750	K4713
15	350028	Impeller Assy. - EQ1000	K4714
15	350027	Impeller Assy. - EQW300, EQ1500	K4715
15	350070	Impeller Assy. - EQW500	K4716
16	071037	Screw 3/8"-16 x 1" Sckt. Hd Cap 18-8 s/s	K9397
17	350032	Diffuser - EQ500	K4717
17	350033	Diffuser - EQ750, EQ1000	K4718
17	356735	Diffuser - EQW300, EQ1500	K4719
17	357273	Diffuser - EQW500	k4720
18	51008500	Washer, Flat ¼" 300 s/s {qty. 4}	K3898
19	072172	Washer, Split Lock ¼" 18-8 s/s {qty. 4}	K4721
20	350035	Screw ¼"-20 x 1½" Hx Hd Cap 18-8 s/s (EQ500, EQ750, EQ1000) {qty. 4}	K4722
20	356797	Screw ¼"-20 x 1¾" Hx Hd Cap 18-8 s/s (EQW300, EQ1500) {qty. 4}	K4723
21	350037	O-ring Diffuser 3/16" x 4-7/8	K4724
22	356755	Housing - EQ Series	K4725
23	356776	Nut 5/8" - 11 Hx Brass {qty. 5}	K4726
24	154699	Drain Plug	H4312B
25	192115	O-ring Drain Plug	H3274
26	350060	Pin Dowel 5/16" x 1¾" 18-8 s/s {qty. 2}	K4727
27	350072	Label, Directional Arrow	*
28	356780	O-ring Seal Plate 3/8" x 11" dia.	K4728
29	340013	Strainer Pot, Complete EQ 6" x 6"	K3735

*Non-Stock Item

Hayward Comfortzone PSG-II, 110-355	391-393
Hayward H-Series	395-399
Jandy Lite II LJ	400-404
Jandy LX	405-409
Pentair MasterTemp	410-411
Pentair Purex (Pac-Fab) Minimax Plus	412-415
Pentair MiniMax NT STD Heater	416-418
Raypak RP2100, Metal Headers	419-422
Raypak RP2100, Capron Headers	423-427
Teledyne Laars EPG, EPM Series 1	428-430
Teledyne Laars Lite Gas Heaters	431-436

HAYWARD COMFORTZONE PSG-II 110-355 HEATERS

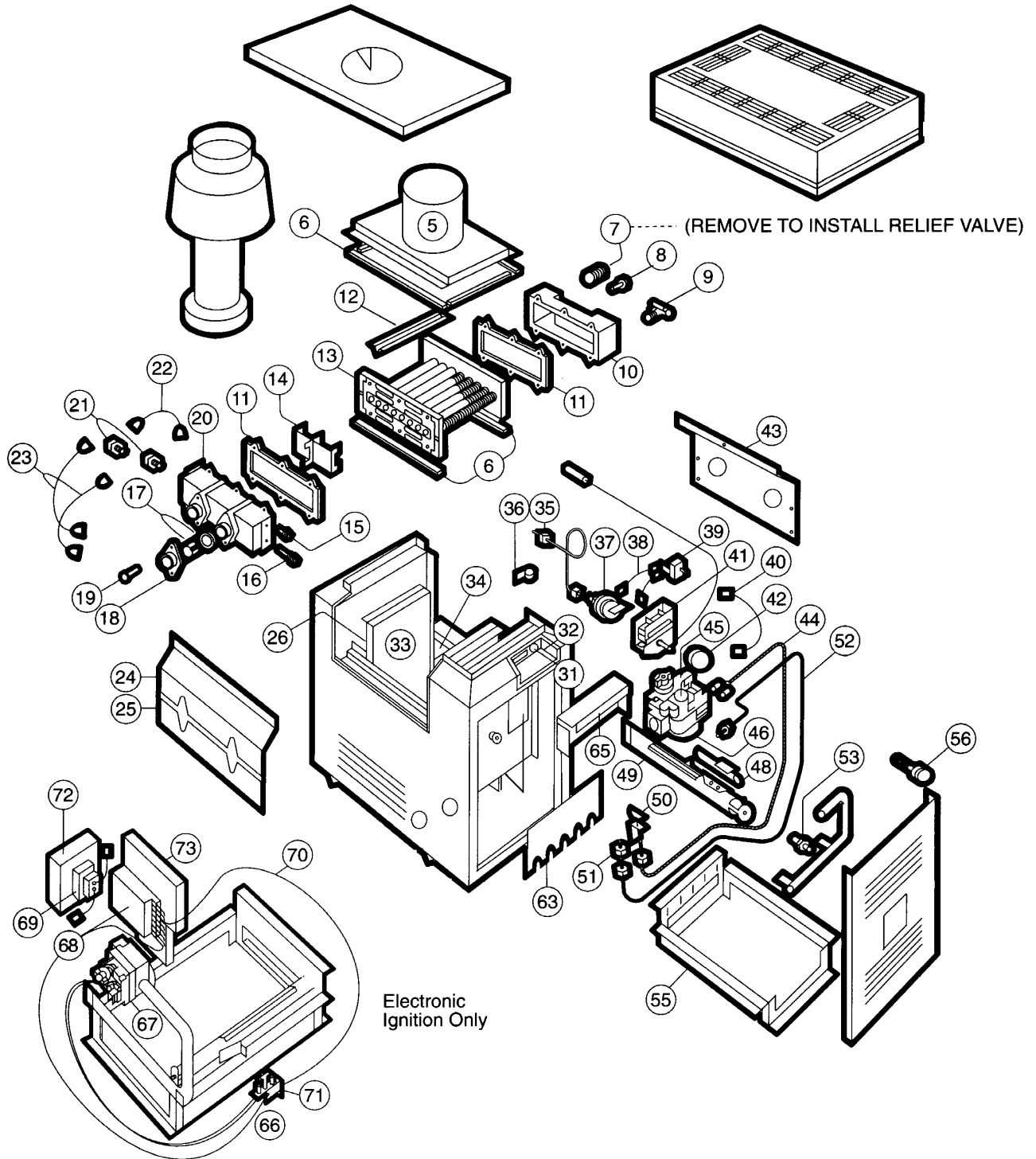

HAYWARD COMFORTZONE PSG-II 110-355 HEATERS

KEY	MFG NO.	DESCRIPTION	ITEM NO.
5	CZXFCA3330	Flue Collector Assembly (110)	OBS
5	CZXFCA3331	Flue Collector Assembly (150)	OBS
5	CZXFCA3332	Flue Collector Assembly (180)	OBS
5	CZXFCA3333	Flue Collector Assembly (215)	OBS
5	CZXFCA3334	Flue Collector Assembly (255)	OBS
5	CZXFCA3335	Flue Collector Assembly (355)	OBS
6	CZXINS0001	Kaowool Insulation 100"	J2478
7	CHXPLG1930	3/4" Brass Drain Plug	J3700
8	CZXBLT6603	Header Bolts (6 pcs)	J2480
9	CZXDRV6802	Drain Valve 3/4"	OBS
7-9-10	CZXBKT7051	Rear Bucket Assembly (Excluding Gasket)	OBS
11	CZXGKT7401	Bucket Gasket, Set of 2	J2401
12	CZXBFL3007	"V" Baffles 110 (6 pcs)	OBS
12	CZXBFL3008	"V" Baffles 150 (6 pcs)	OBS
12	CZXBFL3009	"V" Baffles 180 (6 pcs)	OBS
12	CZXBFL3010	"V" Baffles 215 (6 pcs)	OBS
12	CZXBFL3011	"V" Baffles 255 (6 pcs)	OBS
12	CZXBFL3012	"V" Baffles 355 (6 pcs)	OBS
13	CZXHEX7106	Heat Exchanger Only (110)	OBS
13	CZXHEX7107	Heat Exchanger Only (150)	J2490+
13	CZXHEX7108	Heat Exchanger Only (180)	OBS
13	CZXHEX7109	Heat Exchanger Only (215)	OBS
13	CZXHEX7110	Heat Exchanger Only (255)	OBS
13	CZXHEX7111	Heat Exchanger Only (355)	OBS
14	CZXBYP6812	One Piece By-Pass	J2491+
15	CHXPSA1930	Pressure Switch Adaptor	J2492
16	CHXTBW1930	Thermostat Bulb Well	J2493
17	CZXGKT7406	Flange Compression Gasket, Set of 2	J2407+
19	CZXBKT7003	Flanges, Set of 2	OBS
19	CZXBLT6604	Flange Bolts (4 pcs)	J2495+
20	CZXBKT7048	Front Bucket Only	J2784+
21	CZXHLI9402	Immersion Hi-Limit (Single Unit)	J2402+
14-22	CZXBKT7050	Front Bucket Assembly	OBS
22	CZXWIR6605	Hi-Limit Jumper Wire	J2786+
23	CZXWIR6606	Hi-Limit Lead Wire	J2787+
7-22	CZXHEX7112	Heat Exchanger Assembly - Complete (110)	OBS
7-22	CZXHEX7113	Heat Exchanger Assembly - Complete (150)	OBS
7-22	CZXHEX7114	Heat Exchanger Assembly - Complete (180)	OBS
7-22	CZXHEX7115	Heat Exchanger Assembly - Complete (215)	OBS
7-22	CZXHEX7116	Heat Exchanger Assembly - Complete (255)	OBS
7-22	CZXHEX7117	Heat Exchanger Assembly - Complete (355)	OBS
24	CZXJKT5201	Upper Front Access Cover (All Models)	OBS
25	CZXJKT4901	Lower Front Access Cover (All Models)	OBS
26	CZXINS0019	Insulation Blanket	OBS
31	CZXTDL0102	Thermostat Dial Lock	J2535+
32	CZXCPA2808	Control Panel Assembly	OBS

+ Limited Quantities
*Non-Stock Item

HAYWARD COMFORTZONE PSG-II 110-355 HEATERS

KEY	MFG NO.	DESCRIPTION	ITEM NO.
33	CZXINS0005	FireTile Front/Rear (110) Each	OBS
33	CZXINS0006	FireTile Front/Rear (150) Each	OBS
33	CZXINS0007	FireTile Front/Rear (180) Each	OBS
33	CZXINS0008	FireTile Front/Rear (215) Each	OBS
33	CZXINS0009	FireTile Front/Rear (255) Each	OBS
33	CZXINS0010	FireTile Front/Rear (355) Each	OBS
34	CZXINS0011	FireTile Side - Common	OBS
35	CHXPST1200	Pressure Switch Tube with Fittings	OBS
36	CZXPSC1930	Pressure Switch Tube Clamp (Old # CZXPSC6402)	OBS
37	CHXPRS1931	Pressure Switch	J2403
38	CZXWIR6502	"On/Off" Switch Wires	OBS
39	CZXTSW1904	"On/Off" Switch	J2411+
40	CZXWIR6500	Control Wire	OBS
41	CZXTST1907	Thermostat	J2404+
42	CZXTSK2003	Thermostat Knob	J2508
43	CZXJKT5101	Rear Access Cover	OBS
44	CHXGEN1930	Pilot Generator	J2400
46	CHXVAL1931	Gas Valve - MV, Natural Gas (110 thru 355)	J2405
46	CHXVAL1932	Gas Valve - MV, Propane (110 thru 355)	J2406
48	CZXEZL2303	E-Z Lite Tube	OBS
49	CZXBNR2314	Main Burner with Bracket	OBS
49A	CZXBNR2315	Main Burner	J2566+
50	CZXPBR0806	Pilot Burner, Natural Gas (Honeywell)	OBS
50	CZXPBR0807	Pilot Burner, Propane (Honeywell)	OBS
51	CZXORF0508	Pilot Orifice, Natural Gas (Honeywell)	J2443+
51	CZXORF0509	Pilot Orifice, Propane (Honeywell)	OBS
52	CZXPTB0900	Pilot Tube with Fittings	J2445+
53	CZXORF0611	Main Burner Orifice, Propane	OBS
55	CZXBNR4020	Burner Tray Frame Only (110) (Old # CZXBNR3906)	OBS
55	CZXBNR4021	Burner Tray Frame Only (150) (Old # CZXBNR3907)	OBS
55	CZXBNR4022	Burner Tray Frame Only (180) (Old # CZXBNR3908)	OBS
55	CZXBNR4023	Burner Tray Frame Only (215) (Old # CZXBNR3909)	OBS
55	CZXBNR4024	Burner Tray Frame Only (255) (Old # CZXBNR3910)	OBS
55	CZXBNR4025	Burner Tray Frame Only (355) (Old # CZXBNR3911)	OBS
44-55	CZXBDA3310	Burner Drawer Assy - Complete (110) Natural Gas	OBS
44-55	CZXBDA3317	Burner Drawer Assy - Complete (110) Propane	OBS
44-55	CZXBDA3311	Burner Drawer Assy - Complete (150) Natural Gas	OBS
44-55	CZXBDA3318	Burner Drawer Assy - Complete (150) Propane	OBS

+ Limited Quantities

HAYWARD COMFORTZONE PSG-II 110-355 HEATERS

KEY	MFG NO.	DESCRIPTION	ITEM NO.
44-55	CZXBDA3312	Burner Drawer Assy - Complete (180) Natural Gas	OBS
44-55	CZXBDA4134	Burner Drawer Assy - Complete (180) Propane	OBS
44-55	CZXBDA3313	Burner Drawer Assy - Complete (215) Natural Gas	OBS
44-55	CZXBDA3320	Burner Drawer Assy - Complete (215) Propane	OBS
44-55	CZXBDA4130	Burner Drawer Assy - Complete (255) Natural Gas	OBS
44-55	CZXBDA3321	Burner Drawer Assy - Complete (255) Propane	OBS
44-55	CZXBDA3315	Burner Drawer Assy - Complete (355) Natural Gas	OBS
44-55	CZXBDA3322	Burner Drawer Assy - Complete (355) Propane	OBS
56	CHXDSW1930	Knurled Head Door Screw	OBS
63	CZXFLG0906	Flame Guard (110)	OBS
63	CZXFLG0905	Flame Guard (150)	OBS
63	CZXFLG0904	Flame Guard (180)	OBS
63	CZXFLG0903	Flame Guard (215)	OBS
63	CZXFLG0902	Flame Guard (255)	OBS
63	CZXFLG0901	Flame Guard (355)	OBS
65	CZXJCB0706	Control Box Cover (110 - 180)	OBS
65	CZXJCB0707	Control Box Cover (215 - 355)	OBS
66	CZXPBR0816	Pilot Burner Natural IID (Electronic)	J2428+
66	CZXPBR0713	Pilot Burner Propane IID (Electronic)	OBS
67	CHXVAL1933	Gas Valve IID, Natural Gas (Electronic)	J2448+
67	CHXVAL1934	Gas Valve IID, Propane (Electronic)	J2449+
68	CHXMOD1931	Ignition Module	J2442+
68	CHXMOD1932	Ignition Module RS (Propane Only)	J2722+
69	CZXTRF4002	Transformer	OBS
70	CZXWIR6506	Sensor Wire	J2818+
71	CZXFLS0823	Flame Sensor	J2436+
72	CZXJBX3205	Junction Box Assembly	OBS
73	CZXMMB4604	Module Mounting Bracket	OBS
--	CZXBDA3956	IID Burner Drawer Assembly (110)	OBS
--	CZXBDA3957	IID Burner Drawer Assembly (150)	OBS
--	CZXBDA3958	IID Burner Drawer Assembly (180)	OBS
--	CZXBDA3959	IID Burner Drawer Assembly (215)	OBS
--	CZXBDA3960	IID Burner Drawer Assembly (255)	OBS
--	CZXBDA3961	IID Burner Drawer Assembly (355)	OBS
--	CZXCNK5922	Conversion Kit - Propane to Natural Gas	OBS
--	CZXCNK5923	Conversion Kit - Natural Gas to Propane	J2431+
--	CHXRLV1930	Relief Valve	J2424
--	CZXPNY1930	Touch-Up Paint, Pewter Grey	OBS
--	CZXTPG2912	Touch-Up Paint, Charcoal Grey	OBS
--	CZXDTK1907	Dual Thermostat Kit	J2433+

+ Limited Quantities

HAYWARD H - SERIES HEATERS

Series
H150
H200
H250
H300
H350
H400

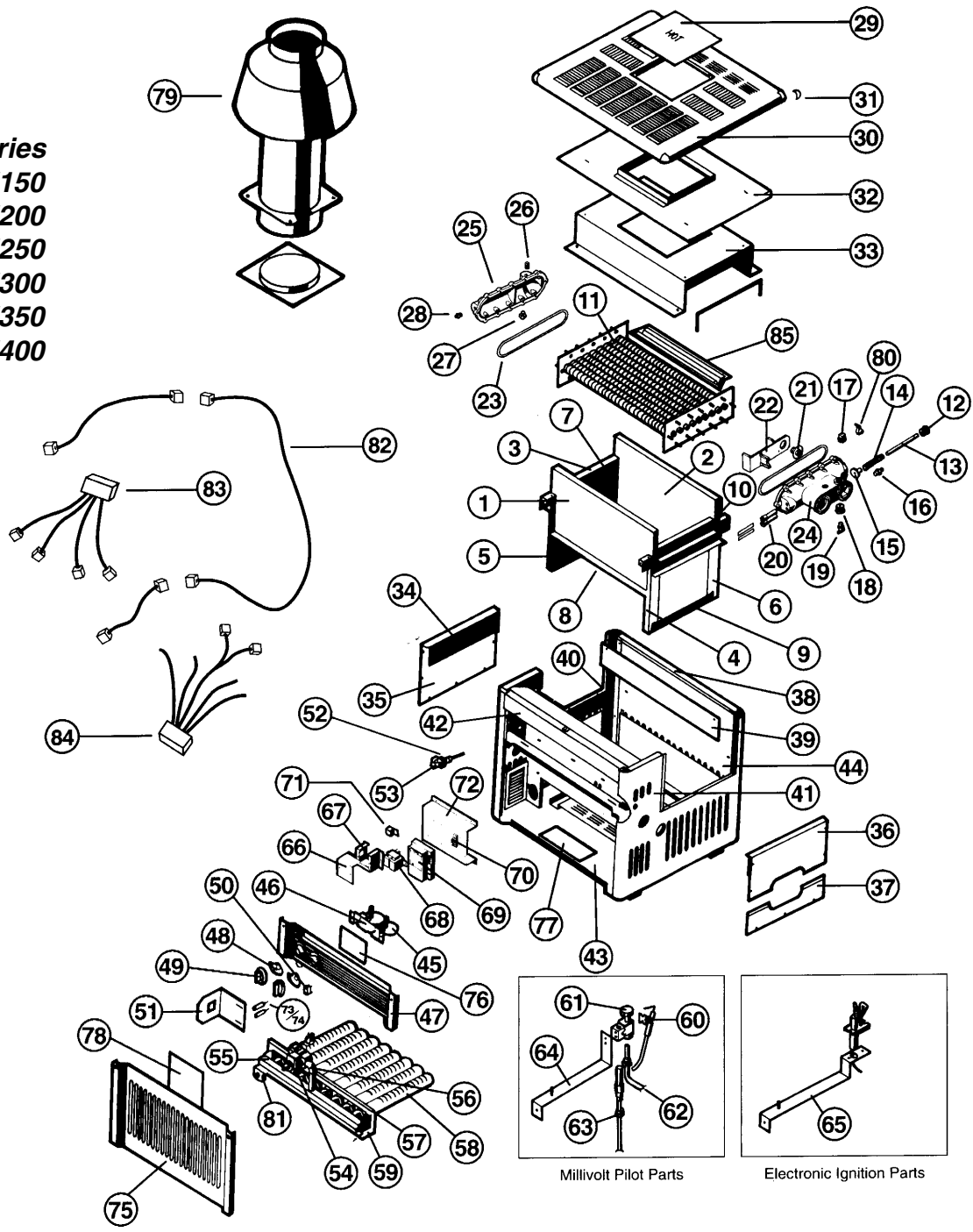

KEY	MFG. NO.
30	HAXJKT1150
30	HAXJKT1200
30	HAXJKT1250
30	HAXJKT1300
30	HAXJKT1350
30	HAXJKT1400
31	HAXCIA1930

DESCRIPTION
Jacket Top - 150
Jacket Top - 200
Jacket Top - 250
Jacket Top - 300
Jacket Top - 350
Jacket Top - 400
Corner Insert Assembly

ITEM NO.
J3722*
J3724*
J3726*
J3728*
J3730*
J3732*
J3734*

*Non-Stock Item

HAYWARD H - SERIES HEATERS

KEY	MFG. NO.	DESCRIPTION	ITEM NO.
1	HAXFTF1150	Front HeatLock - 150	OBS
1	HAXFTF1200	Front HeatLock - 200	OBS
1	HAXFTF1250	Front HeatLock - 250	OBS
1	HAXFTF1300	Front HeatLock - 300	OBS
1	HAXFTF1350	Front HeatLock - 350	OBS
1	HAXFTF1400	Front HeatLock - 400	OBS
2	HAXFTB1150	Rear HeatLock - 150	OBS
2	HAXFTB1200	Rear HeatLock - 200	OBS
2	HAXFTB1250	Rear HeatLock - 250	OBS
2	HAXFTB1300	Rear HeatLock - 300	OBS
2	HAXFTB1350	Rear HeatLock - 350	OBS
2	HAXFTB1400	Rear HeatLock - 400	OBS
3	HAXFTS1930	Side HeatLock - All	J3654*
4	HAXRFA1930	Combustion Chamber Angle, Rt. Front - All	OBS
5	HAXLFA1930	Combustion Chamber Angle, Lt. Front - All	OBS
6	HAXRRA1930	Combustion Chamber Angle, Rt. Rear - All	OBS
7	HAXLRA1930	Combustion Chamber Angle, Lt. Rear - All	OBS
8	HAXFRC1150	Channel F/R 150	OBS
8	HAXFRC1200	Channel F/R 200	OBS
8	HAXFRC1250	Channel F/R 250	OBS
8	HAXFRC1300	Channel F/R 300	OBS
8	HAXFRC1350	Channel F/R 350	OBS
8	HAXFRC1400	Channel F/R 400	OBS
9	HAXLSC1930	Lower Side Channel (2 pieces) - All	OBS
10	HAXSHS1930	Side Heat Exchanger Support (2 pieces) - All	OBS
11	HAXHEX1150	Heat Exchanger Only - 150	OBS
11	HAXHEX1200	Heat Exchanger Only - 200	OBS
11	HAXHEX1250	Heat Exchanger Only - 250	OBS
11	HAXHEX1300	Heat Exchanger Only - 300	OBS
11	HAXHEX1350	Heat Exchanger Only - 350	OBS
11	HAXHEX1400	Heat Exchanger Only - 400	OBS
12	HAXADP1930	Brass Adapter	OBS
13	HAXSFT1930	Brass Shaft	OBS
14	HAXVSG1930	Valve Spring	OBS
15	HAXBPV1930	By-Pass Valve	OBS
16	HMXHLI2931	Hi-Limit	J3510+
17	CHXPLG1930	3/4" NPT Brass Plug	J3700
18	CHXBSh1930	1/4" - 3/4" Brass Bushing	J3702*
19	CHXDRV1930	Drain Valve	OBS
20	CHXTBW1930	Bulb Well	J2493
21	HAXFCT1930	Flow Control Thermostat	J3706*
22	HAXBPI1930	By-Pass Valve Insert	OBS
23	HAXHOR1930	Header O-Ring	J3710
24	HAXFHD1930	Front Header - Only	J3712*
25	HAXRHD1930	Rear Header - Only	J3714
26	HAXPLG1930	1/4" NPT Brass Plug	J3716*
27	HMXHLI2932	Immersion Hi-Limit Rear Header 160 Degrees	J3511
28	CHXPSA1930	Pressure Switch Adapter	J2492
29	HAXDHO1930	DHO Insert	J3720*

+ Limited Quantities
*Non-Stock Item

HAYWARD H - SERIES HEATERS

KEY	MFG. NO.	DESCRIPTION	ITEM NO.
32	HAXRGA1150	Rain Guard Assembly - 150	OBS
32	HAXRGA1200	Rain Guard Assembly - 200	OBS
32	HAXRGA1250	Rain Guard Assembly - 250	OBS
32	HAXRGA1300	Rain Guard Assembly - 300	OBS
32	HAXRGA1350	Rain Guard Assembly - 350	OBS
32	HAXRGA1400	Rain Guard Assembly - 400	OBS
33	HAXFCA1150	Flue Collector Assembly - 150	OBS
33	HAXFCA1200	Flue Collector Assembly - 200	OBS
33	HAXFCA1250	Flue Collector Assembly - 250	OBS
33	HAXFCA1300	Flue Collector Assembly - 300	OBS
33	HAXFCA1350	Flue Collector Assembly - 350	OBS
33	HAXFCA1400	Flue Collector Assembly - 400	OBS
34	HAXHSS1930	Side Heat Shield	OBS
35	HAXLAC1930	Left Access Cover	J3762*
36	HAXURA1930	Upper Right Access Cover	J3764*
37	HAXLRA1931	Lower Right Access Cover	J3766*
38	HAXDTF1930	Dart Type Fastener	OBS
39	HAXRHS1150	Rear Heat Shield - 150	OBS
39	HAXRHS1200	Rear Heat Shield - 200	OBS
39	HAXRHS1250	Rear Heat Shield - 250	OBS
39	HAXRHS1300	Rear Heat Shield - 300	OBS
39	HAXRHS1350	Rear Heat Shield - 350	OBS
39	HAXRHS1400	Rear Heat Shield - 400	OBS
40	HAXLSJ1930	Left Side Jacket Assembly	OBS
41	HAXRSJ1930	Right Side Jacket Assembly	OBS
42	HAXIPA1150	Intermediate Panel Assembly - 150	OBS
42	HAXIPA1200	Intermediate Panel Assembly - 200	OBS
42	HAXIPA1250	Intermediate Panel Assembly - 250	OBS
42	HAXIPA1300	Intermediate Panel Assembly - 300	OBS
42	HAXIPA1350	Intermediate Panel Assembly - 350	OBS
42	HAXIPA1400	Intermediate Panel Assembly - 400	OBS
43	HAXJBA1150	Jacket Bottom Assembly - 150	OBS
43	HAXJBA1200	Jacket Bottom Assembly - 200	OBS
43	HAXJBA1250	Jacket Bottom Assembly - 250	OBS
43	HAXJBA1300	Jacket Bottom Assembly - 300	OBS
43	HAXJBA1350	Jacket Bottom Assembly - 350	OBS
43	HAXJBA1400	Jacket Bottom Assembly - 400	OBS
44	HAXRJA1150	Rear Jacket Assembly - 150	OBS
44	HAXRJA1200	Rear Jacket Assembly - 200	OBS
44	HAXRJA1250	Rear Jacket Assembly - 250	OBS
44	HAXRJA1300	Rear Jacket Assembly - 300	OBS
44	HAXRJA1350	Rear Jacket Assembly - 350	OBS
44	HAXRJA1400	Rear Jacket Assembly - 400	OBS
45	CHXTST1930	Thermostat	J2457
46	HAXTMB1933	Thermostat Mounting Bracket	OBS
47	HAXCPA1150	Control Panel Assembly - 150 MV	J3824*
47	HAXCPA1200	Control Panel Assembly - 200 MV	J3826*
47	HAXCPA1250	Control Panel Assembly - 250 MV	J3828*
47	HAXCPA1300	Control Panel Assembly - 300 MV	J3830*
47	HAXCPA1350	Control Panel Assembly - 350 MV	J3832*
47	HAXCPA1400	Control Panel Assembly - 400 MV	J3834*

*Non-Stock Item

HAYWARD H - SERIES HEATERS

KEY	MFG. NO.	DESCRIPTION	ITEM NO.
47	HAXCPA1151	Control Panel Assembly - 150 DS	J3836*
47	HAXCPA1201	Control Panel Assembly - 200 DS	J3838*
47	HAXCPA1251	Control Panel Assembly - 250 DS	J3840*
47	HAXCPA1301	Control Panel Assembly - 300 DS	J3842*
47	HAXCPA1351	Control Panel Assembly - 350 DS	J3844*
47	HAXCPA1401	Control Panel Assembly - 400 DS	J3846*
48	CHXTDL1930	Thermostat Lock Dial	OBS
49	CHXTSK1930	Thermostat Knob	J2458
50	CHXTSW1930	System Switch	J2462
51	HAXGVB0001	Gas Valve Bracket (150 - 400 NA, DS, LP)	OBS
51	HAXGVB0002	Gas Valve Bracket (150 - 400 MV, 150 - 400 LP MV)	OBS
52	CHXPST1930	Pressure Switch Tube	J2664+
53	CHXPRS1931	Pressure Switch	J2403
54	HAXGSV0001	Gas Valve 150 - 400 NA MV	J3500
54	HAXGSV0003	Gas Valve 150 - 400 LP MV	J3502
54	HAXGSV0004	Gas Valve 150 - 400 LP DS	J3503
54	HAXGSV0005	Gas Valve 150 - 400 NA DS	J3504
55	HAXMAN1150	Gas Manifold - 150	J3858*
55	HAXMAN1200	Gas Manifold - 200	J3860*
55	HAXMAN1250	Gas Manifold - 250	J3862*
55	HAXMAN1300	Gas Manifold - 300	J3864*
55	HAXMAN1350	Gas Manifold - 350	J3866*
55	HAXMAN1400	Gas Manifold - 400	J3868*
56	HAXELL1930	3/4" Street Ell	OBS
57	HAXBON1930	Burner Orifice NA	J3872*
57	HAXBON1931	Burner Orifice NA HA	J3874*
57	HAXBOP1930	Burner Orifice LP	J3876*
57	HAXBOP1931	Burner Orifice LP HA	J3878*
58	HAXBRN1930	Burner Tube	J3880*
59	HAXBMB1150	Burner Mounting Bracket - 150	OBS
59	HAXBMB1200	Burner Mounting Bracket - 200	OBS
59	HAXBMB1250	Burner Mounting Bracket - 250	OBS
59	HAXBMB1300	Burner Mounting Bracket - 300	OBS
59	HAXBMB1350	Burner Mounting Bracket - 350	OBS
59	HAXBMB1400	Burner Mounting Bracket - 400	OBS
60	HAXPZE1930	Piezo Electrode	OBS
61	HAXPLT1931	Pilot - NA, MV	J3896*
62	HAXPLT1150	Pilot Tube - 150	OBS
62	HAXPLT1200	Pilot Tube - 200	OBS
62	HAXPLT1250	Pilot Tube - 250	OBS
62	HAXPLT1300	Pilot Tube - 300	OBS
62	HAXPLT1350	Pilot Tube - 350	OBS
62	HAXPLT1400	Pilot Tube - 400	OBS
63	CHXGEN1930	Pilot Generator	J2400
64	HAXPBA1930	Pilot Bracket Assembly	OBS
65	HAXIGN1930	Ignitor Bracket Assembly	OBS
66	HAXJBC1930	Junction Box Cover	OBS
67	HAXJCB1930	Junction Box	OBS
68	CHXTRF1930	Transformer	J2719
69	HAXMOD1930	Control Module	J3530

+ Limited Quantities
*Non-Stock Item

HAYWARD H - SERIES HEATERS

KEY	MFG. NO.	DESCRIPTION	ITEM NO.
70	HAXTMB1931	2 - Pole Terminal Block	OBS
70	HAXTMB1933	4 - Pole Terminal Block	OBS
71	CHXGRL1930	TA-2 Ground Block	OBS
72	HAXMMB1933	Module Mounting Bracket	OBS
73	HAXLDG1933	Green LED	OBS
74	HAXLDY1933	Yellow LED	OBS
75	HAXFAD1150	Front Access Door Assembly - 150	J3659*
75	HAXFAD1200	Front Access Door Assembly - 200	J3661*
75	HAXFAD1250	Front Access Door Assembly - 250	J3663*
75	HAXFAD1300	Front Access Door Assembly - 300	J3665*
75	HAXFAD1350	Front Access Door Assembly - 350	J3667*
75	HAXFAD1400	Front Access Door Assembly - 400	J3669*
76	HAXWDL1931	Wiring Diagram MV	OBS
76	HAXWDL1933	Wiring Diagram DS	OBS
77	HAXDAP1930	Data Plate	OBS
78	HAXLIS1930	Lighting Instructions	OBS
78	HAXOPR1930	Operating Instructions - MV	OBS
78	HAXOPR1933	Operating Instructions - DS	OBS
79	DHI150	Indoor Draffhood - 150	J2853*
79	DHI200	Indoor Draffhood - 200	J2854*
79	DHI250	Indoor Draffhood - 250	J2855*
79	DHI300	Indoor Draffhood - 300	J2856*
79	DHI350	Indoor Draffhood - 350	J3671*
79	DHI400	Indoor Draffhood - 400	J2859*
79	HWS150	High Wind Stack - 150	J2863*
79	HWS200	High Wind Stack - 200	J2864*
79	HWS250	High Wind Stack - 250	J2865*
79	HWS300	High Wind Stack - 300	J2866*
79	HWS350	High Wind Stack - 350	J3673*
79	HWS400	High Wind Stack - 400	J2869*
80	CHXRLV1930	Relief Valve	J2424
81	CHXMSI1930	Ignitor	J2575
82	HAXWHA0003	Wire Harness, Rear - Electronic	J3675*
82	HAXWHA0002	Wire Harness, Rear - MV	J3677*
83	HAXWHA0005	Wire Harness, Main - Electronic	J3679*
83	HAXWHA0001	Wire Harness, Main - MV	J3681*
84	HAXWHA0004	Wire Harness, Control Panel	J3683*
85	HAXBFL1150	V-Baffle - 150	OBS
85	HAXBFL1200	V-Baffle - 200	OBS
85	HAXBFL1250	V-Baffle - 250	OBS
85	HAXBFL1300	V-Baffle - 300	OBS
85	HAXBFL1350	V-Baffle - 350	OBS
85	HAXBFL1400	V-Baffle - 400	OBS

*Non-Stock Item

JANDY Lite 2 LJ (2003-Present)

Complete Product on Page 160

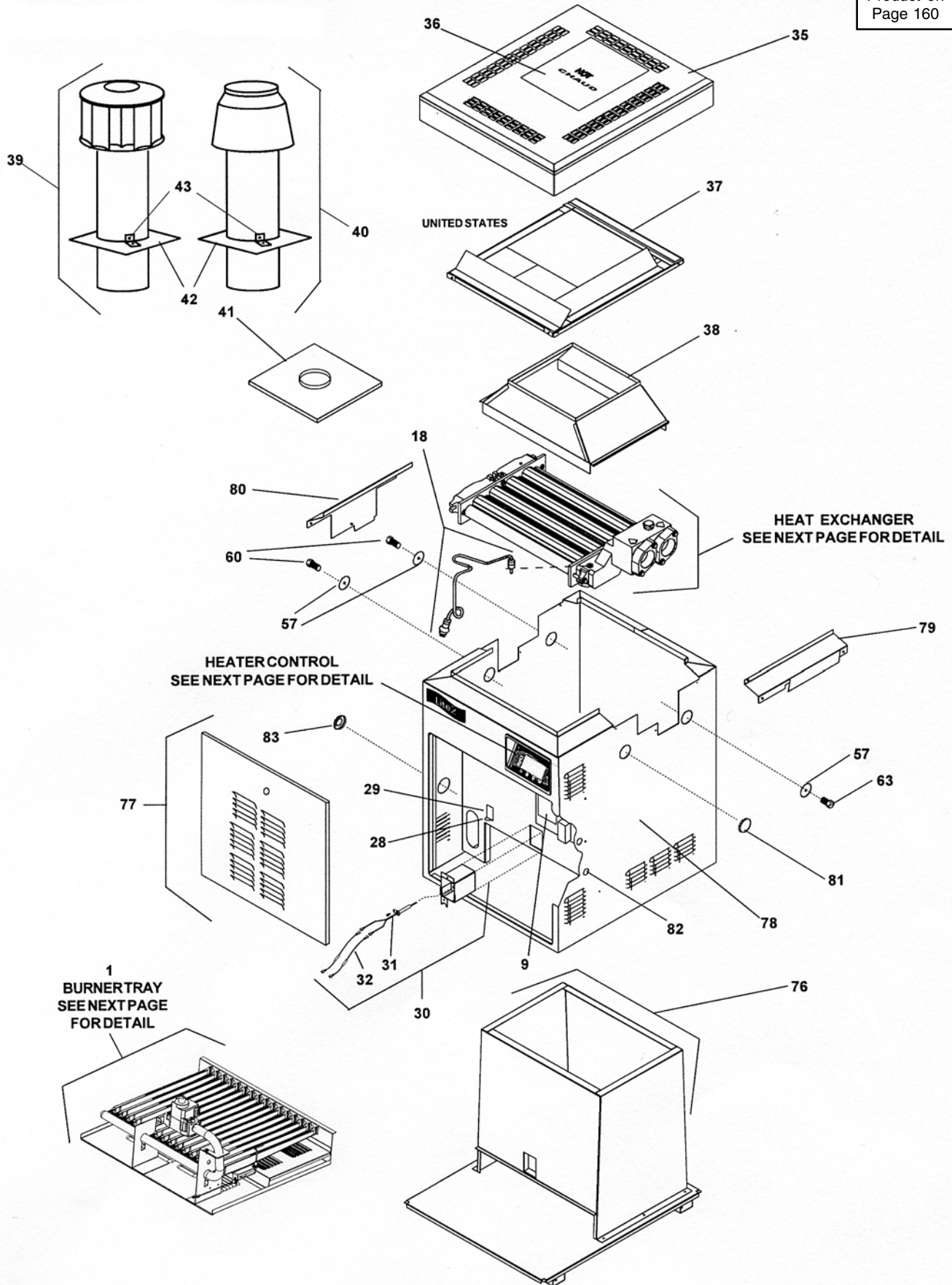

JANDY Lite2 LJ (Detail)

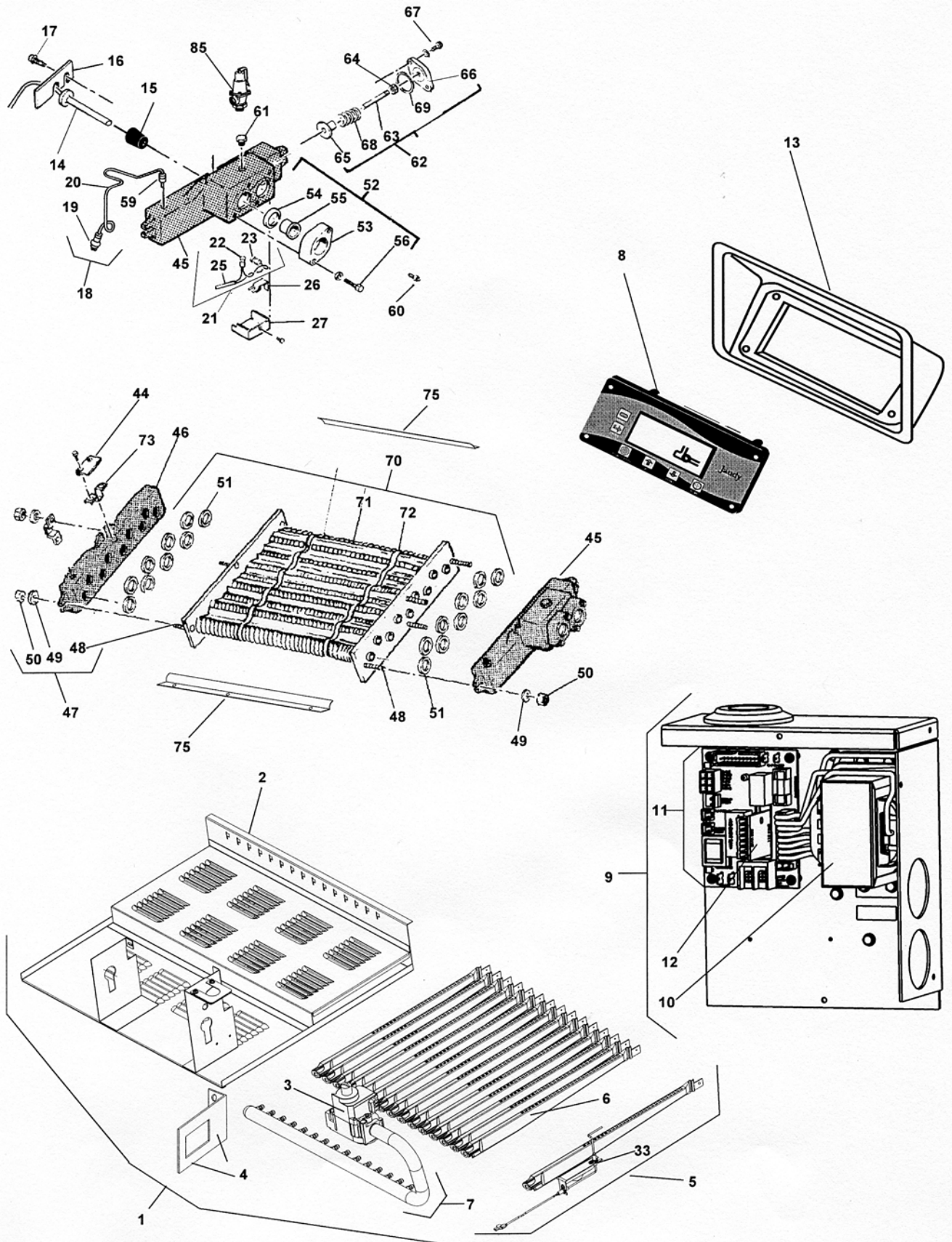

JANDY LITE2 LJ (MFG. 2003-PRESENT)

Key	Mfg#	Description	Item No.
MAIN GAS ASSEMBLY			
1	R0383601-05	Burner Tray Assy, NAT	*
1	R0383701-05	Burner Tray Assy, LPG	*
2	R0317001-05	Burner Tray, Shelf Only	*
3	R0317100	Gas Valve, NAT	J2880
3	R0319600	Gas Valve, LPG	J2882
4	L0032200	Gas Orifice, Nat 0-3,000 ft alt. (EA.)(Note 1)	J2076
4	L0032900	Gas Orifice, LPG 0-5,000 ft alt. (EA.)(Note 2)	J2078
5	10835900	Anti-Rotation Bracket	*
6	L0052300	Burner, Main	J2289
7	L0052200	Burner Manifold	*
7	L0006300	Burner Manifold	*
7	L0006400	Burner Manifold	*
7	L0006500	Burner Manifold	*
7	L0006600	Burner Manifold	*
ELECTRICAL SYSTEM			
8	R0366200	Heater Control Assembly	J2018
9	R0366500	High Voltage Assembly	*
10	R0366700	Transformer with Wiring Harness	J2014
11	R0366800	Power Control Board	J2015
12	R0366900	115/230 VAC Conversion Plug	J2016
13	S0069800	Bezel	*
14	R0367000	Temperature Sensor	J2019
15	E0237700	Gasket, Temperature Sensor	*
16	10447300	Temperature Sensor Retainer Bracket	J2948
17	F0009100	Retainer Bracket Screw	*
18	R0097600	Pressure Switch & Siphon Loop Assembly (2 PSI)	J2127
19	R0013200	Pressure Switch, 2 PSI	J2106
19	R0015500	Pressure Switch, 1-10 PSI	J2241
20	R0057800	Siphon Loop Assembly	J2127
21	R0023200	High-Limit Switch Assembly	J2021
22	R0022700	High-Limit Switch, 135° F	J2080
23	R0023000	High-Limit Switch, 150° F	J2082
24~	S0098900	High-Limit Switch Retainer Boot	*
25	10419301	High-Limit Switch Wire Harness	*
26	10418400	High-Limit Retainer Clip	*
27	10418300	High-Limit Switch Cover	*
28	R0012200	Fusible Link Assembly	J2131
29	10479900	Fusible Link Bracket	J2317
30	R0449800	Igniter Box Assembly R-Kit	*
30	R0383900	Igniter Box Assembly Kit	*
31	R0367100	Igniter	J2017
32	R0383300	Igniter Fuse Assy (set of 2)	*
33	R0334300	Flame Sense Rod	J2303
34~	R0366600	Wire Harnesses, Temp/Ignition Control	
VENT SYSTEM			
35	R0343401-05	Top Enclosure	*
36	R0343701-05	Top Filler Plate	*
37	R0318301-05	Rainshield Kit	*
38	R0316401-05	Flue Collector Assembly	*
39	10561501-05	Outdoor Vent Cap (U.S.)	J1081
39	10561511-15	Outdoor Vengt Cap (Canada only)	*

*Non-Stock Item

JANDY LITE2 LJ (MFG. 2003-PRESENT)

Key	Mfg#	Description	Item No.
VENT SYSTEM (cont'd)			
40	10561401-05	Indoor Drafthood (U.S.)	J1120
40	10561411-15	Indoor Drafthood (Canada only)	*
41	10861901-05	Flue Transition Plate	*
42	10535301-05	Adapter Plate	*
43	10211000	Clip	*
44	10726000	Flue Collector Hold Down Clamp	*
WATER SYSTEM			
45	R0056400	Inlet/Outlet Header, 2"	*
45	R0016800	Inlet/Outlet Header, Bronze, 2"	*
46	R0058300	Return Header (Includes set of 9 gaskets)	*
46	R0054600	Return Header, Bronze (Includes set of 9 gaskets)	*
47	R0057000	Header Bolt Assembly (Set of 8)	*
48	F0046100	Bolt for Headers, 2 1/2"	J2190
49	F0011100	Washer for Headers	*
50	F0003100	Nut for Headers	*
51	R0050800	Header Gasket Assembly (Set of 18)	J2120
52	R0055000	Flange & Gasket Assembly (Set of 2)	J2268
53	10573500	Flange, 2"	J2324
54	S0078000	Flange Gasket, 2"	J2322
54	S0078100	Flange Gasket, 1 1/2 - 2"	J2920
55	S0078200	Flange Sleeve, 2"	J2326
56	F0031700	Flange Bolt	J2192
57	R0316300	Rubber Grommet for Drain Plug	J6652
58~	S0116200	Grommet, Sealing, 2"	J6654
59	P0019701	Brass Connector Body	*
60	P0027000	Brass drain Plug 1/4"	J2167
61	P0027000	Brass Plug, 3/4"	*
62	R0013100	By-Pass Assembly w/o spring (Iron Cap)	J2201
62	10701401-05	By-Pass Assembly with spring (Bronze Cap)	*
63	S0079800	By-Pass Valve Rod	*
64	F0048400	Brass Nut (For Rod)	*
65	R0011500	By-Pass Valve Disc	J2183
66	10452200	By-Pass Valve Control Cap (Iron)	*
66	10557400	By-Pass Valve Control Cap (Bronze)	*
67	F0041600	Control Cap Bolts (2 Required)	*
68	S0079900	By-Pass Valve Spring, Purple	J2271
68	S0061400	By-Pass Valve Spring, White	J2161
68	S0061300	By-Pass Valve Spring, Red	J2160
68	S0061200	By-Pass Valve Spring, Blue	J2159
68	S0070100	By-Pass Valve Spring, Black	J2155
69	R0011400	By-Pass Valve Gasket	J2247
70	R0018101-05	Heat Exch. Tube Assy. (Incl. set of 18 gaskets)	J2030
71	10697401-05	Heat Exchanger Baffle (8 Required)	J2939
72	S0083900	Baffle Retainer	J2327
73	10457000	Heat Exchanger Support Clip (2 Required)	*
74~	S0000300	Flow Restrictors (2 Required)	J2157
75	R0332301-05	Heat Exchanger End Baffles (2 Required)	*
FIREBOX COMPONENTS			
76	R0383101-05	Complete Combustion Chamber Assy.	*
JACKET COMPONENTS			
77	R0343601-05	Door with Latch	*
78	R0343501-05	Jacket Assembly, Less Top Assembly	*
79	R0344300	Gap Closure, Inlet/Outlet	*

*Non-Stock Item

JANDY LX/LT Low NOx (Mfg. 2003 - Present)

Complete Product on Page 159-160

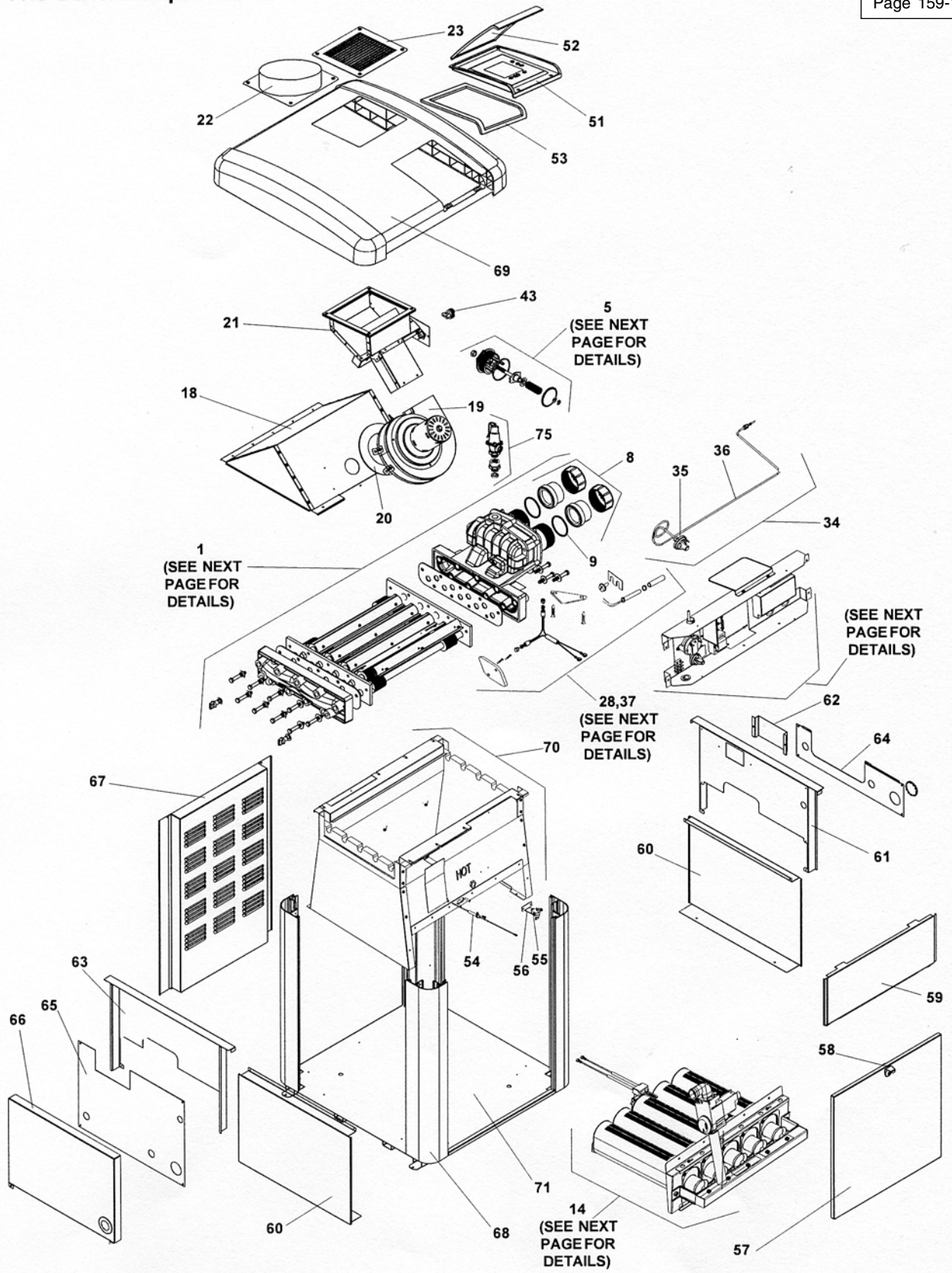

JANDY LX/LT Low NOx (Mfg. 2003 - Present) (Detail)

Complete Product on Page 159-160

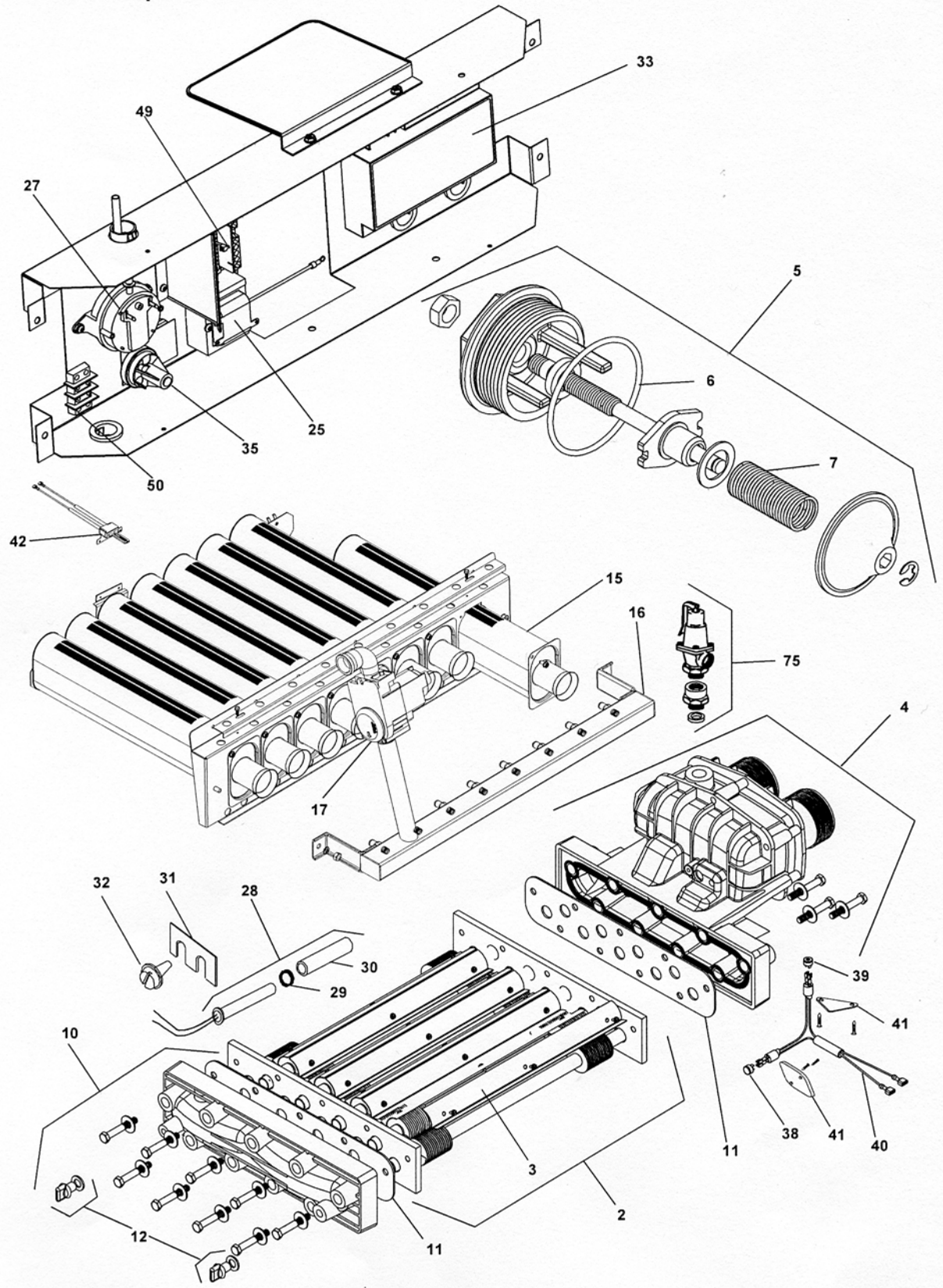

JANDY LX/LT Low NOx (Mfg. 2003 - Present)

Key	Mfg#	Description	Item No.
WATER COMPONENTS			
1	R0326303-05	Complete Heat Exchanger (Copper)	*
2	R0326603-05	Tube Assy.(Cu), with Hardware & Gaskets	J6354
3	R0334403-05	Heat Exchanger Baffles (Set of 10 including end baffles)	*
4	R0326900	Front Header, with Hardware & Gaskets	J6302
5	R0327100	By-Pass, with Hardware & Gaskets	*
6	R0336700	Gasket, Bypass Assembly	*
7	R0327200	Spring, Bypass	*
8	R0327300	Coupling Nut Kit, with Gasket, (Set of 2)	J6372
9	R0327400	Gasket, Coupling, (Set of 2)	J6374
10	R0327000	Rear Headeer, with Hardware & Gaskets	J6364
11	R0327500	Gasket, Header (front or rear)	J6376
12	R0335900	Header Drain Plug with Gasket (Set of 3)	*
13~	R0327600	Heat Exch, Hardware Kit & Gaskets	*
GAS COMPONENTS			
14	R0386203-05	Burner Tray Assembly (Nat, Low Altitude)	*
14	R0394703-05	Burner Tray Assembly (Nat, Mid Altitude)	*
14	R0394803-05	Burner Tray Assembly (Nat, High Altitude)	*
14	R0394503-05	Burner Tray Assembly (LP Low Altitude)	*
14	R0394603-05	Burner Tray Assembly (LPH Altitude)	*
15	R0386400	Burner (Ea.)	*
16~~	R0395003-05	Manifold, Gas, Nat. (Low Altitude)	*
16~~	R0394303-05	Manifold, Gas, Nat. (Mid Altitude)	*
16~~	R0394403-05	Manifold, Gas, Nat. (High Altitude)	*
16~~	R0394103-05	Manifold, Gas, LP (Low Altitude)	*
16~~	R0394203-05	Manifold, Gas, LP (High Altitude)	*
17	R0386600	Gas Valve Nat with Street Elbow	*
17	R0336900	Gas Valve LP with Street Elbow	J6410
EXHAUST SYSTEM			
18	R0386703-05	Flue Collector	*
19	R0329800	Blower Assembly	J6422
20	R0329900	Gasket with Blower Mntg Hardware	*
21	R0331500	Flue Vent Assembly	*
22	R0331403-05	Indoor Vent Collar	J6428
23	R0328500	Outdoor Grill	*
24~	R0331600	Vent Hardware Kit	*
ELECTRICAL			
25	R0061100	Transformer	J2088
26~	R0337100	Fuse Assembly, In-line	*
27	R0302000	Blower Pressure Switch	J6300
28	R0011800	Temperature Sensor with Sleeve and Gasket	J2096
29	E0116400	Gasket, Temperature Sensor	J2184
30	10444900	Plastic Sleeve, Temperature Sensor	J2251
31	10447300	Retainer Bracket, Temperature Sensor	J2948
32	F0009100	Screw, Retainer Bracket	*
33	R0386800	Ignition Control	*
34	R0334500	Pressure Switch Assembly	J6448
35	R0013200	Pressure Switch, 2 psi	J2106
36	R0334600	Siphon Loop	J6405
37	R0023200	High Limits Set	J2021
38	R0022700	High Limit 135° F	J2080
39	R0023000	High Limits 150° F	J2082
40	R0334700	Harness, High Limit Switch	J6452

*Non-Stock Item

LX/LT Low NOx (Mfg. 2003 - Present)

Key	Mfg#	Description	Item No.
ELECTRICAL (cont'd)			
41	R0336500	Retainer Plates, High Limits (Set of 2)	*
42	R0386900	Hot Surface Ignitor	*
43	R0329400	Exhaust Temperature, Limit Switch	J6458
44~	R0397600	Wire Harness Ser Complete	*
45~	R0330900	Wire Harness, Power Transformer	*
46~	R0369500	Wire Harness with PCB	J6438
46~	R0331000	Wire Harness, Ignition Control	*
47~	R0331100	Wire Harness, Gas Valve	*
48~	R0331200	Wire Harness, Safety Loop	*
49	R0397500	Power Distribution Circuit Board	*
50	R0097800	Terminal Block for Fireman's Switch	*
51	R0329600	Temperature Control with Bezel, Gasket & Cover - LX Only	J6476
52~	R0350500	Temperature Control with Bezel, Gasket & Cover - LT Only	*
52	R0330600	Cover, Temperature Control	J6518
53	R0387600	Gasket, Temperature Control/Top	*
54	R0387000	Flame Sense Rod	J2087
55	R0012200	Fusible Link	J2131
56	R0337200	Bracket, Fusible Link	*
JACKET ASSEMBLY			
57	R0387103-05	Door with Latch	*
58	R0334900	Door Latch Assembly with Handle	*
59	R0335103-05	Cover Panel, Raceway	*
60	R0330100	Panel, Side, Lower (fits left or right)	*
61	R0330200	Panel, Right Side, Upper	*
62	R0336600	Cover Panel, Exhaust Switch	*
63	R0335200	Panel, Left Side, Upper	*
64	R0335300	Cover Plate, I/O Header Side	*
65	R0335400	Cover Plate, Return Header Side	*
66	R0335500	Cover Panel, Left Side	*
67	R0330303-05	Rear Panel	*
68	R0330400	Corner Posts	*
69	R0330503-05	Top Assembly	*
70	R0387203-05	Combustion Chamber Assembly	*
71	R0335608-10	Base Panel	*
OPTIONAL			
72~	R0330803-05	Non Comb. Base	*
73~	R0335800	Touch-up Paint	*
74~	R0336000	Temperature Rise Measurement Kit	J2286
75	R0336100	Pressure Relief Valve	J6540
76~	R0382800	High Temperature Silicone Sealant	*

*Non-Stock Item

Notes:

- When ordering a kit for a model 250 specify as R#####-03, When ordering a kit for a model 400 specify as R#####-05
- All hardware sets contain all pieces necessary for assembly, including gaskets. Not shown.
- Gaskets and hardware are included in all kits that involve the removal of a gasket as part of the procedure to replace a part.
~Parts not shown on key view
~~Manifold kit includes installed orifices but does not include gas valve

MasterTemp - Water System

Complete Product on Page 165

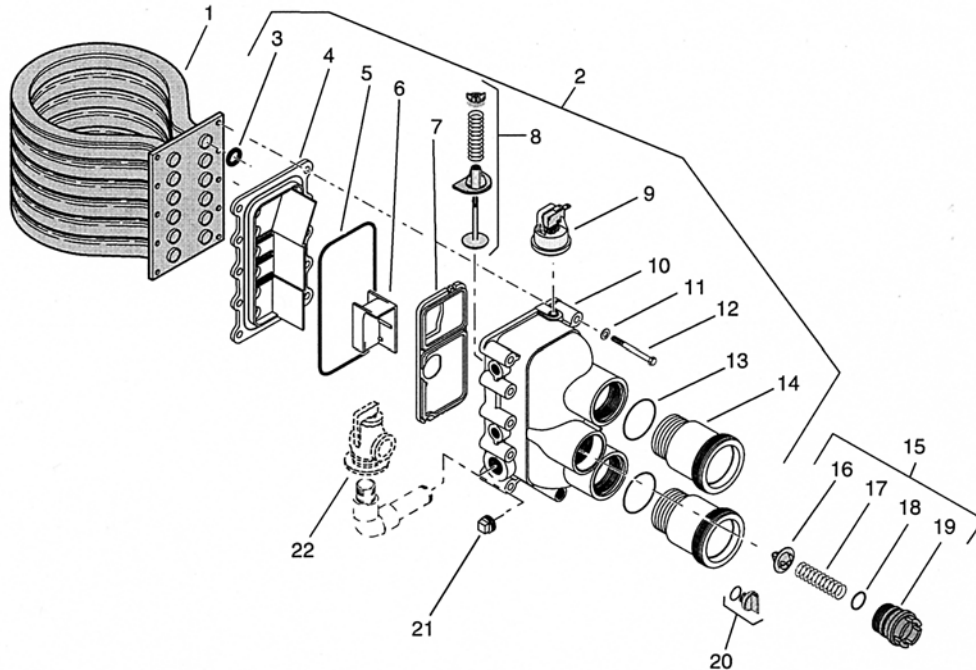

Key	Pentair No.	Description	Item No.
1,3	77707-0232	Tube Sheet Coil Assembly Kit (NA,LP Series) For 175/200 NA/LP	*
1,3	460747	Tube Sheet Coil Assembly Kit (NA,LP Series) For 250 NA/LP	*
1,3	77707-0233	Tube Sheet Coil Assembly Kit (NA,LP Series) For 300 NA/LP	J7258
1,3	77707-0234	Tube Sheet Coil Assembly Kit (NA,LP Series) For 400 NA/LP	*
1,3	473710	Tube Sheet Coil Assembly Kit (NA,HD Series) For 250 NA/LP	*
1,3	77707-0244	Tube Sheet Coil Assembly Kit (NA,HD Series) For 400 NA/LP	*
2	77707-0014	Manifold Kit (Includes Keys 3-14, 21 and Keys 5-7 in Electrical Systems) For 175/200 NA/LP	J7101
2	460748	Manifold Kit (Includes Keys 3-14, 21 and Keys 5-7 in Electrical Systems) For 250 NA/LP	J7102
2	77707-0015	Manifold Kit (Includes Keys 3-14, 21 and Keys 5-7 in Electrical Systems) For 300 NA/LP	J7103
2	77707-0016	Manifold Kit (Includes Keys 3-14, 21 and Keys 5-7 in Electrical Systems) For 400 NA/LP	J7104
3	77707-0117(6)	Coil/Tubesheet Sealing O-Ring Kit For 175/200 NA/LP	J7105
3	460749(8)	Coil/Tubesheet Sealing O-Ring Kit For 250 NA/LP	J7106
3	77707-0118(10)	Coil/Tubesheet Sealing O-Ring Kit For 300 NA/LP	J7264
3	77707-0119(12)	Coil/Tubesheet Sealing O-Ring Kit For 400 NA/LP	J7107
4		Manifold Bottom Plate	Part of Kit
5		Manifold O-Ring	Part of Kit
*	77707-0120	O-Ring Kit (Includes Keys 3-5. For all Models)	*
6		Manifold Insert	Part of Kit
7		Manifold Baffle Plate	Part of Kit
8		Manifold Bypass Valve	Part of Kit
9	42001-0060S	Water Pressure Switch For All Models	J7268
10		Manifold	Part of Kit
11		5/16 Washer, S.S.(10)	Part of Kit

*Non-Stock Item

Key	Pentair No.	Description	Item No.
12		5/16 x 18 x 2-3/4 Hex Cap Screws (10)	Part of Kit
13		Connector Tube O-Ring (2)	Part of Kit
14	77707-0017	Connector Tube Kit (Incl. 1 Connector Tube and 1 Connector Tube O-Ring)	J7269
15	77707-0010	Thermal Regulator Kit (Includes Keys 16-19 and Spring Clip)	J7292
16	38000-0007S	Thermal Regulator (Includes Spring Clip)	J7294
17		Thermal Regulator Spring	Part of Kit
18	35505-1313	Thermal Regulator Cap O-Ring	N5088
*		Thermal Regulator Spring Clip	Part of Kit
19		Thermal Regulator Cap	Part of Kit
20	U178-920P	Drain Plug	K3439
21	U78-60ZPS	3/4" Pipe Plug	*
22	38674-0719	Pressure Relief Valve	J7298

**Non Stock Item*

MasterTemp - Electrical System

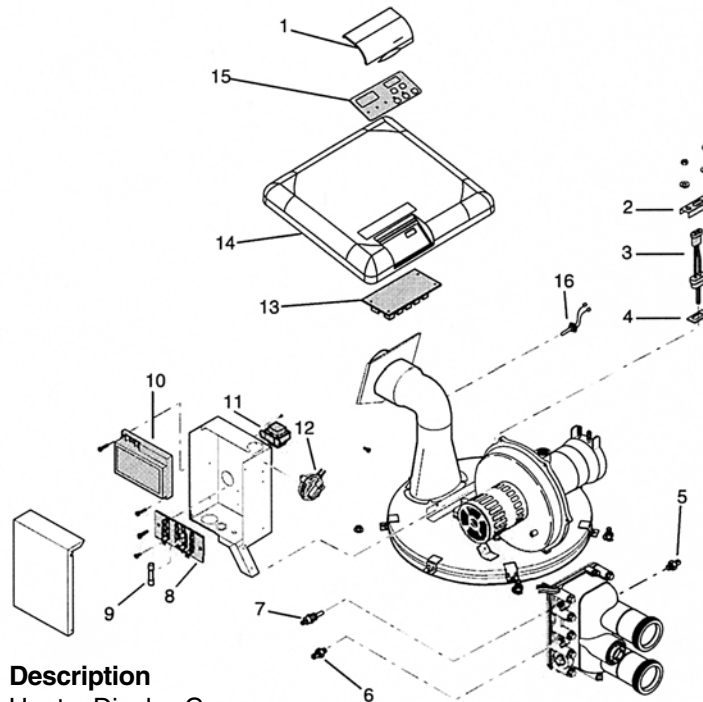

Key	Pentair No.	Description	Item No.
1	42002-0035	Heater Display Cover	*
2	42001-0030	Igniter Bracket	J7112
3	77707-0054	Igniter/Igniter Gasket Kit Incl. Keys 3 and 4	J7110
4	42001-0066S	Igniter Gasket	J7108
5	42002-0025S	Automatic Gas Shutoff Switch (AGS)	J7109
6	42001-0063S	High Limit Switch	J7114
7	42001-0053S	Thermistor	J7120
8	42001-0056S	Terminal Board	J7111
9	32850-0099	Fireman's Switch Fuse (1.25A, 1-1/4")	J7113
10	42001-0052S	Ignition Control Module	J7128
11	42001-0107S	Transformer, 120/240V	J7116
12	42001-0061S	Air Flow Switch	J7115
13	42002-0007S	Control Board Kit (NA and LP Series)	J7117
*	42001-0104S	Heater Wiring Harness	J7119
*	42001-0105S	120/240 Volt Plug Kit	J7121
14	42002-0034Z	Heater, Top	*
15	472610Z	Membrane pad (NA and LP Series)	J7118
16	42002-0024S	Stack Flue Sensor	J7141

**Non Stock Item*

PENTAIR (PUREX, PAC-FAB) MINIMAX PLUS HEATER

Models

- 150
- 200
- 250
- 300
- 350
- 400

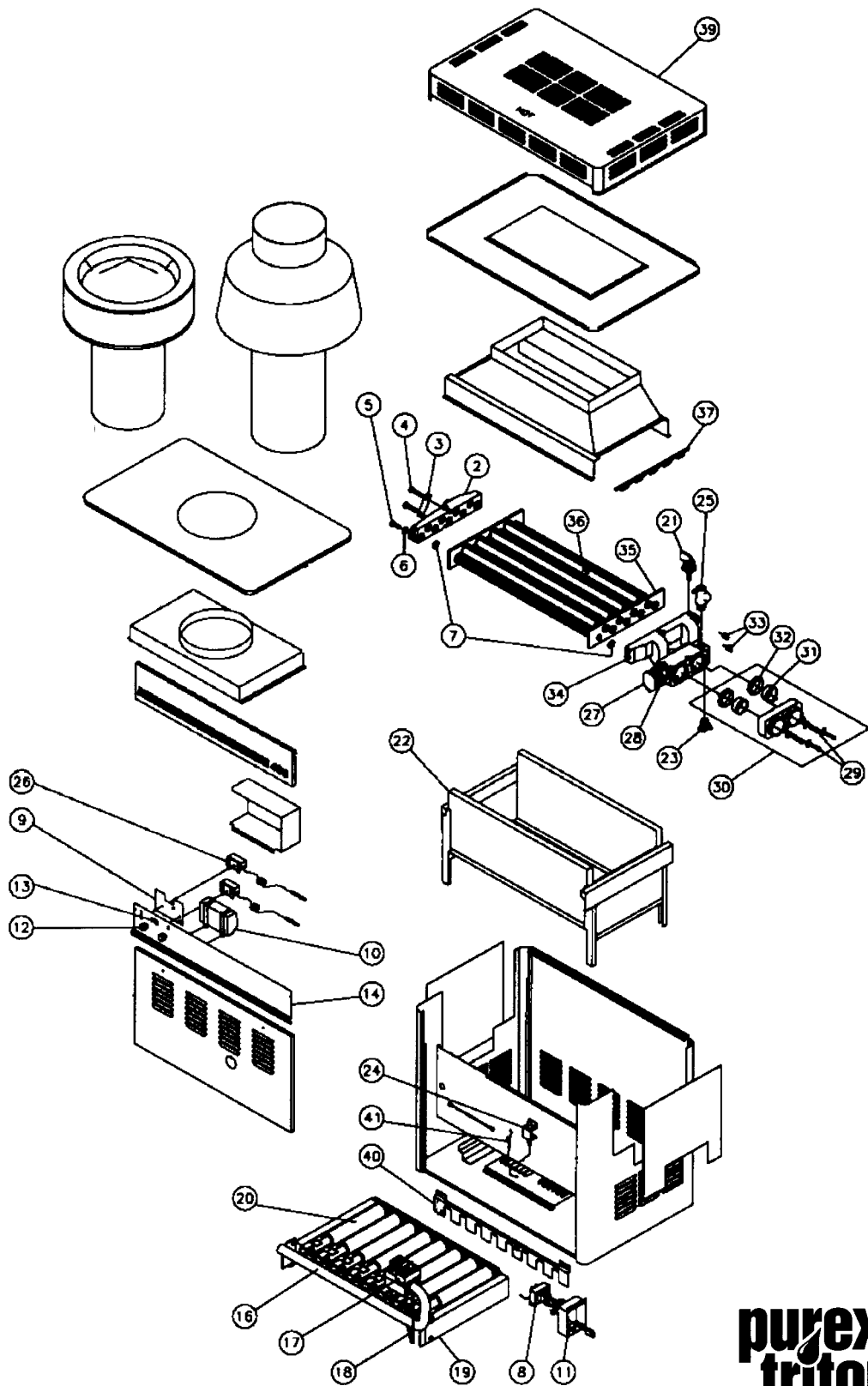

PENTAIR (PUREX, PAC-FAB) MINIMAX PLUS HEATER Models 150 Thru 400

KEY	MFG NO.	DESCRIPTION	ITEM NO.
2	070994	Return Header	K9574
3	074216	Bracket Washer (2 needed)	J4464
4	073739	Bolt 3/8" x 2 (4 needed)	K9575
5	070416	Bolt 3/8" 16 x 1-1/2" (4 needed)	J4450
6	072180	Washer 3/8" ID, 1" OD (4 needed)	K9577
7	070951	Tube Seal Gasket (18 needed)	K9578
8	471360	Transformer w/ Circuit Breaker - Dual Voltage (Replaces #07-4033)	J4313
9	470179	Thermostat Circuit Board - IID	J4466
10	073584	Ignition Module Natural Gas	K9593
10	073585	Ignition Module Propane Gas	K9594
11	470122	Junction Box	J4468
12	470184	Thermostat Knob (2 needed)	J4470*
13	470186	Switch Rocker (Double Pole & Throw)	J4472
14	470295	Control Panel Assy, Complete - Natural IID (150)	J4474
14	470296	Control Panel Assy, Complete - Natural IID (200)	OBS
14	470297	Control Panel Assy, Complete - Natural IID (250)	J4478
14	470298	Control Panel Assy, Complete - Natural IID (300)	OBS
14	470299	Control Panel Assy, Complete - Natural IID (350)	J4482
14	470187	Control Panel Assy, Complete - Natural IID (400)	J4484*
14	470987	Control Panel Assy, Complete - Propane IID (150)	J4486*
14	470988	Control Panel Assy, Complete - Propane IID (200)	OBS
14	470989	Control Panel Assy, Complete - Propane IID (250)	J4490*
14	470990	Control Panel Assy, Complete - Propane IID (300)	OBS
14	470991	Control Panel Assy, Complete - Propane IID (350)	OBS
14	470992	Control Panel Assy, Complete - Propane IID (400)	J4496*
14	471020	Control Panel Assy, Complete - Millivolt (150)	J4498*
14	471021	Control Panel Assy, Complete - Millivolt (200)	J4331*
14	471022	Control Panel Assy, Complete - Millivolt (250)	OBS
14	471023	Control Panel Assy, Complete - Millivolt (300)	J4335*
14	471024	Control Panel Assy, Complete - Millivolt (350)	J4337*
14	471025	Control Panel Assy, Complete - Millivolt (400)	J4339*
16	070256	Manifold Burner (150)	K9553*
16	075525	Manifold Burner (200)	OBS
16	070257	Manifold Burner (250)	K9554*
16	075526	Manifold Burner (300)	J4344*
16	075527	Manifold Burner (350)	J4346*
16	070258	Manifold Burner (400)	K9555*
17	073998	Gas Valve, Natural - IID	K9611
17	073999	Gas Valve, Propane - IID	K9612
17	075457	Gas Valve, Natural - MV	J4348
17	075458	Gas Valve, Propane - MV	J4350
18	075191	Pilot Tube - IID (150 / 200)	K9558*
18	075192	Pilot Tube - IID (250 / 300)	K9619
18	075193	Pilot Tube - IID (350 / 400)	K9620
18	075471	Pilot Tube - MV (150 / 200)	OBS
18	076085	Pilot Tube - MV (250 / 300)	J4366*
18	076086	Pilot Tube - MV (350 / 400)	J4368*

*Non-Stock Item

PENTAIR (PUREX / PAC-FAB) MINIMAX PLUS HEATER**Models 150 Thru 400**

KEY	MFG NO.	DESCRIPTION	ITEM NO.
19	073752	Burner Tray Assy., Complete - Natural IID (150)	K9559*
19	075499	Burner Tray Assy., Complete - Natural IID (200)	J4370*
19	073751	Burner Tray Assy., Complete - Natural IID (250)	K9560*
19	075500	Burner Tray Assy., Complete - Natural IID (300)	J4372*
19	075501	Burner Tray Assy., Complete - Natural IID (350)	J4374*
19	073750	Burner Tray Assy., Complete - Natural IID (400)	K9561*
19	073906	Burner Tray Assy., Complete - Propane IID (150)	K9562*
19	075508	Burner Tray Assy., Complete - Propane IID (200)	J4376*
19	073905	Burner Tray Assy., Complete - Propane IID (250)	K9563*
19	075509	Burner Tray Assy., Complete - Propane IID (300)	OBS
19	075510	Burner Tray Assy., Complete - Propane IID (350)	J4380*
19	073904	Burner Tray Assy., Complete - Propane IID (400)	K9564*
19	075493	Burner Tray Assy., Complete - Natural MV (150)	J4382*
19	075496	Burner Tray Assy., Complete - Natural MV (200)	OBS
19	075494	Burner Tray Assy., Complete - Natural MV (250)	J4386*
19	075497	Burner Tray Assy., Complete - Natural MV (300)	J4388*
19	075498	Burner Tray Assy., Complete - Natural MV (350)	OBS
19	075495	Burner Tray Assy., Complete - Natural MV (400)	J4392*
19	075502	Burner Tray Assy., Complete - Propane MV (150)	J4394*
19	075505	Burner Tray Assy., Complete - Propane MV (200)	J4396*
19	075503	Burner Tray Assy., Complete - Propane MV (250)	J4398*
19	075506	Burner Tray Assy., Complete - Propane MV (300)	J4406*
19	075507	Burner Tray Assy., Complete - Propane MV (350)	J4408*
19	075504	Burner Tray Assy., Complete - Propane MV (400)	J4412*
20	070230	Burner, 150 (2 needed)	K9565
20	070230	Burner, 200 (3 needed)	K9565
20	070230	Burner, 250 (4 needed)	K9565
20	070230	Burner, 300 (5 needed)	K9565
20	070230	Burner, 350 (6 needed)	K9565
20	070230	Burner, 400 (7 needed)	K9565
20A	470550	Burner w/ Pilot Bracket	J4343
21	470190	Pressure Switch	J4345
22	073858	Combustion Chamber Assy., Complete (150)	K9550*
22	075586	Combustion Chamber Assy., Complete (200)	J4336*
22	073857	Combustion Chamber Assy., Complete (250)	K9551*
22	075587	Combustion Chamber Assy., Complete (300)	J4338*
22	075588	Combustion Chamber Assy., Complete (350)	J4340*
22	073856	Combustion Chamber Assy., Complete (400)	K9552*
23	072134	Drain Valve, 3/4"	J4304*
24	075459	Presslite Ignitor Assy.	J4444
25	-----	Valve Relief 3/4", 75 PSI	J2128
26	072022	Thermostat Millivolt	J4446
27	471424	Flow Valve Assy., Complete (Replaces 073841)	K9579
28	074015	Flow Valve Gasket (4 needed)	J4302
29	075492	Bolt 3/8" - 16 x 2-1/2 (2 needed)	K9581
30	075284	Quick Flange Kit	J4452
31	071895	Sleeve In/Out 2" (2 needed)	K9583
32	070544	Bushing In/Out 2" Rubber (2 needed)	K9584
32	070299	Bushing 2" to 1-1/2" Rubber (2 needed)	OBS
33	071017	Safety Shut Off (2 needed)	J4349*

*Non-Stock Item

PENTAIR (PUREX / PAC-FAB) MINIMAX PLUS HEATER Models 150 Thru 400

KEY	MFG NO.	DESCRIPTION	ITEM NO.
34	070985	Main Header (In/Out)	K9587
35	074452	Heat Exchanger Without Heads (150)	K9588
35	075628	Heat Exchanger Without Heads (200)	J4456*
35	074451	Heat Exchanger Without Heads (250)	K9589
35	075629	Heat Exchanger Without Heads (300)	J4458*
35	075630	Heat Exchanger Without Heads (350)	J4460
35	074074	Heat Exchanger Without Heads (400)	K9590
36	070277	Baffle (150) (8 needed)	J4351*
36	075559	Baffle (200) (8 needed)	J4353*
36	070276	Baffle (250) (8 needed)	J4355*
36	075560	Baffle (300) (8 needed)	J4357*
36	075561	Baffle (350) (16 needed)	OBS
36	070278	Baffle (400) (16 needed)	J4361*
37	073810	Baffle, Hold Down (2 Baffles for 400 Model)	OBS
39	470471	Outdoor Top Assy. (150)	J4363*
39	470472	Outdoor Top Assy. (200)	J4367*
39	470473	Outdoor Top Assy. (250)	J4369*
39	470474	Outdoor Top Assy. (300)	J4371*
39	470475	Outdoor Top Assy. (350)	J4373*
39	470476	Outdoor Top Assy. (400)	J4375*
40	075783	Lightback Shield (150) (2 needed)	OBS
40	075784	Lightback Shield (200) (2 needed)	OBS
40	075785	Lightback Shield (250) (2 needed)	OBS
40	075786	Lightback Shield (300) (2 needed)	OBS
40	075787	Lightback Shield (350) (2 needed)	J4385*
40	075788	Lightback Shield (400) (2 needed)	J4387*
41	075461	Ignitor, Electrode, Millivolt	J4448
--	470965	Wire Kit, Harness (Gas Valve) IID	J4389
--	073732	Wire Kit, Harness (Control Box) IID (150, 250, 300, 350, 400)	OBS
--	470414	Therm Knob Stopper (2 needed)	J4391*
--	470178	Power Element (Flow Valve)	J4393*
--	471204	Pilot, Natural, IID w/High Tension Wire (Replaces 07-1511)	K9568
--	471205	Pilot, Propane, IID w/High Tension Wire (Replaces 07-1510)	K9569
--	471292	Pilot, Natural, Millivolt	J4395
--	471291	Pilot, Propane, Millivolt	J4397*
--	071515	Pilot, Generator	J4422
--	075173	Thermal Cut Off	K9603
--	470180	Thermostat, Probe, Complete	J4399
--	074202	Indicator Board LED Lightstrip	J4320
--	070273	Potentiometer (TSTAT) IID (2 needed)	J4322
--	073727	Orifice Main Burner, Natural	K9570**
--	073728	Orifice Main Burner, Propane	K9571**

***Non-Stock Item**

** (150 - 3 needed, 200 - 4 needed, 250 - 5 needed, 300 - 6 needed, 350 - 7 needed, 400 - 8 needed)

Complete Product on Page 165

MiniMax NT STD Heater - (Non-ASME Shown)

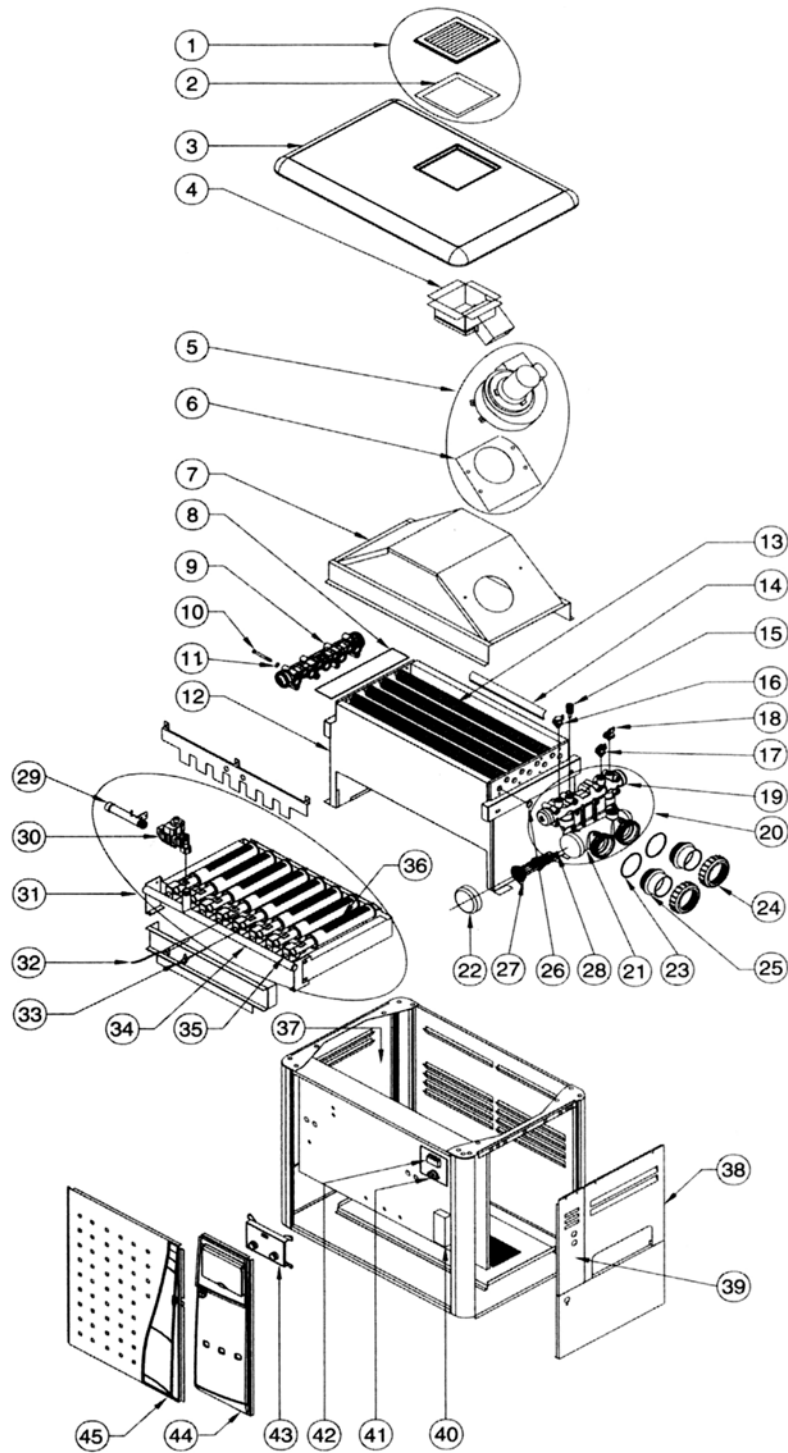

(Note: Pictorial is shown with 6800 Controller)

PENTAIR MiniMax NT STD Heater

Key	Mfg.#	Description	Item No.
1	472352	Exhaust Grill w/gasket	*
2	471701	Gasket, Exhaust Grill	*
3	472353	Top Cover w/posts - 200	*
	472354	Top Cover w/posts - 250	*
	472355	Top Cover w/posts - 300	*
	472356	Top Cover w/posts - 400	*
4	472373	Exhaust Assembly - 200, 300, 400	*
	472376	Exhaust Assembly - 250	*
5	472361	Blower w/gasket - 200	*
	472362	Blower w/gasket - 250, 300	J4530
	472374	Blower w/gasket - 400	*
6	471610	Blower gasket	*
7	472008	Flue Collector - 200	OBS
	472007	Flue Collector - 250	*
	472006	Flue Collector - 300	*
	472005	Flue Collector - 400	*
8	472270	Isulation, Header/Hi-limit	*
9	471991	Return Header Assembly	J4532
10	471622	Bolt, Heat Exchanger (need 16)	J4523
11	072184	Washer, Heat Exchanger (need 16)	K3828
12	471904	Fire Box Assembly - 200	OBS
	471835	Fire Box Assembly - 250	*
	471922	Fire Box Assembly - 300	*
	471332	Fire Box Assembly - 400	*
13	471910	Heat Exchanger w/Header - 200	*
	471785	Heat Exchanger w/Header - 250	*
	471928	Heat Exchanger w/Header - 300	*
	471838	Heat Exchanger w/Header - 400	*
13	471933	Heat Exchanger w/o Header - 200	*
	471934	Heat Exchanger w/o Header - 250	*
	471935	Heat Exchanger w/o Header - 300	*
	471936	Heat Exchanger w/o Header - 400	*
13	470371	Heat Exchanger w/Header ASME - 200	*
	470372	Heat Exchanger w/Header ASME - 250	*
	470373	Heat Exchanger w/Header ASME - 300	*
	470375	Heat Exchanger w/Header ASME - 400	*
14	471642	Baffle - 200 (need 8)	*
	471641	Baffle - 250 (need 8)	*
	471896	Baffle - 300 (need 8)	*
	471640	Baffle - 400 (need 8)	J4539
15	471566	Thermistor Probe	J4521
16	471587	Hi-Limit Thermostat 115°F	*
17	471694	Hi-Limit Thermostat 150°F	J4310
18	470190	Water Pressure Switch - ASME	J4345
	472125	Water Pressure Switch NON-ASME	*

*Non-Stock Item

PENTAIR MiniMax NT STD Heater

Key	Mfg#	Description	Item No.
19	472363	In/Out Top Sub-Header Assembly	J4543
20	471992	In/Out Main Header Assembly	J4531
21	472364	In/Out Bottom Sub-Header	J4544
22	471420	Cap, In/Out Bottom Sub-Header	*
23	274494	O-Ring, Adapter	H3371
24	274440	Adapter, Bulkhead Ring	J4526
25	471441	Adapter, Bulkhead, 2"	J4528
26	070951	Gasket, Fin Tube, Seal	K9578
27	471750	Flow Valve Assembly	J4535
28	472330	Power Element, Flow Valve	*
29	472365	Sub-Gas Manifold w/ plug	*
30	471601	Gas Valve - Natural Gas	OBS
	471671	Gas Valve - Propane	OBS
31	472042	Burner Tray Assembly - 200 Natural	OBS
	472037	Burner Tray Assembly - 250 Natural	OBS
	472033	Burner Tray Assembly - 300 Natural	OBS
	472028	Burner Tray Assembly - 400 Natural	OBS
31	471907	Burner Tray Assembly - 200 Propane	OBS
	471913	Burner Tray Assembly - 250 Propane	OBS
	471925	Burner Tray Assembly - 300 Propane	OBS
	471931	Burner Tray Assembly - 400 Propane	OBS
32	471602	Igniter	K9602
33	471603	Flame Sensor	J4542
34	472023	Gas Manifold w/ Orifices 200 - Natural	OBS
	472022	Gas Manifold w/ Orifices 250 - Natural	OBS
	472021	Gas Manifold w/ Orifices 300 - Natural	OBS
	472020	Gas Manifold w/ Orifices 400 - Natural	OBS
34	472027	Gas Manifold w/ Orifices 200 - Propane	OBS
	472026	Gas Manifold w/ Orifices 250 - Propane	OBS
	472025	Gas Manifold w/ Orifices 300 - Propane	OBS
	472024	Gas Manifold w/ Orifices 400 - Propane	OBS
35	073727	Orifices, Natural	K9570
	073728	Orifices, Propane	K9571
36	070230	Burner	K9565
37	471970	Burner w/ Bracket	OBS
40	472015	Junction Box Assembly	OBS
41	472178	Air Pressure Switch - 200	OBS
	472180	Air Pressure Switch - 250	OBS
	472181	Air Pressure Switch - 300	OBS
	472183	Air Pressure Switch - 400	OBS
42	472080	Module, Ignition Control	OBS
43	472086	Temperature Controller Assembly	J4468
	075173	Thermal Cut-off (not shown)	K9603
	471571	Transformer, 40 VA (not shown)	OBS
	472375	Wire Harness Assembly (not shown)	OBS

*Non-Stock Item

RAYPAK RP 2100 HEATERS Models C-R185 to C-R405 Metal Headers

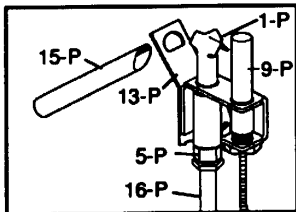
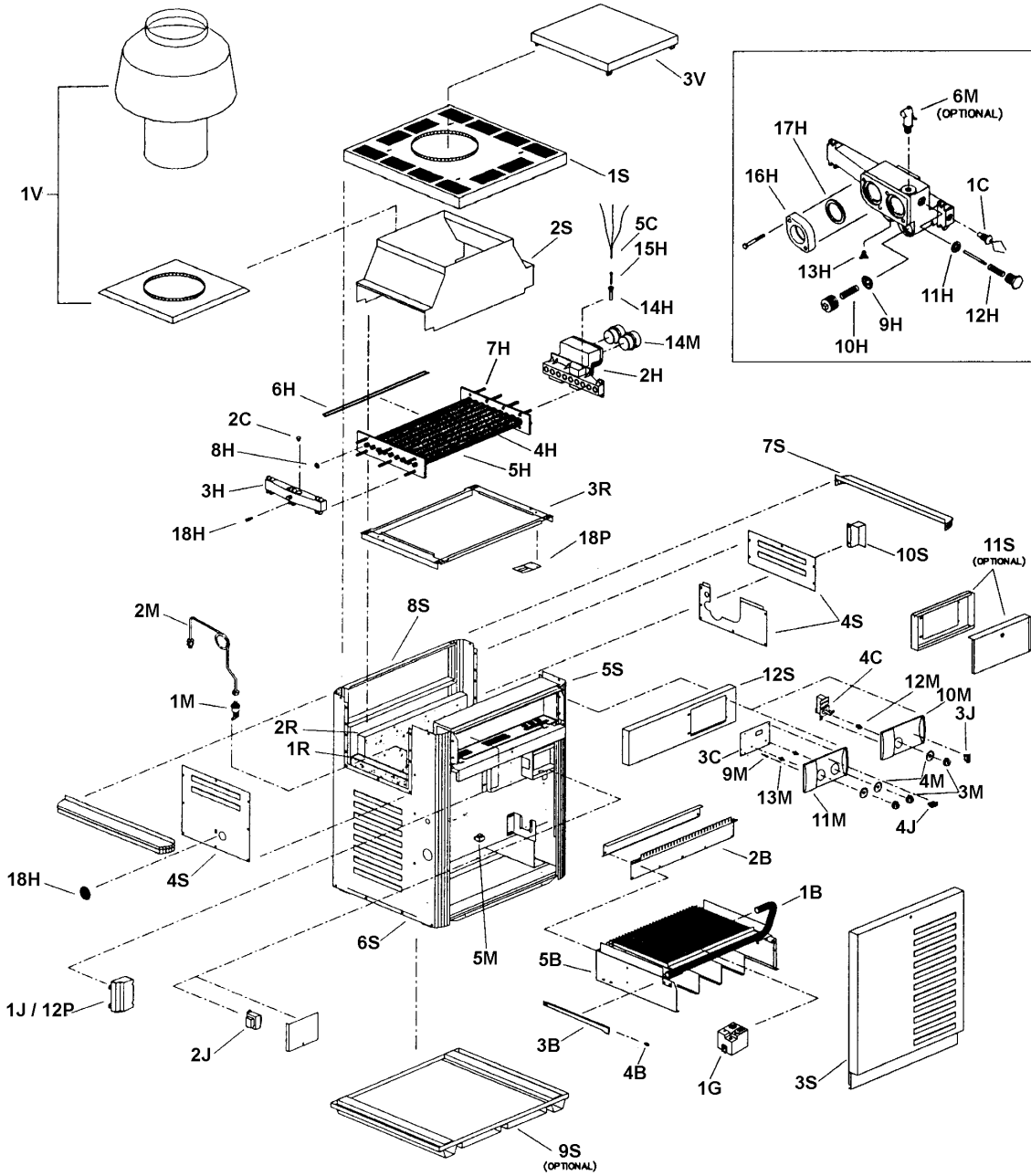

Robertsshaw MV

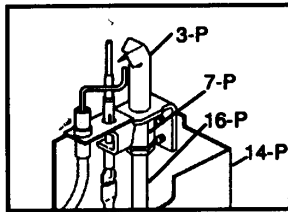

Robertsshaw IID

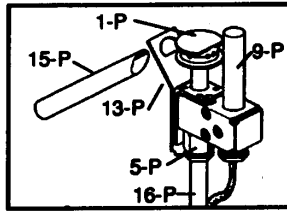

Honeywell MV

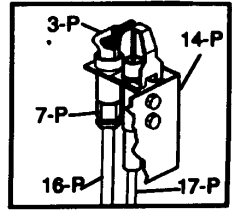

Honeywell IID

RAYPAK RP 2100 HEATERS
Models C-R185 to C-R405 Metal Headers

KEY	MFG NO.	DESCRIPTION	ITEM NO.
1B	005213F	Burner Tray with Burners (185)	J1901*
1B	005214F	Burner Tray with Burners (265)	J1902*
1B	005215F	Burner Tray with Burners (335)	J1903
1B	005216F	Burner Tray with Burners (405)	J1904*
1B	005217F	Burner Tray without Burners (185)	J1905*
1B	005218F	Burner Tray without Burners (265)	J1906*
1B	005219F	Burner Tray without Burners (335)	J1907*
1B	005220F	Burner Tray without Burners (405)	J1908*
1B	005221F	Burner Tray with Gas Valve - Natural, MV (185)	J1909*
1B	005222F	Burner Tray with Gas Valve - Natural, MV (265)	J1921*
1B	005223F	Burner Tray with Gas Valve - Natural, MV (335)	J1922
1B	005224F	Burner Tray with Gas Valve - Natural, MV (405)	J1923
1B	005225F	Burner Tray with Gas Valve - Propane, MV (185)	J1924*
1B	005226F	Burner Tray with Gas Valve - Propane, MV (265)	J1925
1B	005227F	Burner Tray with Gas Valve - Propane, MV (335)	J1926*
1B	005228F	Burner Tray with Gas Valve - Propane, MV (405)	J1927*
1B	005229F	Burner Tray with Gas Valve - Natural, Electronic (185)	J1928*
1B	005230F	Burner Tray with Gas Valve - Natural, Electronic (265)	J1929
1B	005231F	Burner Tray with Gas Valve - Natural, Electronic (335)	J1931*
1B	005232F	Burner Tray with Gas Valve - Natural, Electronic (405)	J1932
1B	005233F	Burner Tray with Gas Valve - Propane, Electronic (185)	J1933*
1B	005234F	Burner Tray with Gas Valve - Propane, Electronic (265)	J1934*
1B	005235F	Burner Tray with Gas Valve - Propane, Electronic (335)	J1935*
1B	005236F	Burner Tray with Gas Valve - Propane, Electronic (405)	J1936*
2B	005237F	Burner Spacer/Hold Down Kit (185)	J1937*
2B	005238F	Burner Spacer/Hold Down Kit (265)	J1938*
2B	005239F	Burner Spacer/Hold Down Kit (335)	J1939*
2B	005240F	Burner Spacer/Hold Down Kit (405)	J1940*
3B	301210	Burner (185 / 13, 265 / 19, 335 / 24 & 405 / 29)	J1529
4B	350080	Burner Orifice - Natural Gas	J1530
4B	350083	Burner Orifice - Propane Gas	J1531
5B	005265F	Burner Tray without Manifold & without Burners (185)	J1941*
5B	005266F	Burner Tray without Manifold & without Burners (265)	J1942*
5B	005267F	Burner Tray without Manifold & without Burners (335)	J1943*
5B	005268F	Burner Tray without Manifold & without Burners (405)	J5248
1C	600892B	AGS 135 degrees (Auto Gas Shutoff)	J1545
2C	600893B	High Limit 140 degrees	J1546
3C	005241F	P.C. Control Board, Electronic IID Units	J1945
4C	600827B	Thermostat Control, Millivolt Units	J1555
5C	005299B	Temperature Sensor, Electronic IID Units	J1946
1G	003898F	Combination Gas Valve - Natural, Millivolt	J1538
1G	003899F	Combination Gas Valve - Propane, Millivolt	J1539
1G	003900F	Combination Gas Valve - Natural, Electronic IID	J1569
1G	004306F	Combination Gas Valve - Propane, Electronic IID	J1570
1H	005244F	Heat Exchanger Assy. - Complete (185) w/Cast Iron Headers	J1950
1H	005245F	Heat Exchanger Assy. - Complete (265) w/Cast Iron Headers	J1951*
1H	005246F	Heat Exchanger Assy. - Complete (335) w/Cast Iron Headers	J1953*
1H	005247F	Heat Exchanger Assy. - Complete (405) w/Cast Iron Headers	J1954*
1H	005248F	Heat Exchanger Assy. - Complete (185) w/Bronze Headers	J1955*
1H	005249F	Heat Exchanger Assy. - Complete (265) w/Bronze Headers	J1956*
1H	005250F	Heat Exchanger Assy. - Complete (335) w/Bronze Headers	J1957*
1H	005251F	Heat Exchanger Assy. - Complete (405) w/Bronze Headers	J1958*

*Non-Stock Item

RAYPAK RP 2100 HEATERS

Models C-R185 to C-R405 Metal Headers

KEY	MFG NO.	DESCRIPTION	ITEM NO.
2H	003759F	Inlet & Outlet Header - Cast Iron	J1639
2H	003760F	Inlet & Outlet Header - Bronze	J1661
3H	002450F	Return Header - Cast Iron	J1659
3H	002451F	Return Header - Bronze	J1662
4H	005252F	Heat Exchanger Tube Bundle Assembly (185)	J1679
4H	005253F	Heat Exchanger Tube Bundle Assembly (265)	J1680
4H	005254F	Heat Exchanger Tube Bundle Assembly (335)	J1681
4H	005255F	Heat Exchanger Tube Bundle Assembly (405)	J1682
6H	005260F	Baffle Kit for (185) - Qty 8	J1683*
6H	005261F	Baffle Kit for (265) - Qty 8	J1684*
6H	005262F	Baffle Kit for (335) - Qty 8	J1685*
6H	005263F	Baffle Kit for (405) - Qty 8	J1686*
7H	001303F	Header Bolt Kit	J1632
8H	800014B	Header Gasket(Pkg of 9)	J1670
9H	062234B	Unitherm Governor	J1671
10H	850254	Retainer Spring, Uniterm Governor	J1635
11H	062235B	Bypass Valve	J1636
12H	850252	Bypass Spring	J1637
13H	500719	Drain Valve	J1584
14H	003765F	Sensor Well	J1645
15H	300203	Retaining Clip for Sensor Well	J1577*
16H	003766F	Inlet & Outlet Flange	J1640
17H	062236B	Flange Gasket , 1-1/2" Connections	J1675
17H	800080B	Flange Gasket , 2" Connections	J1641
18H	005264F	Rear Drain Plug & Cover	J1688
1J	004817B	Ignition Control, Electronic IID - Natural Gas	J1585
1J	004818B	Ignition Control, Electronic IID - Propane Gas	J1587
2J	006736F	Transformer, 120/240/24 Volt (Old #005345F/#650531)	J5214
3J	650902	Rocker Switch, Millivolt Units	J1689
4J	650903	Rocker Switch, Electronic IID Units	J1690
1M	062237B	Pressure Switch	J1535
2M	003272F	Pressure Switch Tube Assembly	J1678
3M	800303	Thermostat Knob (1)	J1691
4M	305138	Knobstop (1)	J1579
5M	005899F	Fusible Link (Old # 650914)	J1692
6M	500648	Pressure Relief Valve, PRV-125 (Optional)	J1602
8M	005269F	Wire Harness, Millivolt Unit	J1693
8M	005270F	Wire Harness, Electronic IID Unit	J1694
9M	005271F	LED's (2 Green & 2 Red)	J1695*
10M	005291F	Control Panel, Millivolt Unit	J1696
11M	005292F	Control Panel, Electronic IID Unit	J1697
12M	800307	Thermostat Shaft, Millivolt Unit	J1698
13M	800304	Thermostat Shaft, Electronic IID Unit	J1699
1P	600525B	Pilot, Natural, Millivolt Unit	J1536
1P	600575B	Pilot, Propane, Millivolt Unit	J1537
3P	002003F	Pilot, Natural, Electronic IID Unit (Natural & Propane)	J1590
5P	003901F	Pilot Orifice, Natural, Millivolt Unit	J1628
5P	003902F	Pilot Orifice, Propane, Millivolt Unit	J1571
7P	003903F	Pilot Orifice, Natural, Electronic IID Unit	J1572
7P	004308F	Pilot Orifice, Propane, Electronic IID Unit	J1576
9P	600019B	Pilot Generator, Millivolt	J1534

*Non-Stock Item

RAYPAK RP 2100 HEATERS
Models C-R185 to C-R405 Metal Headers

KEY	MFG NO.	DESCRIPTION	ITEM NO.
12P	004817B	Ignition Control, Electronic IID, Natural	J1585
12P	004818B	Ignition Control, Electronic IID, Propane	J1587
13P	306693	Pilot Mounting Bracket, Millivolt Unit	J1673
14P	306692	Pilot Mounting Bracket, Electronic IID Unit	J1595
15P	062996	Lighter Tube (MV Units Only)	J1674*
16P	400607	Pilot Tube	J1959
17P	002654B	Hi Tension Wire, Electronic IID Unit	J1591
18P	307223	Pilot Shield	J1960*
1R	005282F	Refractory Tile, Common, Left & Right	J1961
2R	005283F	Refractory Tile, Front & Rear (185)	J1962*
2R	005284F	Refractory Tile, Front & Rear (265)	J1963*
2R	005285F	Refractory Tile, Front & Rear (335)	J1964
2R	005286F	Refractory Tile, Front & Rear (405)	J5292
3R	005287F	Retainer Kit for Refractory Tile (185)	J1966*
3R	005288F	Retainer Kit for Refractory Tile (265)	J1967*
3R	005289F	Retainer Kit for Refractory Tile (335)	J1968*
3R	005290F	Retainer Kit for Refractory Tile (405)	J1969*
1V	006696	Indoor Stack Kit (Includes inner adapter panel) (185)	J1441
1V	006697	Indoor Stack Kit (Includes inner adapter panel) (265)	J1443
1V	006698	Indoor Stack Kit (Includes inner adapter panel) (335)	J1445
1V	006699	Indoor Stack Kit (Includes inner adapter panel) (405)	J1447
3V	007990	"Pagoda" Top (185)	J1978*
3V	007991	"Pagoda" Top (265)	J1979*
3V	007991	"Pagoda" Top (335)	J1980*
3V	007993	"Pagoda" Top (405)	J1981*
1S	005303F	Jacket Top (Louvered) (185)	J1982*
1S	005304F	Jacket Top (Louvered) (265)	J1983*
1S	005305F	Jacket Top (Louvered) (335)	J1984*
1S	005306F	Jacket Top (Louvered) (405)	J1985*
2S	005307F	Flue Collector (185)	J1986*
2S	005308F	Flue Collector (265)	J1987*
2S	005309F	Flue Collector (335)	J1988*
2S	005310F	Flue Collector (405)	J1989*
11S	005198	Poolstat Cover/Lock	J1990*
12S	005394F	Up Front Control Panel	J1995*
	004690B	Conversion Kit - Natural to Propane (185) Millivolt Pilot	J1482
	004690B	Conversion Kit - Natural to Propane (265) Millivolt Pilot	J1482
	004692F	Conversion Kit - Natural to Propane (335) Millivolt Pilot	J1578
	004692F	Conversion Kit - Natural to Propane (405) Millivolt Pilot	J1578
	004691F	Conversion Kit - Propane to Natural (185) Millivolt Pilot	J1483
	004691F	Conversion Kit - Propane to Natural (265) Millivolt Pilot	J1483
	004693F	Conversion Kit - Propane to Natural (335) Millivolt Pilot	J1484
	004693F	Conversion Kit - Propane to Natural (405) Millivolt Pilot	J1484

Gas conversions are to be done only by a qualified agency.

***Non-Stock Item**

RAYPAK RP2100 P-R185A to P-R405A Capron Headers

Complete Product on Page 162

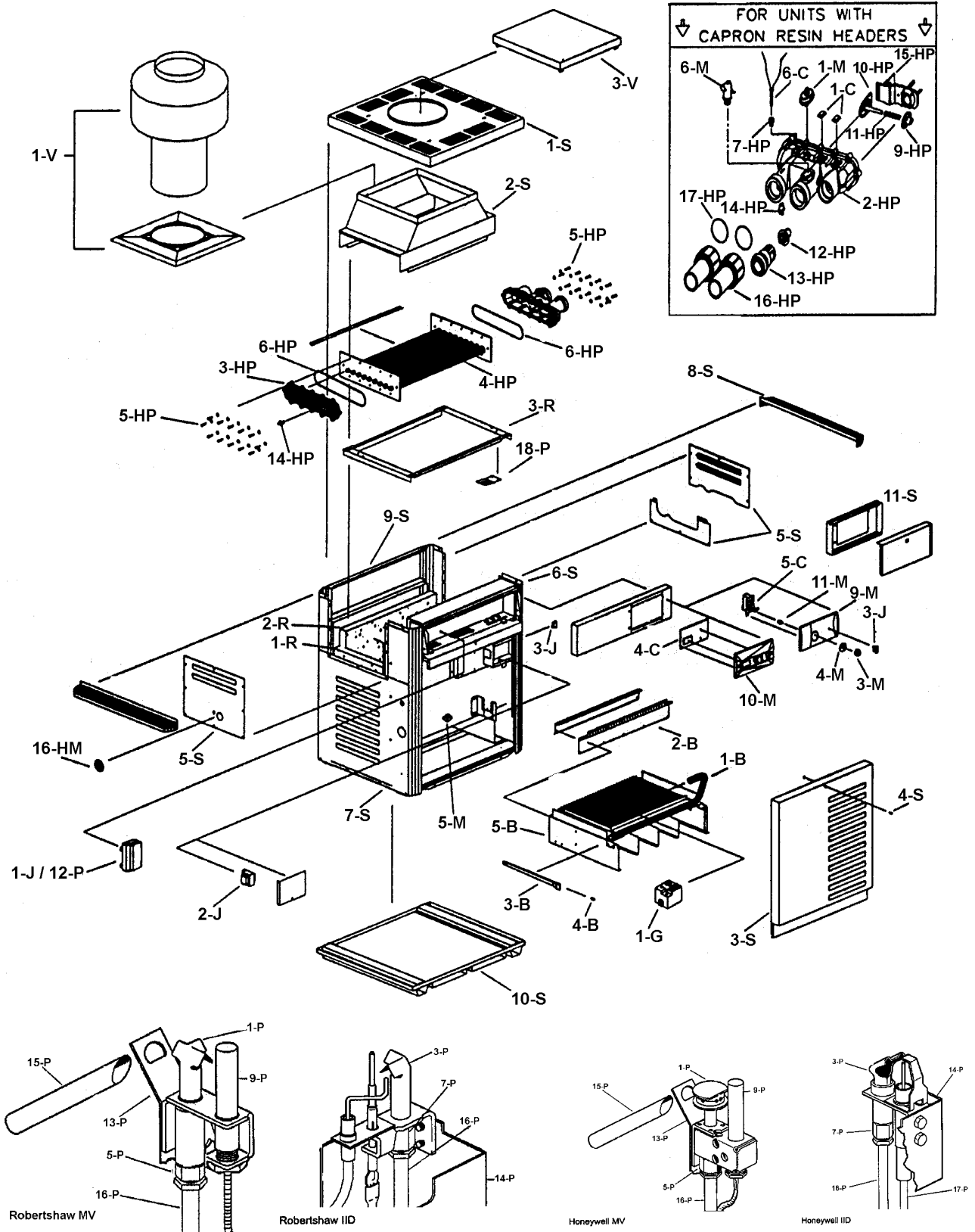

RAYPAK RP2100
P-R185A to P-R405A Capron Headers

KEY	MFG. NO.	DESCRIPTION		ITEM NO.
1-B	005213F	Burner Tray w/ Burners	(185)	J5218*
1-B	005214F	Burner Tray w/ Burners	(265)	J5220*
1-B	005215F	Burner Tray w/ Burners	(335)	J1903
1-B	005216F	Burner Tray w/ Burners	(405)	J5224*
---	005217F	Burner Tray w/o Burners	(185)	J5226*
---	005218F	Burner Tray w/o Burners	(265)	J5228*
---	005219F	Burner Tray w/o Burners	(335)	J5230*
---	005220F	Burner Tray w/o Burners	(405)	J5232*
2-B	005237F	Burner Spacer/ Hold Down Kit	(185)	J5234*
2-B	005238F	Burner Spacer/ Hold Down Kit	(265)	J5236*
2-B	005239F	Burner Spacer/ Hold Down Kit	(335)	J5238*
2-B	005240F	Burner Spacer/ Hold Down Kit	(405)	J5240*
3-B	301210	Burner		J1529**
4-B	350080	Burner Orifice Nat.		J1530**
4-B	350083	Burner Orifice Pro.		J1531**
**(13 needed for 185, 19 needed for 265, 24 needed for 335, 29 needed for 405)				
5-B	005265F	Burner Tray w/o Manifold or Burners	(185)	J5242*
5-B	005266F	Burner Tray w/o Manifold or Burners	(265)	J5244*
5-B	005267F	Burner Tray w/o Manifold or Burners	(335)	J5246*
5-B	005268F	Burner Tray w/o Manifold or Burners	(405)	J5248
1-C	006725F	Thermostat Auto Reset 135 Degrees Surface Mount		J5190
4-C	010253F	P.C. Board Control IID		J1947
5-C	600827B	Thermostat Control MV, Mechanical		J1555
6-C	006701F	Thermostat Sensor IID		J5212
1-G	003898F	Combination Valve, MV - Nat.		J1538
----	003899F	Combination Valve, MV - Pro.		J1539
----	003900F	Combination Valve, IID - Nat.		J1569
----	004306F	Combination Valve, IID - Pro.		J1570
1-HP	006702F	Heat Exchanger Assembly, Complete	(185)	J5250
1-HP	006703F	Heat Exchanger Assembly, Complete	(265)	J5252*
1-HP	006704F	Heat Exchanger Assembly, Complete	(335)	J5254*
1-HP	006705F	Heat Exchanger Assembly, Complete	(405)	J5256
2-HP	006706F	Inlet / Outlet Header (Includes O-Ring Gasket)		J5196
3-HP	006707F	Return Header (Includes O-Ring Gasket)		J5198
4-HP	006708F	Tube Bundle	(185)	J5258
4-HP	006709F	Tube Bundle	(265)	J5260
4-HP	006710F	Tube Bundle	(335)	J5262
4-HP	006711F	Tube Bundle	(405)	J5264
5-HP	006712F	Bolt Kit		J5206
6-HP	006713F	O-Ring Gasket (2 needed)		J5202

*Non-Stock Item

RAYPAK RP2100
P-R185A to P-R405A Capron Headers

KEY	MFG. NO.	DESCRIPTION	ITEM NO.
7-HP	006714F	Sensor Adapter Digital, Electronic (Jaco Fitting)	J5216
----	006805F	Sensor Well Millivolt	J5192
8-HP	006715F	Bypass Kit	J5266
9-HP	006716F	Bypass Valve	J5268
10-HP	006717F	Bypass Dam / Shaft	J5270
11-HP	006750F	Bypass Spring (185)	J5274
11-HP	006718F	Bypass Spring (265-405)	J5274
12-HP	006719F	Unitherm Governor	J5194
13-HP	006720F	Unitherm Governor Plug	J5276
14-HP	006721F	Drain Plug	J5200
15-HP	006722F	Inlet / Outlet Header Dam	J5278
16-HP	006723F	2" PVC Connector & Nut (2 needed)	J5280
17-HP	006724F	O-Ring (2 needed)	J5204
1-J	004817B	Ignition Control, IID - Nat.	J1585
1-J	004818B	Ignition Control, IID - Pro.	J1587
2-J	006736F	Transformer 120/240/24V	J5214
3-J	650902	Rocker Switch (Millivolt Only)	J1689
1-M	006737F	Pressure Switch	J5188
3-M	800303	Thermostat Knob	J1691
4-M	305138	Knobstop	J1579
5-M	005899F	Thermal Fuse	J1692
8-M	005269F	Wire / Harness, Millivolt	J1693
8-M	006738F	Wire / Harness, IID	J5284
9-M	005291F	Control Panel, MV	J1696
10-M	006739F	Control Panel, IID (Includes Switch Decal)	J5286
11-M	800307	Thermostat Shaft, MV	J1698
1-P	600525B	Pilot, Nat. - MV	J1536
1-P	600575B	Pilot, Pro. - MV	J1537
3-P	002003F	Pilot, Nat. - IID	J1590
3-P	002003F	Pilot, Pro. - IID (Old # 002064F)	J1590
5-P	003901F	Pilot Orifice, Nat. - MV	J1628
5-P	003902F	Pilot Orifice, Pro. - MV	J1571
7-P	003903F	Pilot Orifice, Nat. - IID	J1572
7-P	004308F	Pilot Orifice, Pro. - IID	J1576
9-P	600019B	Pilot Generator, MV	J1534
12-P	004817B	Ignition Control, Nat. - IID	J1585
12-P	004818B	Ignition Control, Pro. - IID	J1587
13-P	306693	Pilot MTG Bracket, MV	J1673
14-P	306692	Pilot MTG Bracket, IID	J1595
15-P	062996	Lighter Tube (MV Only)	J1674*
16-P	004078F	Pilot Tube	J1573
17-P	002654B	Hi Tension Wire, IID	J1591
18-P	307223	Pilot Shield	J5290*

*Non-Stock Item

RAYPAK RP2100
P-R185A to P-R405A Capron Headers

KEY	MFG. NO.	DESCRIPTION	ITEM NO.
1-R	005282F	Refractory Common (Left & Right)	J1961
2-R	005283F	Refractory Uncommon (Front & Rear)	J1962*
2-R	005284F	Refractory Uncommon (Front & Rear)	J1963*
2-R	005285F	Refractory Uncommon (Front & Rear)	J1964
2-R	005286F	Refractory Uncommon (Front & Rear)	J5292
3-R	005287F	Refractory Retainer Kit (185)	J5294*
3-R	005288F	Refractory Retainer Kit (265)	J5296*
3-R	005289F	Refractory Retainer Kit (335)	J5298*
3-R	005290F	Refractory Retainer Kit (405)	J5300*
1-S	005303F	Jacket Top (Louvered) (185)	J1982*
1-S	005304F	Jacket Top (Louvered) (265)	J1983*
1-S	005305F	Jacket Top (Louvered) (335)	J1984*
1-S	005306F	Jacket Top (Louvered) (405)	J1985*
2-S	006740F	Flue Collector (185)	J5302*
2-S	006741F	Flue Collector (265)	J5304*
2-S	006742F	Flue Collector (335)	J5306*
2-S	006743F	Flue Collector (405)	J5308*
3-S	005315F	Door Assembly (185)	J5310*
3-S	005316F	Door Assembly (265)	J5312*
3-S	005317F	Door Assembly (335)	J5314*
3-S	005318F	Door Assembly (405)	J5316*
4-S	006744F	Screw & Retainer	J5318
5-S	006745F	Access Panel Set (3 pieces)	J5320*
6-S	005300F	Side Panel Right	J5322*
7-S	005301F	Side Panel Left	J5324*
8-S	005302F	Side Panel Cap	J5326*
9-S	005278F	Rear Panel Kit (185)	J5328*
9-S	005279F	Rear Panel Kit (265)	J5330*
9-S	005280F	Rear Panel Kit (335)	J5332*
9-S	005281F	Rear Panel Kit (405)	J5334*
10-S	005182	Sub-Base for Combustible Flooring (185)	J5336*
10-S	005183	Sub-Base for Combustible Flooring (265)	J5338*
10-S	005184	Sub-Base for Combustible Flooring (335)	J5340*
10-S	005185	Sub-Base for Combustible Flooring (405)	J5342
11-S	005198	Poolstat Cover / Lock	J1990*
12-S	005294F	High Limit Cover	J5344*
1-V	006696	Indoor Stack (Includes inner adapter panel) (185)	J1441
1-V	006697	Indoor Stack (Includes inner adapter panel) (265)	J1443
1-V	006698	Indoor Stack (Includes inner adapter panel) (335)	J1445
1-V	006699	Indoor Stack (Includes inner adapter panel) (405)	J1447
3-V	065310	"Pagoda" Top (185)	J1978*
3-V	065312	"Pagoda" Top (265)	J1980*
3-V	065336	"Pagoda" Top (335)	J5346*
3-V	065311	"Pagoda" Top (405)	J1981*

*Non-Stock Item

TELEDYNE LAARS EPG, EPM SERIES ONE HEATERS

KEY	MFG NO.	DESCRIPTION	ITEM NO.
1A	W0036901	Pilot Generator Only, R/S TP-75, 32"	J2257
1A	W0012500	Pilot Generator Only, G/C <i>(For heaters w/G/C Pilot Burner/Generator Assy)</i>	J2257
1B	R0027500	Pilot Burner/Generator Assy., R/S Nat. - Universal	J2056
1B	R0027600	Pilot Burner/Generator Assy., R/S Pro. - Universal	J2058
2	W0018800	Lighter Tube Orifice, Natural	J2060
2	W0018900	Lighter Tube Orifice, Propane	J2062
2	W0016200	Visoflame Lighter Tube	J2135
—	10369600	Visoflame Tubing	J2285*
2A	R0037000	Pilot Tubing	J2248
3	R0027300	Gas Valve, R/S 7000 Natural <i>(For Heaters w/ Serial #8744591 & Above)</i>	J2262
3	R0027400	Gas Valve, R/S 7000 Propane <i>(For Heaters w/ Serial #8744310 & Above)</i>	J2263
3A	R0027700	Gas Valve Replacement Kit - Nat (G/C to R/S) <i>(Serial #8744590 & Below)</i>	J2262
3A	R0027800	Gas Valve Replacement Kit - Pro (G/C to R/S) <i>(Serial #8744309 & Below)</i>	J2263
4	L0032200	Orifice, Natural Gas	J2076
4	L0032900	Orifice, Propane Gas	J2078
5	10457200	Burner, Main w/ Pilot Bracket	J2213
6	L0052300	Burner, Main	J2289
7	10580500	Plate Assembly	J2296
7A	10456300	Thermostat Mounting Plate, Mechanical Type	J6610
7B	H0105300	Thermostat Dial	J2297
8	R0022700	Hi-Limit Switch, 135 Degree	J2080
9	R0023000	Hi-Limit Switch, 150 Degree	J2082
10	R0012800	Redundant Hi-Limit Switch, 275 Degree (105235)	J2244
11	R0318800	(EPG) Temperature Control, Mechanical	J2071
11	R0058200	(EPG) Temperature Control, 70-110 Degree (E-00971) Solid State	J2094
11	R0015600	(EPM) Temperature Control Assy. Elec/MV (E-01104)	J2298
11A	R0011800	(EPM) Temperature Sensor Assembly	J2096
12	10444900	Protector Sleeve, Bulb	J2251
13	10457800	Wire Harness (EPG)	J2025
13	10580600	Wire Harness (EPM)	J2299
14	E0094500	Knob, Pointer	J2092
15	10456700	Stop Plate, Temp-Lok	J2311
16	R0013200	Pressure Switch, 2 PSI, Standard (104088-02)	J2106
16	R0011300	Pressure Switch, 1 PSI, Consult Factory (104088-01)	J2105
16	R0013000	Pressure Switch, 3 PSI, Consult Factory (104088-03)	J2312
17	10418400	Hi-Limit Switch Retainer Clip	J2313*
—	S0098900	Hi-Limit Switch Retainer	J2314*
18	10418300	Cover, Hi-Limit Switches	J2315*
19	E0116400	O-Ring (Temperature Control Bulb)	J2184
20	R0099800	Rocker Switch	J2956
20	R0094100	On/Off Toggle Switch (E-00770)	J2108
20A	S0070000	Gasket, Temperature Control	J2316

* Parts Not Available When Out

*Non-Stock Item

TELEDYNE LAARS EPG, EPM SERIES ONE HEATERS

(1990-1992)

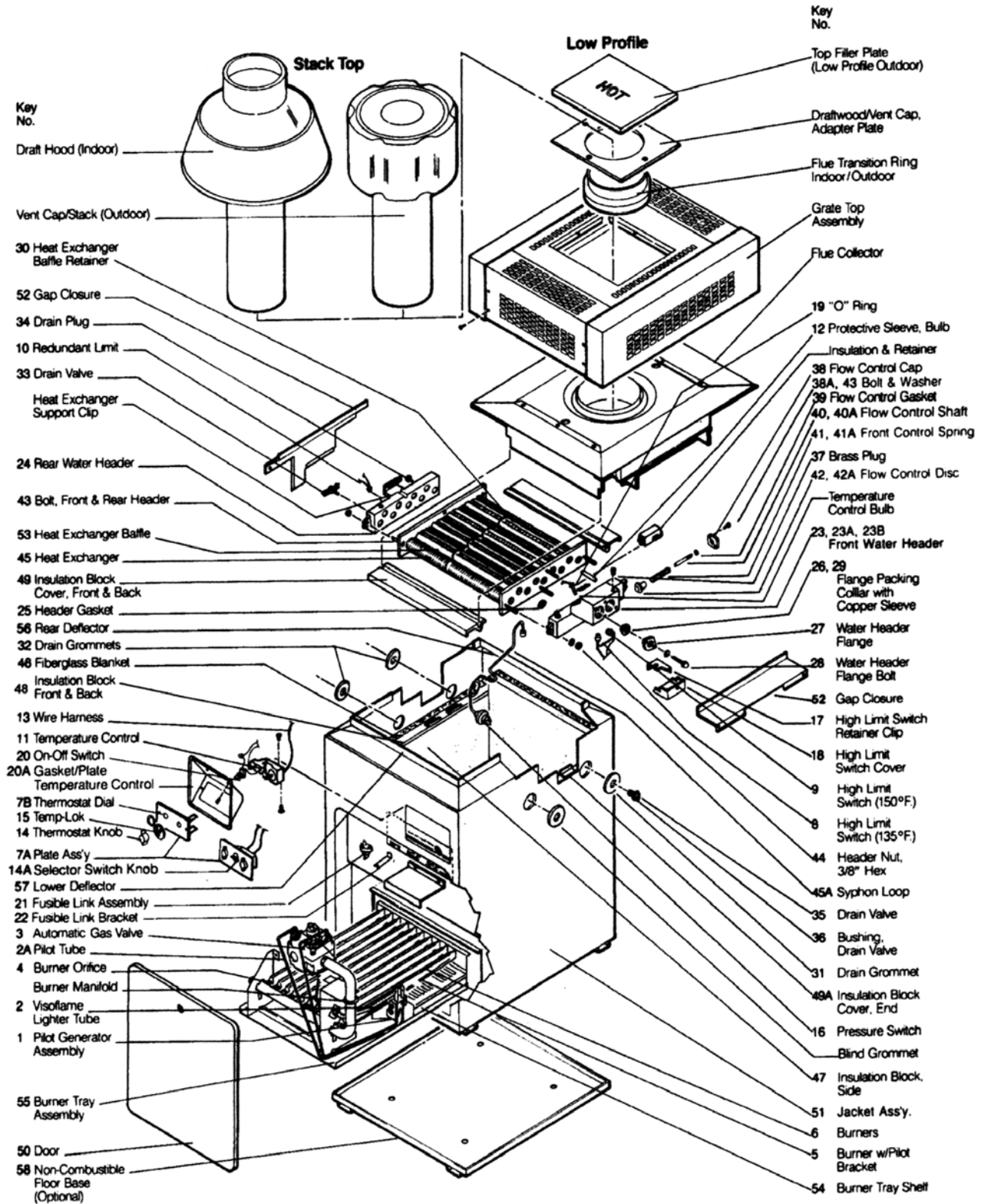

TELEDYNE LAARS EPG, EPM SERIES ONE HEATERS

KEY	MFG NO.	DESCRIPTION	ITEM NO.
21	R0012200	Fusible Link Assy. (E-00994)	J2131
22	10479900	Fusible Link, Bracket	J2317
23	R0058400	In/Out Header, 1-1/2" Cast Iron (Casting S-00686)	J2109
23A	R0054700	In/Out Header, 1-1/2" Bronze (S-00760)	J2318*
23B	R0056400	In/Out Header, 2" Cast Iron	J2266
23B	R0016800	Inlet/Outlet Header, 2" Bronze (S-00797)	J2319
24	R0058300	Return Header (Casting S-00688)	J2117
24A	R0054600	Return Header Bronze (S-00759)	J2320
25	R0050800	Header Gasket (S-00708)	(Set of 18) J2120
26	R0021100	Packing Collar & Gasket for Flange, 1-1/2"	(Set of 2) J2122
26A	S0078000	Flange Gasket, 2"	J2322
27	R0031900	Flange Kit, 1-1/2"	(Set of 2) J2124
27A	R0055000	Flange Kit, 2"	(Set of 2) J2268
28	F0031700	Flange Bolts, 2" Long	J2192
29A	S0078200	Sleeve (2") Adapter	J2326
30	S0083900	Clip for Tube Baffles	J2327
31	S0098800	Grommet for Drain Plug (7/8" Hole)	J2328*
33	P0058700	Drain Cock, Return Header	V4651
34	P0026800	Drain Plug, Return Header	V5102
35	P0058700	Drain Cock, In/Out Header	V4651
36	P0018500	Brass Reducer Bushing, 1/2" x 1/4", MPT x FPT	V5212
37	P0027000	Brass Pipe Plug 3/4", In/Out Header	V5107
38	10452201	Flow Control Cap (Casting S00691)	J2031
38A	F0031700	Bolt 3/8-16 x 1" Hex Head	(2 needed) J2192
39	R0011400	Flow Control Gasket	J2247
40	S0079800	Flow Control Shaft	J2201
41A	S0079900	Flow Control Valve Spring, Purple	(125) J2271
41	S0061400	Flow Control Valve Spring, White	(175) J2161
41	S0061300	Flow Control Valve Spring, Red	(250) J2160
41	S0061200	Flow Control Valve Spring, Blue	(325) J2159
41	S0070100	Flow Control Valve Spring, Black	(400) J2155
42	R0011500	Flow Control Disc	J2183
42A	S0079500	Flow Control Disc F/2" Header Only (Use J2183 when out)	J2267*
43	F0029600	Header Bolt, 2-1/2", Rd Hd Sq Neck	J2190
43	F0028300	Header Bolt, 2-1/2", (Front) Rd Hd Sq Neck	J2190
43	F0031800	Header Bolt, 2-1/2", Csk, Sq Neck	J2190
43	F0011100	Washer for Header Bolt	J2275*
44	F0003100	Nut for Header	J2276*

*Non-Stock Item

TELEDYNE LAARS EPG, EPM SERIES ONE HEATERS

KEY	MFG NO.	DESCRIPTION		ITEM NO.
45	R0018101	Heat Exchanger Tube Assy - 10451801	(125)	J2030
45	R0018102	Heat Exchanger Tube Assy - 10451802	(175)	J2032
45	R0018103	Heat Exchanger Tube Assy - 10451803	(250)	J2034
45	R0018104	Heat Exchanger Tube Assy - 10451804	(325)	J2036
45	R0018105	Heat Exchanger Tube Assy - 10451805	(400)	J2038
45A	10545200	Syphon Loop Tube for Pressure Switch		J2127
46	T0002000	Insulation, Fiberglass Blanket for Sides		J2041*
47	T0021400	Insulation, Block, Sides, 22-3/8" x 16-1/2"	(All)	J2047*
48	T0021501	Insulation, Block, Front, 9-1/8" x 18-9/16"	(125)	J2065*
48	T0021502	Insulation, Block, Front, 12-1/8" x 18-9/16"	(175)	J2051*
48	T0021503	Insulation, Block, Front, 16-5/8" x 18-9/16"	(250)	J2045*
48	T0021504	Insulation, Block, Front, 20-7/8" x 18-9/16"	(325)	J2055*
48	T0021505	Insulation, Block, Front, 25-1/8" x 18-9/16"	(400)	J2057*
48	T0021601	Insulation, Block, Rear, 9-1/8" x 22-13/16"	(125)	J2043*
48	T0021602	Insulation, Block, Rear, 12-1/8" x 22-13/16"	(175)	J2059*
48	T0021603	Insulation, Block, Rear, 16-5/8" x 22-13/16"	(250)	J2049*
48	T0021604	Insulation, Block, Rear, 20-7/8" x 22-13/16"	(325)	J2053*
48	T0021605	Insulation, Block, Rear, 25-7/8" x 22-13/16"	(400)	J2061*
--	R0325301	Replacement Firebrick Kit - Complete	(125)	J6121*
--	R0325302	Replacement Firebrick Kit - Complete	(175)	J6123
--	R0325303	Replacement Firebrick Kit - Complete	(250)	J6125
--	R0325304	Replacement Firebrick Kit - Complete	(325)	J6127
--	R0325305	Replacement Firebrick Kit - Complete	(400)	J6129
53	10697401	Baffle for Heat Exchanger, 9-1/16" (8 Needed)	(125)	J2939
53	10697402	Baffle for Heat Exchanger, 12-1/16" (8 Needed)	(175)	J2278*
53	10697403	Baffle for Heat Exchanger, 16-9/16" (8 Needed)	(250)	J2279
53	10697404	Baffle for Heat Exchanger, 10-7/16" (8 Needed)	(325)	J2281
53	10697405	Baffle for Heat Exchanger, 12-15/16" (8 Needed)	(400)	J2282
55	10578001	Burner Tray Assembly - Natural	(125)	J2300*
55	10578002	Burner Tray Assembly - Natural	(175)	J2301
55	10578003	Burner Tray Assembly - Natural	(250)	J2302
55	10578004	Burner Tray Assembly - Natural	(325)	J2303
55	10578005	Burner Tray Assembly - Natural	(400)	J2304*
55	10578101	Burner Tray Assembly - Propane	(125)	J2305
55	10578102	Burner Tray Assembly - Propane	(175)	J2306
55	10578103	Burner Tray Assembly - Propane	(250)	J2307
55	10578104	Burner Tray Assembly - Propane	(325)	J2308
55	10578105	Burner Tray Assembly - Propane	(400)	J2309
--	R0040400	Pressure Relief Valve, 3/4", 75 PSI (A-00633)		J2128

*Non-Stock Item

TELEDYNE LAARS LITE GAS HEATERS

Pilot Gas System - LLG

KEY	MFG. NO	DESCRIPTION	ITEM NO.
1	R0099200	Pilot, Main Burner Assembly, LPG	J2905
1	R0099100	Pilot, Main Burner Assembly, NAT	J2904
2	R0096700	Pilot Burner, NAT	J2993
2	R0096600	Pilot Burner, LPG	J2994
3	W0036901	Pilot Generator	J2257
4	R0011600	Ceramic Insulator Assembly	J2089
5	10457500	Burner, Main w/Pilot Bracket	J2913
6	R0099000	High Voltage Lead Assembly	J6100*
7	R0037000	Pilot Tubing	J2248
8	R0096800	Piezo Lighter Assembly	J2390
9	R0097000	Piezo Lighter Knob	J2391*

Main Gas Assembly - LLG (Millivolt)

11	R0098601	Burner Tray Assembly, NAT - 125	J1037*
11	R0098602	Burner Tray Assembly, NAT - 175	J1039*
11	R0098603	Burner Tray Assembly, NAT - 250	J1040
11	R0098604	Burner Tray Assembly, NAT - 325	J1041*
11	R0098605	Burner Tray Assembly, NAT - 400	J1042
11	R0098701	Burner Tray Assembly, LPG - 125	J1043*
11	R0098702	Burner Tray Assembly, LPG - 175	J1044*
11	R0098703	Burner Tray Assembly, LPG - 250	J1045
11	R0098704	Burner Tray Assembly, LPG - 325	J1046*
11	R0098705	Burner Tray Assembly, LPG - 400	J1047*
13	R0096400	Gas Valve, NAT - LLG	J2992
13	R0096900	Gas Valve, LPG - LLG	J2991

Main Gas Assembly - LLD (Electronic)

10	R0317200	Ignitor - LLD	J2883
---	R00334300	Flame Rectification Upgrade Kit	J2363
11	R0316901	Burner Tray Assembly, NAT - 125	J6620*
11	R0316902	Burner Tray Assembly, NAT - 175	J6622
11	R0316903	Burner Tray Assembly, NAT - 250	J6624*
11	R0316904	Burner Tray Assembly, NAT - 325	J6626*
11	R0316905	Burner Tray Assembly, NAT - 400	J6628*
11	R0319501	Burner Tray Assembly, LPG - 125	J6630
11	R0319502	Burner Tray Assembly, LPG - 175	J6632*
11	R0319503	Burner Tray Assembly, LPG - 250	J6634*
11	R0319504	Burner Tray Assembly, LPG - 325	J6636*
11	R0319505	Burner Tray Assembly, LPG - 400	J6638
13	R0317100	Gas Valve, NAT - LLD	J2880
13	R0319600	Gas Valve, LPG - LLD	J2882

Main Gas Assembly - MISC.

12	R0317001	Burner Tray, Shelf Only - 125	J2129*
12	R0317002	Burner Tray, Shelf Only - 175	J2132
12	R0317003	Burner Tray, Shelf Only - 250	J2134
12	R0317004	Burner Tray, Shelf Only - 325	J2136
12	R0317005	Burner Tray, Shelf Only - 400	J2138

*Non-Stock Item

TELEDYNE LAARS LITE GAS HEATERS
(1997 - Present)

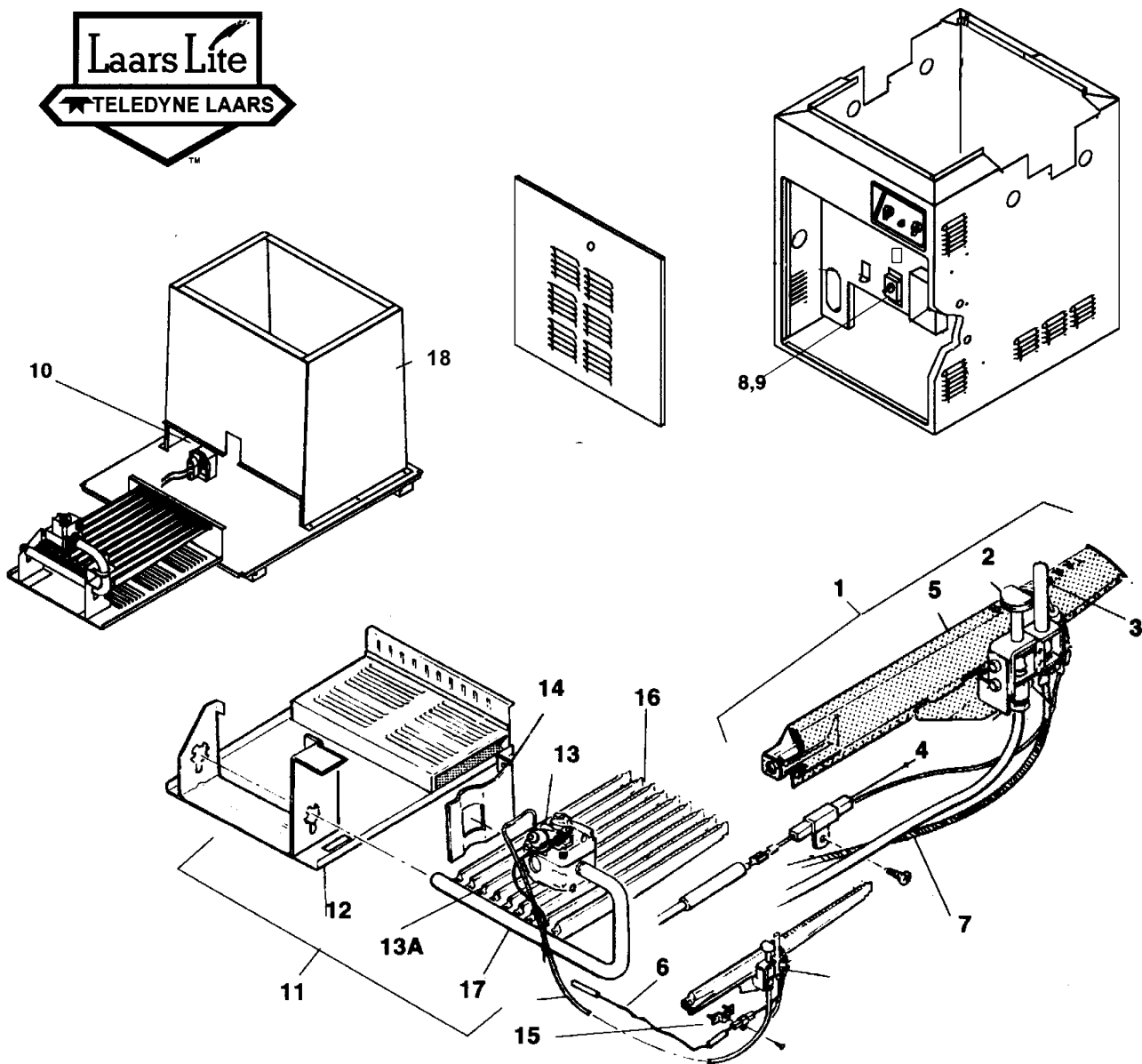

Main Gas Assembly - MISC. (Cont.)

KEY	MFG. NO	DESCRIPTION	ITEM NO.
13a	L0032200	Gas Orifice, NAT	J2076
13a	L0032900	Gas Orifice, LPG	J2078
14	10577200	Anti-Rotation Bracket	J6639*
15	10419200	Mounting Bracket Assembly	J2903
16	L0052300	Burner, Main	J2289
18	R0316701	Complete Chamber Assembly	(125) J6640*
18	R0316702	Complete Chamber Assembly	(175) J6642*
18	R0316703	Complete Chamber Assembly	(250) J6644*
18	R0316704	Complete Chamber Assembly	(325) J6646*
18	R0316705	Complete Chamber Assembly	(400) J6648*

*Non-Stock Item

TELEDYNE LAARS LITE GAS HEATERS

Water Systems

KEY	MFG. NO.	DESCRIPTION	ITEM NO.
27	R0011800	Temperature Sensor	J2096
28	10444900	Protector Sleeve Bulb	J2251
29	E0116400	O-Ring, Temperature Control Bulb	J2184
35	10447300	Retainer Bracket	J2948
36	F0009100	Retainer Bracket Screw	J6444*
---	R0313900	Redundant High - Limit - LLG (Not Shown)	J2886
41	R0023200	High - Limit Switch Assembly	J6110
42	R0022700	High - Limit Switch, 135* F	J2080
43	R0023000	High - Limit Switch, 150* F	J2082
44	10418400	High - Limit Switch Retainer Clip	J6682*
---	S0098900	High - Limit Switch Retainer Boot	J6684*
46	10418300	High - Limit Switch Cover	J6686*
47	10419300	High - Limit Switch Wire Harness	J2950
68	R0056400	Inlet/Outlet Header, 2" (Cast Iron)	J2266
68	R0016800	Inlet/Outlet Header, 2" (Bronze)	J2319
69	R0058300	Return Header (Cast Iron)	J2117
69	R0054600	Return Header (Bronze)	J2320
70	R0057000	Header Bolt Assembly	J6692*
71	F0046100	Bolt, 2-1/2" for Headers	J2190
72	F0011100	Washer for Headers	J2275*
73	F0003100	Nut for Headers	J6696*
74	R0050800	Header Gasket Assembly (Set of 18)	J2120
75	R0055000	Flange & Gasket Assembly (Set of 2)	J2268
76	10573500	Flange, 2"	J2324
77	S0078000	Flange Gasket, 2"	J2322
78	S0078200	Flange Sleeve, 2"	J2326
79	F0031700	Flange Bolt	J2192
80	S0078100	Flange Gasket, 1-1/2" - 2"	J2920
84	P0026800	Drain Plug	V4651
85	P0018500	Drain Plug Bushing	V5212
86	P0027000	Brass Plug, 3/4"	V5107
87	R0054900	By-Pass Assembly	J6698
88	S0074300	By-Pass Valve Rod	J6140
89	R0011500	By-Pass Valve Disc	J2183
90	10452200	By-Pass Valve Control Cap	J2031
91	S0079900	By-Pass Valve Spring, Purple (125)	J2271
91	S0061400	By-Pass Valve Spring, White (175)	J2161
91	S0061300	By-Pass Valve Spring, Red (250)	J2160
91	S0061200	By-Pass Valve Spring, Blue (325)	J2159
91	S0070100	By-Pass Valve Spring, Black (400)	J2155
92	R0011400	By-Pass Valve Gasket	J2247
93	R0018101	Heat Exchanger Assembly (125)	J2030
93	R0018102	Heat Exchanger Assembly (175)	J2032
93	R0018103	Heat Exchanger Assembly (250)	J2034
93	R0018104	Heat Exchanger Assembly (325)	J2036
93	R0018105	Heat Exchanger Assembly (400)	J2038

*Non-Stock Item

TELEDYNE LAARS LITE GAS HEATERS
(1997 - Present)

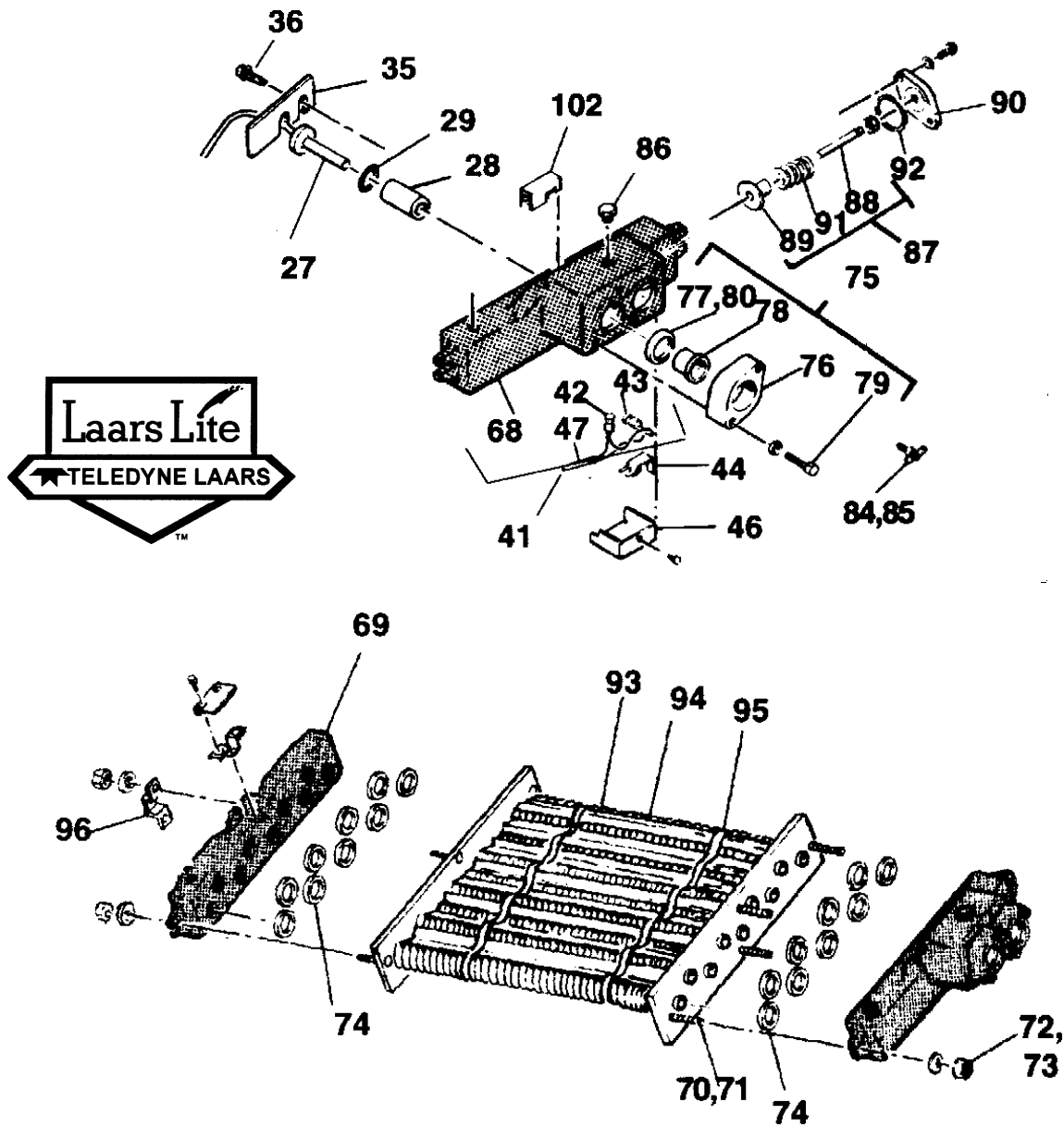

Water Systems (Cont.)

KEY	MFG NO.	DESCRIPTION	ITEM NO.
94	10697401	Baffle for Heat Exchanger (125)	J2939
94	10697402	Baffle for Heat Exchanger (175)	J2278*
94	10697403	Baffle for Heat Exchanger (250)	J2279
94	10697404	Baffle for Heat Exchanger (325)	J2281
94	10697405	Baffle for Heat Exchanger (400)	J2282
95	S0083900	Retainer for Baffle	J2327
96	10457000	Support for Heat Exchanger	J6142*
102	10462200	Insulation Retainer	J6650*

*Non-Stock Item

TELEDYNE LAARS LITE GAS HEATERS Electrical Systems

LLG (Millivolt)

KEY	MFG. NO.	DESCRIPTION	ITEM NO.
18	R0058200	Temperature Control Assembly - LLG	J2094
19	R0058000	Wire Harness (not shown)	J2299
20	10456300	Plate Assembly	J6610
21	R0099800	On-Off Switch	J2956

LLD (Electronic)

22	H0105300	Temperature Control Label	J2297
23	R0011700	Temperature Control Assembly - LLD	J2211
24	10457800	Wire Harness Assembly	J2025
25	10594600	Plate Assembly	J6672*
26	R0099900	Knob, Single Bar	J6108*

Misc. Components

30	R0010700	Thermostat Knob, Black	J2092
31	10583100	"Temp-Lok" Stop Plate	J2958
32	S0070000	Temperature Control Gasket	J2316
33	S0069800	Bezel	J6676*
34	F0033300	Stop Plate Screw	J6678*
37	R0097600	Pressure Switch & Siphon Loop Assembly	J2127
38	R0013200	Pressure Switch, 2 PSI	J2106
38	R0011300	Pressure Switch, 1 PSI	J2105
38	R0015500	Pressure Switch, 1-10 PSI	J2241
39	R0057800	Siphon Loop Assembly	J2127
40	R0313900	Redundant High-Limit - LLG	J2886
---	R0337400	Redundant High Limit Replacement Kit <i>(Use if Nuisance Tripping Occurs)</i>	J6608
48	R0012200	Fusible Link Assembly	J2131
49	10479900	Bracket for Fusible Link	J2317
50	R0097800	Terminal Block	J2975*
51	R0317500	Ignition Control Assembly - LLD	J2885
52	R0325200	Ignition Control - LLD	J2884
53	R0059800	Harness Assembly	J6680*
54	R0061100	Transformer (115V - 220 & 24V)	J2088
55	10451200	Ignition Control Panel	J2967
56	10480000	In-Line Fuse Assembly	J2968
56	R0012000	Fuse 3 Amp (5 Pack)	J6606
63	10561501	Outdoor Vent Cap (125)	J1081
63	10561502	Outdoor Vent Cap (175)	J1083
63	10561503	Outdoor Vent Cap (250)	J1085
63	10561504	Outdoor Vent Cap (325)	J1087
63	10561505	Outdoor Vent Cap (400)	J1089
64	10561401	Indoor Drafthood (125)	J1120
64	10561402	Indoor Drafthood (175)	J1122
64	10561403	Indoor Drafthood (250)	J1124
64	10561404	Indoor Drafthood (325)	J1126
64	10561405	Indoor Drafthood (400)	J1128

*Non-Stock Item

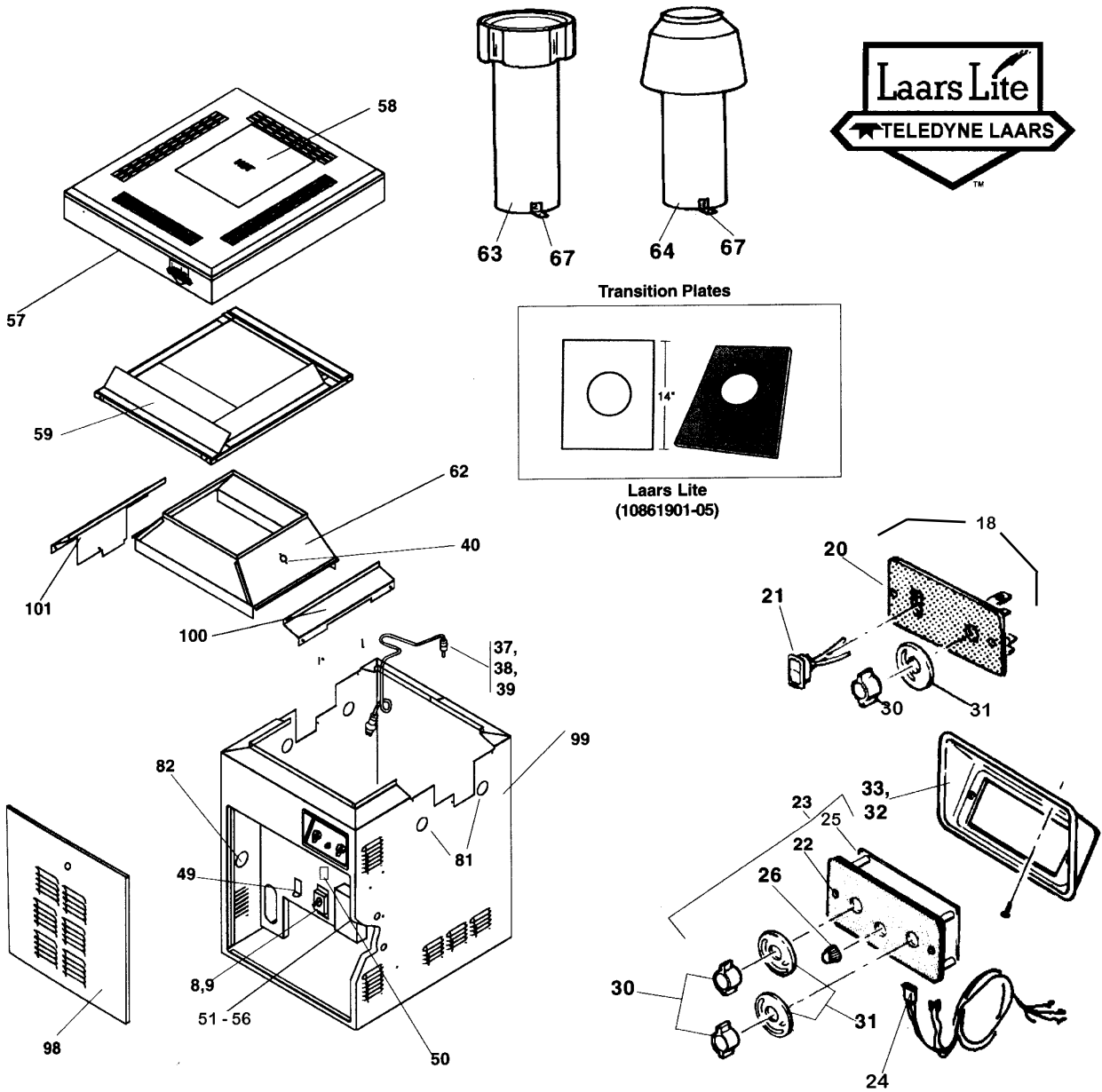

TELEDYNE LAARS LITE GAS HEATERS

KEY	MFG. NO.	DESCRIPTION	ITEM NO.
81	R0316300	Grommet for Drain Plug	J6652
82	S0071100	Grommet, Slitted	J6654
83	S0098700	Hole Plug	J6656
---	10861901	Flue Transition Plate (125)	J6660*
---	10861902	Flue Transition Plate (175)	J6662*
---	10861903	Flue Transition Plate (250)	J6664
---	10861904	Flue Transition Plate (325)	J6666*
---	10861905	Flue Transition Plate (400)	J6668*
---	R0040400	Pressure Relief Valve, 3/4" (75 psi)	J2128
---	X0021100	Touch-Up Spray Paint, Light Beige	J6310*

*Non-Stock Item

American Products Aqua-Lumin I & II Lights 438

Underwater Lights

AMERICAN PRODUCTS AQUA-LUMIN & AQUA-LUMIN II LIGHTS
Concrete & Vinyl Liner Models

Complete
 Product on
 Page 172

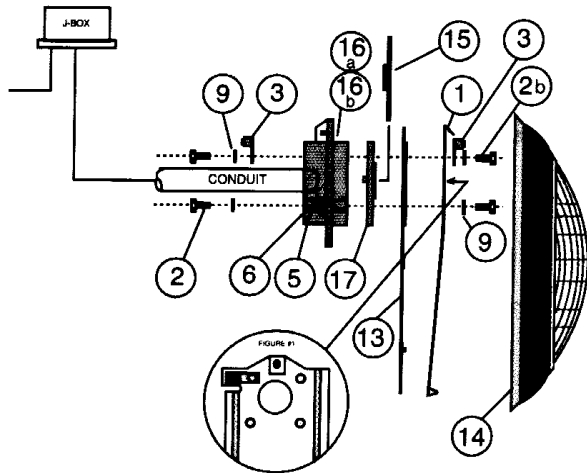

Concrete Installation

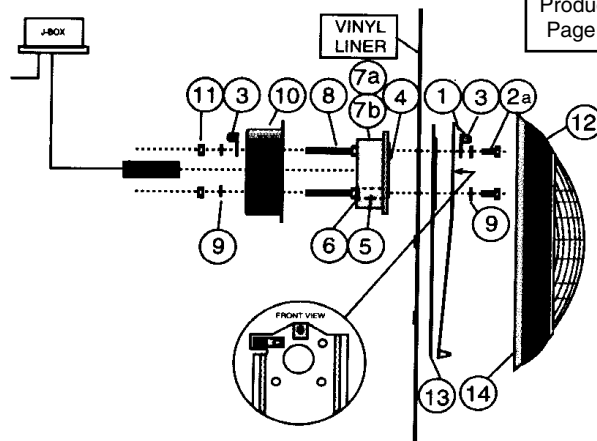

Vinyl Installation

KEY	MFG NO.	DESCRIPTION	ITEM NO.
1	78875100	Wall Mounting Bracket	O5054*
2a	98210800	Screw, Slotted Hex, 1/4-20, S.S.	O5052
2b	98105500	Bracket Mounting Bolt (6 needed)	O4047
3	98210500	Lug, Grounding / Bonding Lug Assembly	O5047*
4	87206300	Gasket, Sealing	O5079*
5	98218100	Standoff, Brass 1/4-20	O5051*
6	46815500	O-Ring	O4046*
7a	78872000	Mounting Hub, 3/4", Concrete	O5077*
7b	78872100	Mounting Hub, 1", Concrete	OBS
8	98216900	Stud, 1/4-20 x 2.250 Long	O5036*
9	98216800	Washer, Lock, 1/4, 18-8 S.S.	O5049*
10	78872500	Bracket Cup	O5076*
11	98201700	Nut, Hex 1/4-20, 18-8 S.S.	OBS
12	78889900	Pilot Screw, 10-24 x .375	O5058
13	78872400	Mounting Spacer (before 8/94)	O4037
13	78872600	Mounting Spacer (after 8/94)	O4038*
14	78882100	Housing Spacer	O4039
15	45360000	Gunite Shield	OBS
16a	47660002	Mounting Hub 3/4", Vinyl	OBS
16b	47660003	Mounting Hub 1", Vinyl	OBS
17	87450000	Hub Spacer	O4044

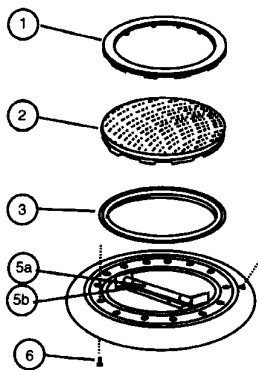

Light Assembly

Light Assembly Parts

KEY	MFG NO.	DESCRIPTION	ITEM NO.
1	78880400	Face Ring, White	O5056
2	78880300	Lens	O5053
3	78880200	Lens Seal	O5057
5a	78880800	Halogen Lamp, 12 Volt, 150 Watt	O5059
5b	78881100	Halogen Lamp, 120 Volt, 250 Watt	O1201
6	78881400	Sealing Screws (10 needed)	O5068
---	98211400	Nut, 1/4-20 Brass Plated Knurl	H8916
---	85016600	Weir Stop	L2030
---	78883700	AquaLumin II Colored Lens Kit (Set of 4)	O1117

Pac-Fab Full-Flow Valve 441

Pac-Fab Hi-Flow Valves 442

Pac-Fab Multiport Valves 443-444

Pac-Fab Slide Valves 445

Complete Product on Page 121

PENTAIR (PAC-FAB) FULL-FLOW VALVE

KEY	MFG NO.	DESCRIPTION	ITEM NO.
1	278006	Handle	H9400
2	275000	Screw	OBS
3	278020	Cap - Nut, 2 req.	H9404
4	278021	Cap Insert - Top	H9406
5	192039	O-Ring, Bunan, 2 req.	H9408
6	275300	O-Ring, Bunan 70, 2 req.	H9410
7	278004	Stem - Waste Seal	OBS
8	278019	Seal - Waste	H9414
9	271065	Spring, .42 o.d	H9416
10	270006	Spring, .24 o.d.	OBS
11	278002	Port - Diverter	OBS
12	270007	Body - 7-1/2" Centerline (Sand)	H9436*
12	270008	Body - 7-1/2" Centerline (D.E.)	H9438*
13	274430	Adapter - Bulkhead, 2 Required	OBS
14	274494	O-Ring - Bulkhead, 2 Required	H3371
15	274440	Nut, Adapter, 2 Required	J4526
16	278003	Shaft - 7.5" Valve	OBS
17	278018	Port - Block	OBS
18	278007	Stem	OBS
19	278022	Cap Insert - Bottom	H9428
--	270011	Shaft Assembly - (Consists of: Items 18, 17, 16, 11, 10, 9 and two 5's)	H9435*

* Items Not Sold Separately

**Full-Flow D.E. Valve
263011**

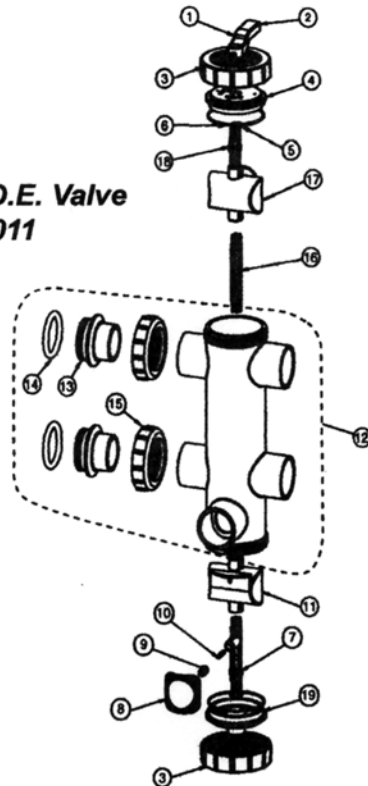

**Full-Flow Sand Valve
263010**

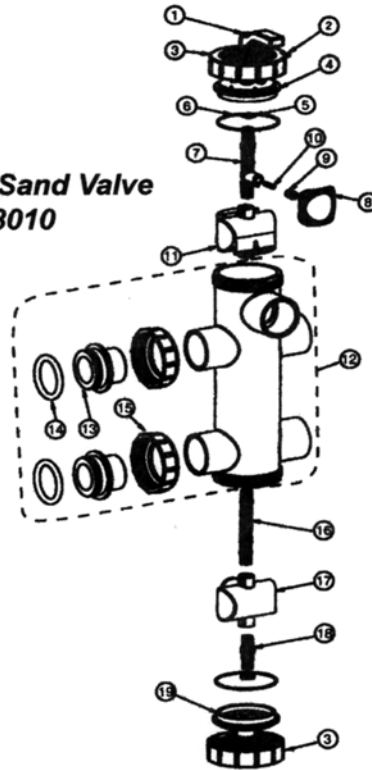

**purex
triton**

PENTAIR (PAC-FAB) HI-FLOW VALVES 1-1/2"
4-Way & 6-Way (Tagelus Filters)

Complete
 Product on
 Page 121

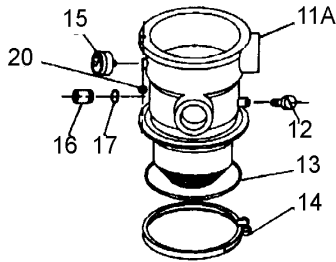
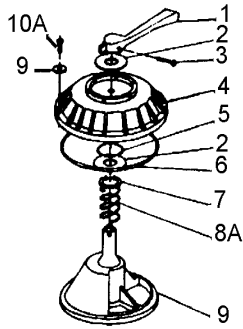

6" BUTTRESS STYLE VALVE

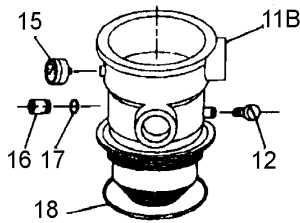

CLAMP STYLE VALVE

KEY	MFG NO.	DESCRIPTION	ITEM NO.
--	272531	Complete Top Half Assembly	K3619
1	272520	Handle	K3601
2	272505	Plastic Washer (2 needed)	K3602
3	272405	Screw, Handle	K3603
4	272527	Valve Top Only, Black	K3604
5	272511	O-Ring for Diverter Shaft	K3605
6	354053	O-Ring, Valve Top	K3606
7	272401	Washer, S.S. (before 5/1/92)	K3607
8	272400	Spring, 1-13/16" (before 5/1/92)	K3608
8A	272535	Spring, 1-3/8" (after 5/1/92)	K3609
9	272512	Diverter with Gasket	K3610
10	634598	Screw (6 needed)	K3611
10A	354541	Screw Hex Pan Head (6 req.)(after 4/94)	K4596
11A	272530	Valve Body w/Diffuser - Clamp Style	K3612*
11B	272538	Valve Body w/Diffuser - Threaded	K3613*
12	273512	Air Bleeder Screw with O-Ring	H4222
12	272515	Air Bleeder, Clamp Valves (before 3/93)	H3255
13	272541	O-Ring 3/16" x 4-5/8" ID	H4344
14	155526	Clamp, 6-1/2"	OBS
15	155050	Pressure Gauge - Back Mount	H7010
16	272550	Sight Glass with Vacuum Protector	K3618
17	271106	Gasket for Sight Glass	H3364
18	154493	O-Ring, Valve Body	H4044
19	272555	Washer - 9/16 S.S. (6 req.)(after 4/94)	H3691*
20	272554	Nut Serrated Flg S.S. (6 req.)(after 4/94)	H3693*

PAC-FAB HI-FLOW VALVE 2"
26-1049, 26-1050 & 26-1142

KEY	MFG NO.	DESCRIPTION	ITEM NO.
1	272520	Handle	K3601
2	272405	Screw, Handle	K3603
4	272402	Washer, Plastic	K3621
5	272412	Valve Top	K3622
6	272401	Washer, 1/32"	K3607
7	272400	Compression Spring	K3608
8	272406	Diverter O-Ring	H3328
9	272413	Diverter	K3623
10	272409	Seal for Diverter	K3624
11	272427	Gasket (Prior to 1/1/89)	OBS
12	154566	Sight Glass	K3626
17	272408	Hex Nut, 1/4"-20	OBS
18	272403	Screw, 1/4"-20	OBS
--	274407	Nut, Bulkhead Adaptor (2 needed)	H3369
--	274404	Adaptor, Bulkhead	H3374
--	274494	O-Ring, Bulkhead Adaptor (2 needed)	H3371
--	272422	Valve Top Assy (#1 thru #9)	K3628

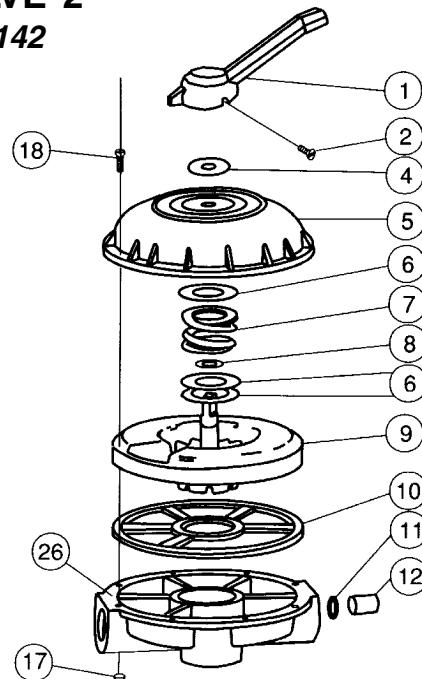

PENTAIR (PAC-FAB, PRAHER) MULTIPORT VALVES 1-1/2" Top Mount & Side Mount

Complete
Product on
Page 121

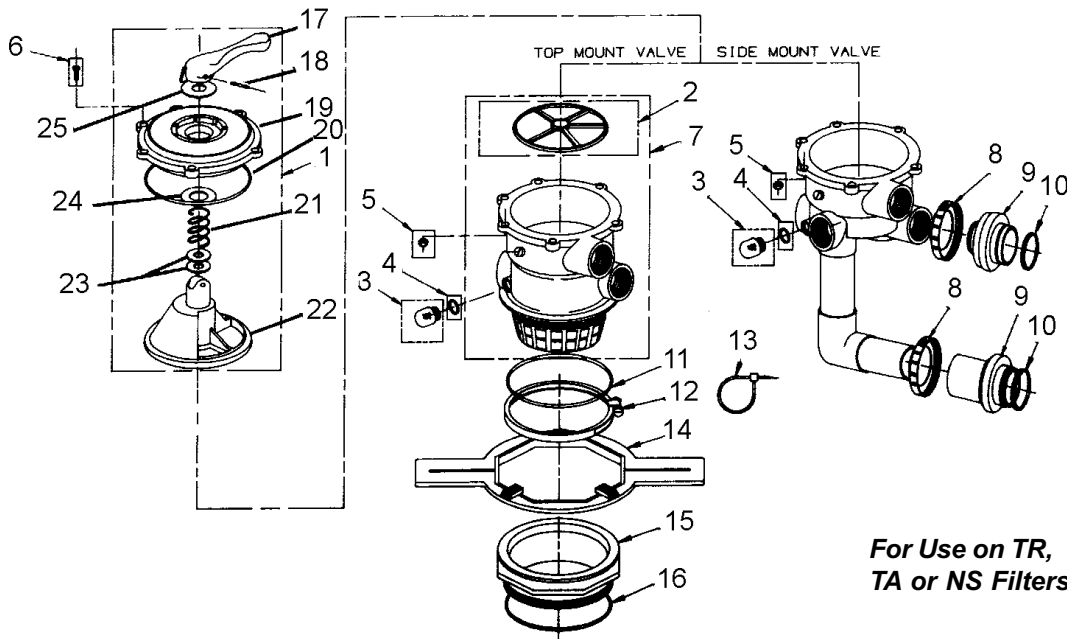

**For Use on TR,
TA or NS Filters**

KEY	MFG NO.	DESCRIPTION	ITEM NO.
1	271102	Top Valve Assembly, 1-1/2"	H3345
2	271104	Gasket for Diverter (Replaces #50141700)	H3344
3	272550	Sight Glass w/ Vacuum Protection (Old # 27-1107)	K3618
4	271106	Gasket for Sight Glass	H3364
5	271139	Nut, M6 Stainless Steel	H3365
6	152168	Screw, M6 x 1 (Replaces #27-1138)	H3368
7	271145	Body, Replacement w/Diffuser	H3376*
8	274407	Nut, Bulkhead Adaptor	H3369
9	274404	Adaptor, Valve (2 needed)	H3374
9	274651	Adaptor, Valve	H3375*
10	274494	O-Ring, Adaptor	H3371
11	272708	O-Ring, Valve Adaptor	OBS
12	155526	Clamp - Metal Screw Type	OBS
12	152162	Clamp - Plastic Snap Type	OBS
13	152163	Securing Tie	OBS
14	154513	Wrench, Flanged Valve Adaptor	OBS
15	155225	Adaptor, Flanged - Standard Thread	H4349
15	154555	Adaptor, Flanged - Buttress Thread	H4348
16	154493	O-Ring, Flanged Valve Adaptor	H4044
--	154966	90 Degree 1-1/2" Thd Barbed Ftg	OBS
--	711004	Worm Clamp, 1-1/2" Hose	H3384*
17	271156	Handle	H3358
18	271164	Pin for Handle	H3357
19	271158	Valve Top - White	H3383*
19	271165	Valve Top - Black	H3382
20	271103	O-Ring for Valve Top	H3381
21	271161	Valve Spring	H3351
22	271163	Valve Diffuser	H3380
23	271162	O-Ring, Stem	H3348
24	271160	Washer, Valve Spring	H3347
25	271157	Washer, Handle	H3346

PENTAIR (PAC-FAB, PRAHER) MULTIPOINT VALVES 2"
Top Mount & Side Mount

Complete Product on Page 121

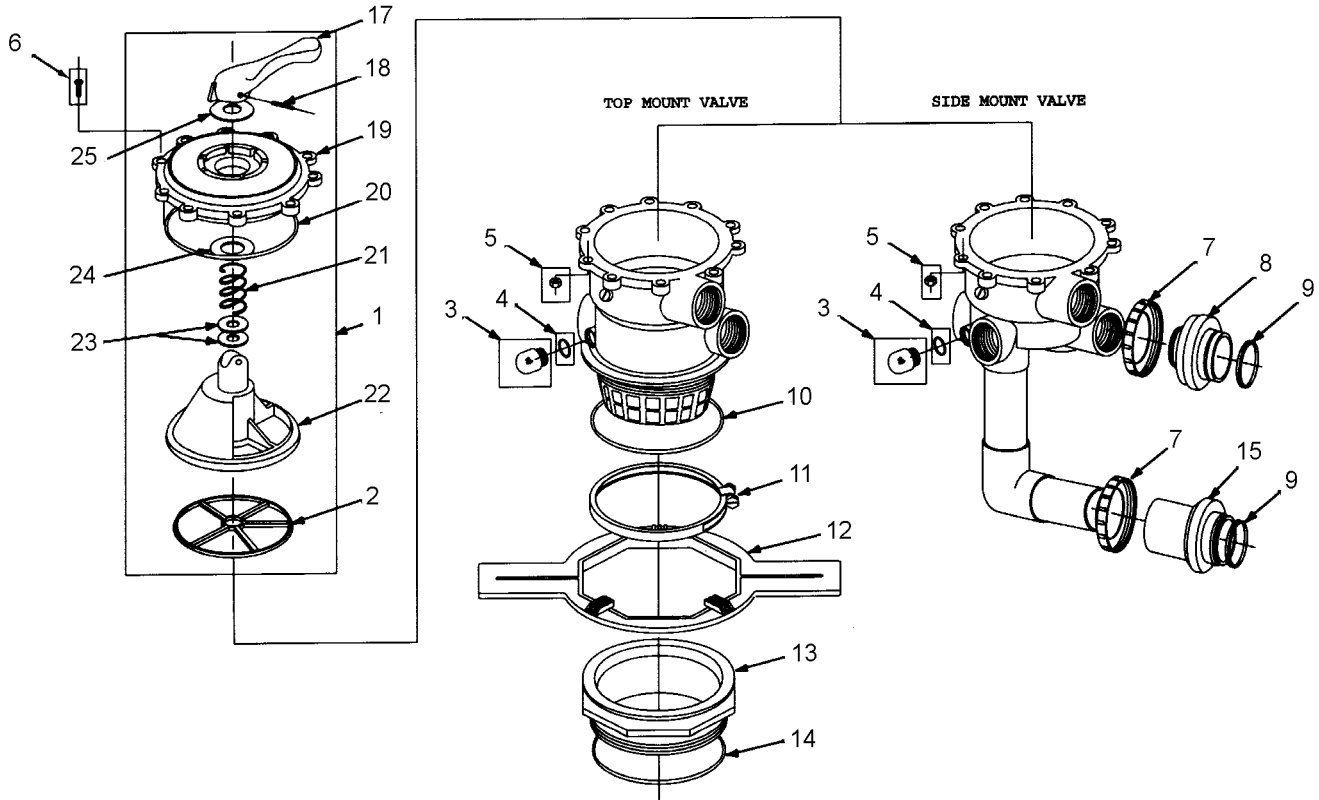

KEY	MFG NO.	DESCRIPTION	ITEM NO.
1	271152	Top Valve Assembly 2"	H3359
2	271148	Gasket, Diverter	H3360
3	272550	Sight Glass w/ Vacuum Protection (Old # 27-1107)	K3618
4	271106	Gasket, Sight Glass	H3364
5	271139	Nut, M6 Stainless Steel	H3365
6	152168	Screw, M6 x 1 (Old # 27-1138)	H3368
7	274407	Nut, Bulkhead Adaptor	H3369
8	274556	Adaptor, Valve, Threaded	H3372
9	274494	O-Ring for Adaptor	H3371
10	275333	O-Ring, Valve	H4345
11	152130	Band Assembly - Valve	OBS
12	151608	Wrench for Adaptor Flange	OBS
13	154514	Adaptor - Flange Buttress Thread	OBS
14	152501	O-Ring for Adaptor	H4351
15	274404	Adaptor - Valve, Slip	H3374
17	271156	Handle	H3358
18	271164	Pin for Handle	H3357
19	271166	Valve Top - White	H3356
19	271169	Valve Top - Black	H3355*
20	271151	O-Ring, Valve Top	H3354
21	271161	Valve Spring	H3351
22	271168	Valve Diffuser	H3350
23	271162	O-Ring, Stem	H3348
24	271160	Washer, Valve Spring	H3347
25	271157	Washer, Handle	H3346

Complete Product on Page 121

PENTAIR (PAC-FAB) PLASTIC SLIDE VALVE 2" New Style 26-1165 (1994)

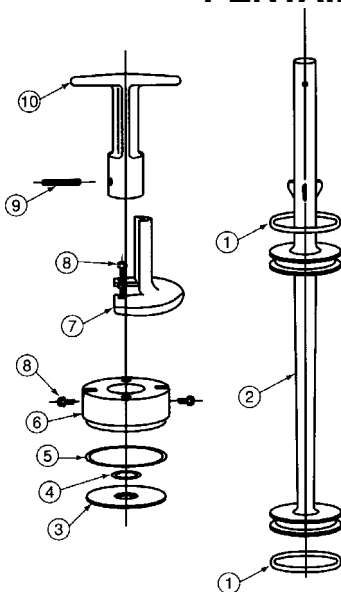

KEY	MFG NO.	DESCRIPTION	ITEM NO.
1	273090	O-Ring, 1-1/2" x 3/16" Dia.	H3332
2	273106	Piston Shaft	H3330
3	273102	Washer, 5/8" x 2-5/32" x 1/8"	OBS
4	272406	O-Ring, 9/16" x 3/32"	H3328
5	273062	O-Ring, 2-1/8" x 1/8" Dia.	H3338
6	273077	Plug, 5/8" x 2-3/8"	H3367*
7	273064	Position Bracket	H3340
8	273071	Screw, S.S.	H3343
9	273063	Pin, 1/8" x 1-1/8" Long S.S.	H3339
10	273089	Handle for Plastic Shaft, 5/8"	H3326
---	273241	Piston Rod Assembly	H3366

PENTAIR (PAC-FAB) PLASTIC SLIDE VALVE 2" Old Style 25-1165 (Prior to 1994)

Old Style 25-1165
(Prior to 1994)

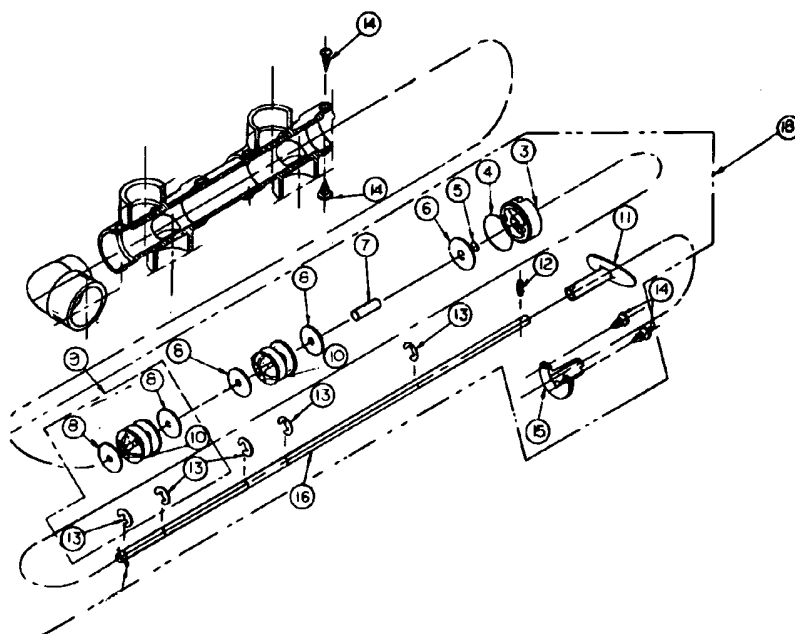

KEY	MFG NO.	DESCRIPTION	ITEM NO.
3	273053	Plug, 2" PVC Piston	OBS
4	273062	O-Ring for Cap	H3338
5	273060	O-Ring for Shaft	H3336
6	273070	Washer, 3/8" Diameter	H3342*
8	273061	Washer, 3/8" S.S. (4 needed)	OBS
9	273028	Piston Half Replacement Kit	H3325*
10	273059	Piston O-Ring (2 needed)	H3335
11	273089	Tee Handle (Replaces 27-3065)	H3326
12	273063	Pin, 1/8" x 1-1/8" S.S. Locking	H3339
13	273057	Retainer Clip (5 needed)	H3333*
14	273071	Screw S.S. (4 needed)	H3343
15	273064	Position Bracket	H3340
16	273235	Shaft, 3/8"-14 x 1/4"	OBS
18	273241	Piston Rod Assembly	H3366

* Limited Quantity

American by Pentair

Baskets are often available in 3 ways. Regular, Heavy Duty, and OEM.

Bronze
Generic: K7177



Maxim
OEM: K3883



Ultra Flo
*Heavy Duty: K9986
OEM: K3835



*Shown

Anthony

Anthony
5 inch Generic: K7106
*5 inch OEM: K3435
6 inch Generic: K7107



*Shown

Aquaflo

Flo Master

*OEM: K5561
Large Hole: K7034
Small Hole: K7101



*Shown

Dominator

*OEM: K5529
Generic: K7199



*Shown

Hayward

Powerflo (LX, LX II)

Generic: K7220
*OEM: K6142



*Shown

Powerflo Matrix

OEM: K6141

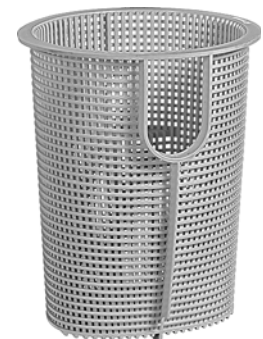

Super Pump

Generic: K7167
Heavy Duty: K9980
*OEM: K4301



*Shown

Super Pump II

Generic: K7207
Heavy Duty: V60-300
*OEM: K4425



*Shown

Northstar

Generic: K7218
*OEM: K4483



*Shown

TriStar OEM: K6306

Maxflo After 1995
OEM: L4231



Hayward Continued

Hayward Powerflo (1500,1700, LX and Old Maxflo

Generic : K7169
*OEM : K6140



*Shown

Jacuzzi

Cygnets

OEM: H8172



LR Series

OEM: H8171



Magnum

OEM: H8519



Magnum Force

*OEM
(After 2003 - 12"): K8200

OEM
(Before 2003 - 9"): K8253

*Shown



Jandy (JHP / JHPU/ Stealth)

OEM: K2590



Pentair

Challenger

Generic: K7219
Heavy Duty: K9985
*OEM: K4628



*Shown

Challenger (3 HP Full Rate (SS))

OEM: K4642



Dynamo

Generic: K7101
*OEM: K4600



*Shown

Pinnacle

OEM: K4678



Purex by Pentair AQ & Whisperflo

Generic: K7199
Heavy Duty: K9981
*OEM: K9308



*Shown

Sta-Rite by Pentair Dyna Glas & Dyna Max

*Generic: K7215
Heavy Duty: K9983
OEM: K3495



*Shown

Sta-Rite by Pentair Dura Glas II & Max E Glas II

Generic: K7215
Heavy Duty: K9983
*OEM: K3495



*Shown

Sta-Rite by Pentair Dura glas & Max E Glas

*Generic: K7106
OEM: K3435



*Shown

Most Commonly Used Commercial Pump and Trap Baskets

AquaFlo

Aqua Flo 6" AC + ACT

*Generic: K7034
OEM: K5594



*Shown

Aqua Flo 8" AC + ACT

Generic: K7131



Hayward Traps

325 2-1/2" - 3" Flange

Height: 7 - 1/4"
Diameter: 3 - 15/16"

*Generic: K7325
SS: K6148
OEM Brass: K6098

*Shown

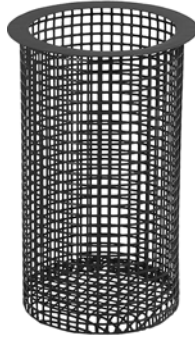

330 4" Flange

Height: 8 - 11/16"
Diameter: 4 - 3/8"

Generic: K7330

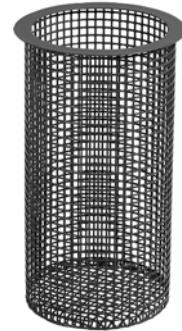

335 5" Flange

Height: 10 - 5/16"
Diameter: 5 1/8"

*Generic: K7335
SS: K6162

*Shown

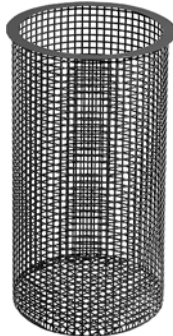

340 6" Flange

Height: 12"
Diameter: 6 - 1/8"

*Generic: K7340
SS: K6168

*Shown



345 8" Flange

Height: 15 - 5/8"
Diameter: 8 - 1/2"

Generic: K7345

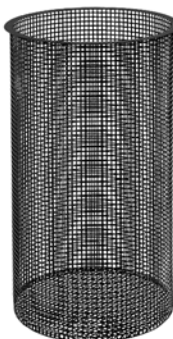

350 6" Flange

1995-Present

Height: 9 - 1/4"
Diameter: 6 - 5/16"

Generic: K7350



Marlow CI Traps

3 - 4" Flange C10X

Height: 9 - 1/8"
Diameter: 7 - 9/16"
Hole: 3 - 13/16"
*Generic: K7134
OEM: K9217

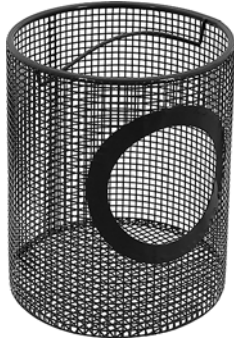

*Shown

5" - 8" Flange D10X

Height: 14"
Diameter: 10"
Hole: 5 - 5/8"
*Generic: K7135
OEM: K9219

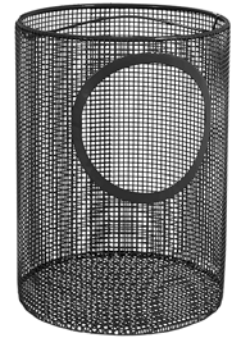

*Shown

Marlow Pumps

5" 2AF - 3 HP

Height: 5 - 3/4"
Diameter: 5 1/8"
*Generic: K7125
OEM: K9208

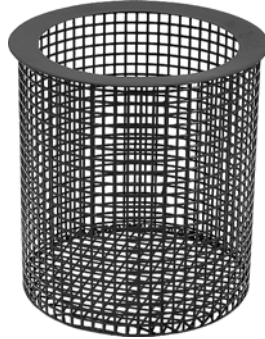

*Shown

8" 3B32EC-C2

Height: 7 - 7/16"
Diameter: 7 - 7/16"
*Generic: K7128
OEM: K9227



*Shown

4SCP Series

Height: 18"
Diameter: 8 3/4"
OEM: K4952



Jacuzzi

3 and 5 HP Magnum Force 3

OEM: K8200



Mermade Fiberglass Traps**Hayward Style 4" Flange**

Height: 14 - 1/2"
 Diameter: 4 - 7/8"
 Item No.: K6500

**Hayward Style 6" Flange**

Height: 18"
 Diameter: 6 - 7/8"
 Item No.: K6501

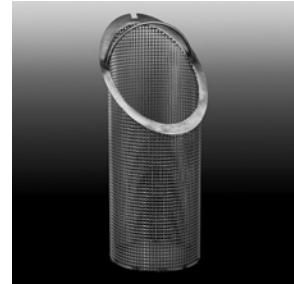
**Hayward Style 8" Flange**

Height: 22"
 Diameter: 8 7/8"
 Item No.: K6502

**Marlow Style 3- 4" Flange**

Height: 11"
 Diameter: 6 - 7/8"
 Item No.: K6520

**Marlow Style 5- 8" Flange**

Height: 16 1/2"
 Diameter: 8 - 7/8"
 Item No.: K6522

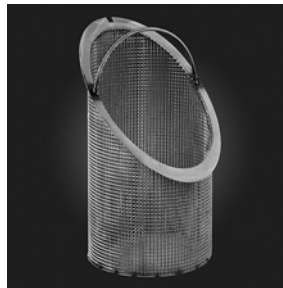

Pentair - Purex - Sta-Rite

Challenger 5 HP

OEM: K4681



EQ

OEM: K3733



Purex C

Generic: K7150

*OEM: K9342

*(Shown)



Sta-Rite CSP

OEM: H1480



Sta-Rite D - 6"

Height: 4 - 13/16"

Diameter: 4 - 7/8"

Generic: K7034



Sta-Rite D-8"

Height: 6 - 15/16"

Diameter: 6 - 3/4"

*Generic: K7120

OEM: K3513

*(Shown)



Premier / Martin

Premier / Martin

Height: 6 - 3/4"

Diameter Rim: 7 - 1/2"

Diameter Body: 6 - 1/2"

OEM: K1808



